



## NEW TRENDS FOR ANGLE OF ARRIVAL ESTIMATION

Dr. Bassim Sayed Mohammed<sup>1</sup>, \*Hadeer Hussein Ali<sup>2</sup>

- 1) Lect., Electrical Engineering Department, University of Technology, Baghdad, Iraq.
- 2) M.Sc. student, Electrical Engineering, University of Technology, Baghdad, Iraq.

**Abstract:** The Angle Of Arrival (AOA) estimation of radio signal gained a high attention, and effort at last 20 years, since it is a very important tool for security purpose and for military operations, it is considered as an essential part of Electronic Warfare activities. Many techniques had been used for AOA like amplitude comparison, time difference, and the phase difference between two pairs of array antenna. The most relevant techniques are (MUSIC) and (ESPIRT). These techniques suffer from many draw back points, like the needs for intensive calculation complexity and high speed processers. Moreover, they are suffering from the lack of audio channel for the estimated signals because they used spectral estimation by Eigenvalue decomposition technique. In this paper a new system is proposed, where linear adaptive array antenna in conjunction with MSE algorithm to meet the requirement for (AOA) and Signal to Noise Ratio (SNR) estimation of the received radio signal in RF band. The proposed system is mathematically modeled, simulated and analyzed. The tested results are compared with the most recent and well-known MUSIC technique. The estimation results of the proposed system show that the proposed system fulfills the most estimation design requirements. From the accuracy and the angular resolution capability point of view, the proposed system exhibits AOA accuracy very close to MUSIC technique, while the angular resolution performance of MUSIC shows better results than the proposed system. The advantage of the proposed system over MUSIC technique, is its ability to estimate the output SNR for the receiving signals as well as AOA while MUSIC technique cannot estimate the output SNR. The proposed system estimates multiple receiving signals sequentially (one by one) while the MUSIC technique estimates them simultaneously. It is also found that the number of estimate signals by MUSIC technique is governed by the number of array and the maximum number must be less than the number of array sensors by one, while the proposed system is not limited to any number of receiving signals, since it estimates the receiving signals sequentially.

**Keywords:** Angle of Arrival Estimation; MUSIC; Adaptive Array Antenna System; Signal to Noise Ratio

### الاتجاهات الجديدة لتخمين زاوية الوصول

**الخلاصة:** المحسوبة سابقاً. وتم مقارنة النتائج مع أحدث الأنظمة المشهورة في تخمين زوايا الوصول وهي منظومة (MUSIC). نتائج حالات المحاكاة أظهرت بأن النظام المقترح حقق أغلب المتطلبات التصميمية لعملية تخمين زوايا الوصول من جهة دقة التخمين والقابلية على التفريق بين مواقع مصادر الإشارات المستلمة. النظام المقترح أعطى نتائج تخمين الزوايا قريبة جداً من نتائج منظومة (MUSIC) بينما دقة تفريق الزوايا لمنظومة (MUSIC) هي أفضل من دقة التفريق للنظام المقترح. أن أهم مزايا النظام المقترح نسبة إلى منظومة MUSIC هي أن النظام المقترح له القابلية على تخمين نسبة الإشارة إلى الضوضاء في خارج النظام للإشارة المستلمة والمخمنة زواياها بينما منظومة MUSIC ليس لها القدرة على تخمين نسبة الإشارة إلى الضوضاء للإشارات المستلمة. النظام المقترح يقوم بتخمين زوايا الوصول للإشارة المستلمة تسلسلياً أي بالتعاقب الواحدة بعد الأخرى وهذا يستغرق وقت أطول مما تستغرقه منظومة MUSIC التي تخمن زاوية الوصول لكافة الإشارات بشكل متوازي. أن أعداد الإشارات المستلمة التي يستطيع نظام MUSIC تخمين زواياها تكون أقل من أعداد عناصر هوائيات المصفوفة بمقدار واحد (M-1) في حين لا حدود لأعداد الإشارات المخمنة في حالة النظام المقترح لأن تخمين الزوايا يكون بالطريقة المتسلسلة.

\*Corresponding Author [haderhussen.ali@yahoo.com](mailto:haderhussen.ali@yahoo.com)

## 1. Introduction

Angle of arrival (AOA) estimation has gained a great interest in the research community. It is generally required to determine the location of the signal emitter from an initial determination of the angle-of-arrival (AOA) of the received signal. AOA estimation requirements are growing up to fulfill the need for locating and tracking signal sources in both military and civilian applications, such as sonar, communication, navigation and radar applications[1]. Many algorithms and techniques are used to estimate the AOA such as classic subspace and Maximum Likelihood (ML) algorithm [2, 3, 4], ML algorithm is one of the first techniques applicable for DOA estimation, but it requires intensive calculation complexity [5]. Classical angle of arrival estimation algorithms such as Multiple Signal Classification (MUSIC) and Estimation of Signal Parameter via Rotational Invariant Technique (ESPRIT) provide better parameter estimation performance and demanded Singular Value Decomposition (SVD) or Eigenvalue Value Decomposition (EVD) for covariance matrix of received signal [6]. The using of these techniques requires high calculation complexity and high cost, especially when the number of antenna element is large [7].

The major advantages of MUSIC and ESPRIT algorithms are high resolution estimates for direction of arrivals (DOAs) and frequencies, while the calculation complexity compared with the ML method less dramatically [8]. MUSIC algorithm demanded multiple dimensional spectral peaks searching, although this search is computationally expensive [9], the primary advantage of ESPRIT algorithm that has reduced computational complexity because it is not required spectral peak searching such as MUSIC algorithm [10]. In this paper we propose to use a modified adaptive antenna, since it has many advantages over the other techniques. The proposed system does not need a hardware network for orthogonality between channels or software programming for eigenvalue decomposition technique like MUSIC and ESPIRT technique [11], so that it is simple, cheap and efficient AOA estimation technique.

The proposed adaptive antenna system as an AOA estimator is shown in Fig. (1). The system is formed by a set of M-sensors followed by Radio unit to convert the radio frequency signal (RF) to an intermediate frequency signal (IF) for processing purposes and then fed to beamforming network.

The adaptive control algorithm uses the information from the signal processing unit to produce weights that optimizes the output signal to noise ratio in front of received signals [12]. The optimum weight vector  $W$  is calculated according to the applied algorithm in the processor such as Minimum Mean Squared Error (MMSE), Maximum Signal-to Interference plus Noise Ratio (SINR), Maximum Likelihood (ML), Minimum Noise Variance (MV) [13]. In adaptive beamforming, the radiation pattern of smart antenna is controlled through various adaptive algorithms. Adaptive algorithm dynamically optimizes the radiation pattern according to the changing of electromagnetic environment [14].

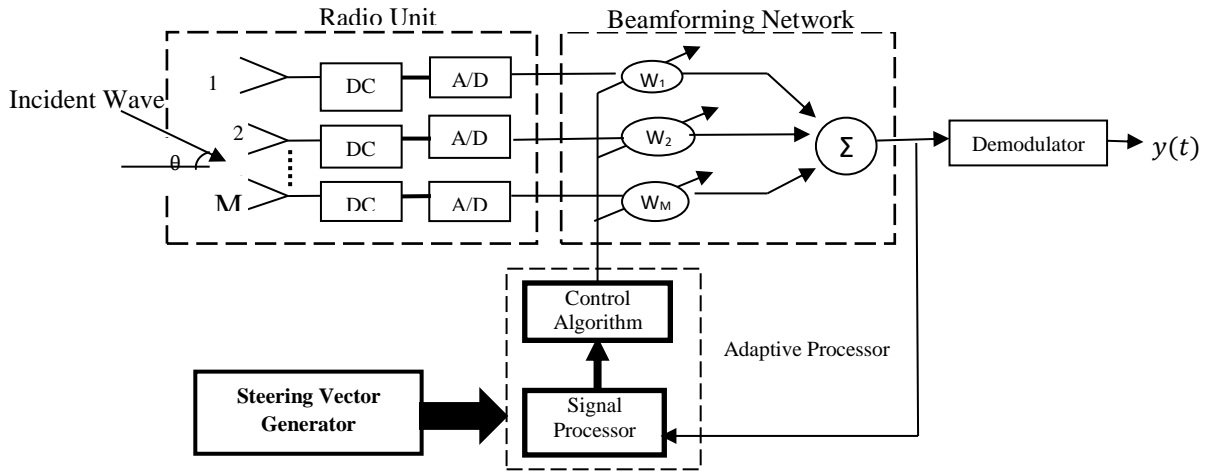

Figure (1): Functional diagram of M-element adaptive array AOA estimator.

### 2. Mathematical Presentation for Basic Aspect

The received signal vector by Uniformly Linear Array Antenna (ULA) with inter-element spacing (d) can be expressed as:

$$X(t) = X_r(t) + X_n(t) \tag{1}$$

where  $X_r(t)$  and  $X_n(t)$  are  $(M \times 1)$  received signal and thermal noise vectors. If the received signal incident at angle  $(\theta_r)$ , then the received signal can be express as:-

$$x_r(t) = A_r e^{j(\omega_o t + \psi_r)} \tag{2}$$

and in vector form is

$$X_r(t) = A_r e^{j(\omega_o t + \psi_r)} U_r(\theta_r) \tag{3}$$

where  $A_r$  is the received signal amplitude,  $\omega_o$  is the angular center frequency,  $\psi_r$  is a carrier phase angle and it is random variable uniformly distributed by  $\psi_r \in [0, 2\pi]$ , and  $U_r(\theta_r)$  is a received signal array vector containing the inter-element phase shift and received signal angel of arrival is equal to :-

$$U_r = [g_1(\theta_r), g_2(\theta_r) e^{-j\beta d \cos(\theta_r)}, \dots, g_M(\theta_r) e^{-j(M-1)\beta d \cos(\theta_r)}]^T \tag{4}$$

where  $g_M(\theta_r)$  is the Mth antenna element field pattern, M is the number of elements and T denotes the transpose.  $\beta$  is the wave number and it is equal to:-

$$\beta = \frac{2\pi}{\lambda} \tag{5}$$

The thermal noise voltage of the array elements is a random signal with zero mean and  $\sigma^2$  variance. The array thermal noise voltages of received signal are mutually uncorrelated and uncorrelated with  $\Psi_r$  and  $X_r$  and it can be expressed as:-

$$X_n(t) = [n_1(t), n_2(t), \dots \dots n_M(t)]^T \quad (6)$$

The adaptive array output signal is:-

$$y(t) = \sum_{j=1}^M w_j x_j(t) \quad (7)$$

equation. (7) can conveniently be expressed in a vector form as

$$y(t) = W^T X = X^T W \quad (8)$$

The weights vector (W) and the input signals vector X are given by

$$W^T = [w_1, w_2, \dots \dots w_M] \quad (9)$$

$$X^T = [x_1, x_2, \dots \dots x_M] \quad (10)$$

The covariance matrix of input signals vector is defined as:

$$Cov[XX^*] = E[(X - E(X))^* [X - E(X)]^T] = R_{gg} \quad (11)$$

### 3. The MUSIC Algorithm for AOA Estimation

Music (multiple signal classification) is a common high resolution AOA estimation technique demands SVD for covariance matrix of receiving signals. It starts by decomposition the covariance matrix of received signals to  $(M - D)$  noise eigenvalues and consequently, the corresponding eigenvectors related to them are given as:-

$$Q_n = [e_1 e_2 \dots \dots e_{M-D}] \quad (12)$$

The remaining D eigenvalues of the covariance matrix  $R_{xx}$  represents the eigenvalues related to the (D) number of receiving signals with their corresponding eigenvectors.

$$Q_D = [e_{M-D+1} e_{M-D+2} \dots \dots e_M] \quad (13)$$

The direction of arrival for receiving signals can be estimated by locating the peaks of the MUSIC spatial spectrum according to the following formula [14].

$$DF(\theta) = \frac{1}{s^H(\theta) Q_n Q_n^H s(\theta)} \quad (14)$$

Where H is the Hermitian matrix,  $s(\theta)$  is a steering vector belonging to  $s(\theta) \in [0, 2\pi]$  and  $Q_n$  is noise subspace eigenvector matrix.

#### 4. Mathematical Model for Proposed AOA Estimator

Fig. (2) shows a linear array antenna uniformly distributed on y-axis used with the MSE adaptive algorithm as a proposed estimator to estimate the azimuth angles ( $\theta$ ) and output SNR for receiving signals.

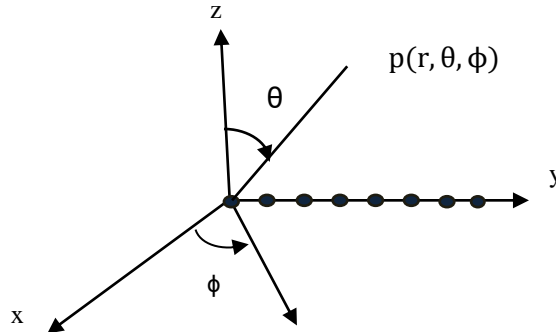

Figure. (2) Uniform linear array geometry for M elements

The error signal  $\epsilon(t)$  shown in Fig. (3) between array output  $y(t)$  and the reference signal (steering vector)  $S(t)$  is calculated according to the following equation:-

$$\epsilon(t) = s(t) - y(t) \tag{15}$$

Where  $y(t)$  is the array output and equal to:-

$$y(t) = W^H X(t) \tag{16}$$

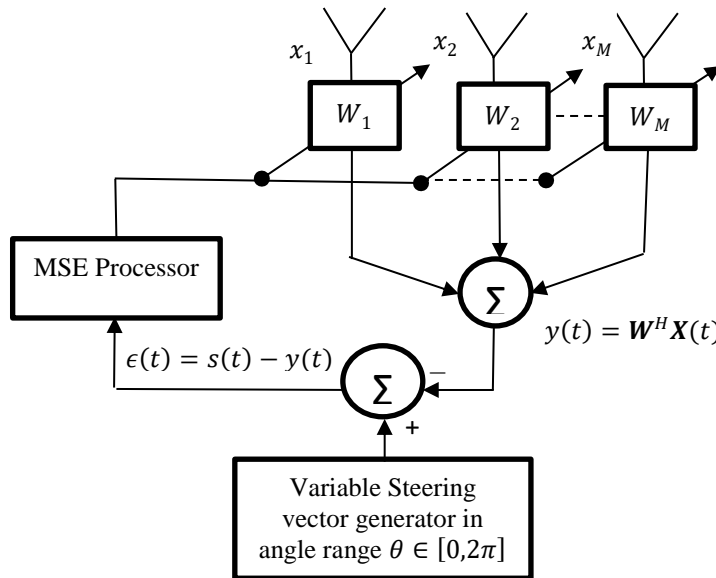

Figure (3): Adaptive array system with mean square error algorithm.

After substituting equation. (16) in to equation. (15) the error signal can be explained as:-

$$\epsilon(t) = s(t) - W^H X(t) \tag{17}$$

The minimum mean square error (MSE) of equation. (17) is equal to

$$\text{MSE} = E\{\epsilon(t)\epsilon^*(t)\} = E\{|\epsilon(t)|^2\} = E\{|s(t) - W^H X(t)|\}^2 \quad (18)$$

Simplifying the expression leads to:-

$$E\{|\epsilon(t)|^2\} = E\{s^2(t)\} - 2W^H E\{X(t)s(t)\} + W^H E\{X(t)X^H(t)\}W \quad (19)$$

$$E\{|\epsilon(t)|^2\} = E\{s^2(t)\} - 2W^H r_{xs} + W^H R_{xx}W \quad (20)$$

Where  $r_{xs}$  is ( $M \times 1$ ) vector representing the cross correlation between the antenna array receiving signals vector  $X(t)$  and steering vectors( $t$ ).The MSE could be applied to minimize the error and thus improve the signal to noise ratio at the receiver output. The optimum solution for minimizing the MSE with respect to the weight vector is:-

$$\nabla_w E\{|\epsilon(t)|^2\} = -2r_{xs} + 2R_{xx}W_{opt} \quad (21)$$

The minimum value of equation. (21) is given by

$$-2r_{xs} + 2R_{xx}W_{opt} = 0 \quad (22)$$

Where  $W_{opt}$  is the optimal weight vector and equal to:-

$$W_{opt}(\theta) = R_{xx}^{-1}(\theta_r)r_{xs}(\theta_s)\text{when}\theta_r = \theta_s \quad (23)$$

The optimum weights vector can be used to draw the field pattern of array system and consequently the minimums of this pattern represent the angles of arrival of these receiving signals according to the following equation:-

$$G_{min}(\theta) = W_{opt}^T(\theta_r)S(\theta_s)\text{when}\theta_r = \theta_s \quad (24)$$

The peaks of receiving signals spectrum represent the angles of arrival and they can be found according to the following formula:-

$$\text{AOA}_{\max}(\theta) = \frac{|S(\theta)|^2}{G_{\min}(\theta)} \quad (25)$$

## 5. The Estimation of Output SNR

Since the optimum weight vector  $W_{opt}$  is calculate according to equation.(25), this weights vector will maximizes the output of the array in the estimated directions of received signals with respect to the noise level. If the output voltage of the adaptive array system due to received signals is denoted by  $y_r(\theta)$  and, due to the thermal noise, channels is denoted by  $y_n$ , then these two output signals can be expressed as [18] :-

$$y_r(\theta) = W^T(\theta)X_r(\theta) = X_r^T(\theta)W(\theta) \quad (26)$$

$$y_n = W^T(\theta)X_n = X_n^T W(\theta) \quad (27)$$

Then the output powers due to these two signals can be written as:-

$$E\{|y_r(\theta)|^2\} = E\{|W^T(\theta)X_r(\theta)|^2\} \quad (28)$$

$$= W^T(\theta)R_{rr}(\theta)W^*(\theta) \quad (29)$$

where  $R_{rr}$  is the autocorrelation matrix of the received signals under AOA estimation and equals to:-

$$R_{rr} = E[X_r^*(\theta)X_r^T(\theta)] \quad (30)$$

Similarly the out power due to thermal noise is

$$E\{|y_n|^2\} = E\{|W^T(\theta)X_n|^2\} \quad (31)$$

$$= W^T(\theta)R_{nn}W^*(\theta) \quad (32)$$

Where  $R_{nn}$  the autocorrelation matrix of thermal noise and it is equal to:-

$$R_{nn} = \sigma_n^2 I \quad (33)$$

where  $\sigma_n^2$  is the second moment of random noise signal and  $I$  is an identity matrix of dimensions  $M \times M$ . Now the estimated output  $SNR(\hat{\theta})$  for each received signals can be calculate according to the following formula:-

$$SNR(\hat{\theta}) = \frac{P_r(\theta)}{P_n} = \frac{E\{|y_r(\theta)|^2\}}{E\{|y_n|^2\}} \quad (34)$$

$$SNR(\hat{\theta}) = \frac{W^T(\theta)R_{rr}W^*(\theta)}{W^T(\theta)R_{nn}W^*(\theta)} \quad (35)$$

## 6. Simulation and Results

The simulation programs were written by MATLAB (version 8.1.0430) and the following assumption were considered.

- The antenna array elements are distributed uniformly along y-axis.
- Array antenna elements are identical and isotropic.
- The inter element spacing between elements are equal to  $0.5\lambda_0$ .

where  $\lambda_0$  is the wave length of center frequency.

The proposed AOA estimator is tested, evaluated and the results of simulation cases are compared to MUSIC technique. The simulation cases are carried out according to the following scenarios:-

Scenario(A) Eight isotropic elements of  $0.5\lambda_0$  interelement spacing, with one received signal arriving from azimuth angle  $90^\circ$  with different to input SNR,  $2dB$ ,  $4dB$ , and  $6dB$  is assumed.

Fig. (3) shows that the output SNR for different receiving signal levels. In this figure it can be shown that the estimated level of output SNR is related to the input level of receiving signal and the angle of arrival (AOA) of this signal is accurately estimated as well as the output SNR level can be explored to calculate how far the transmitting sources are. Fig. (4) for MUSIC technique shows that the level of the output DF function is not sensitive to the receiving signals input levels, this is due to that the

MUSIC DF level depends on the nulls created by noise subspace eigenvectors and not on the received signals levels see Eq.(16).

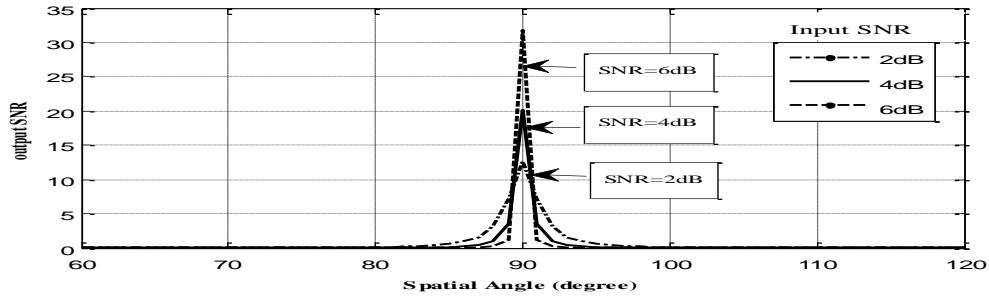

Figure. (3) SNR plot versus spatial angle for proposing estimator.

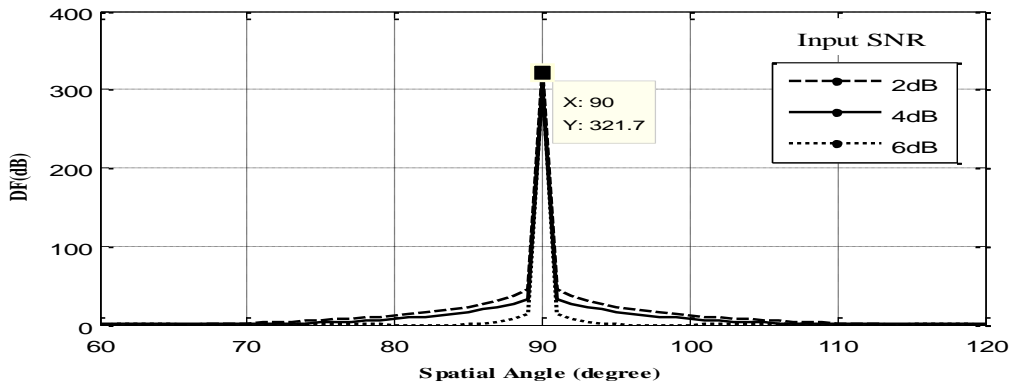

Figure. (4) MUSIC DF plot for MUSIC technique.

Scenario (B) Twelve isotropic elements with  $0.5\lambda_0$  interelement spacing, and four receiving signals arriving from  $\theta_1 = 40^\circ, \theta_2 = 80^\circ, \theta_3 = 120^\circ, \text{ and } \theta_4 = 160^\circ$  with input SNR,s  $SNR_1 = 0dB, SNR_2 = 2dB, SNR_3 = 4dB, \text{ and } SNR_4 = 6dB$  are assumed.

Figure (5) and (6) shows the output SNR and DF plots. These plots indicate that the propose system has a capability to estimate the AOA,s as well as the output SNR,s for all receiving signals, while the MUSIC DF plot shows only the AOA,s estimation for these receiving signals with approximately equal levels while the levels of output SNR,s for proposed estimator is proportional to the input levels.

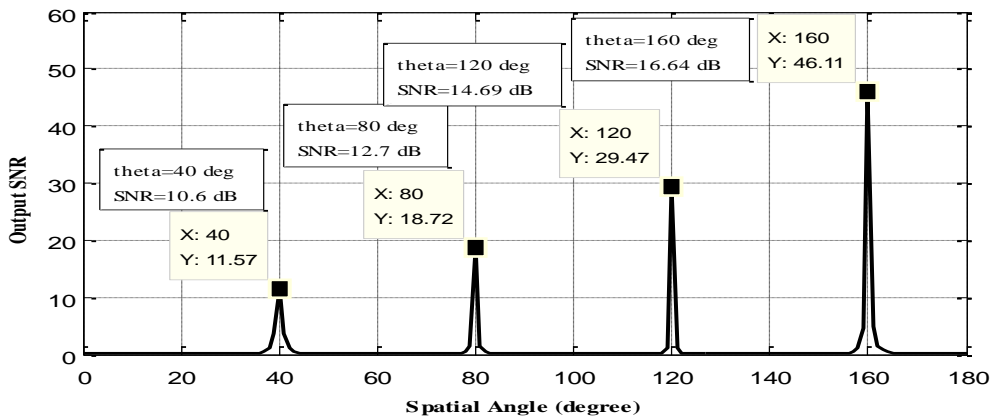

Figure. (5) Output estimated SNR,s plot for proposed estimator.



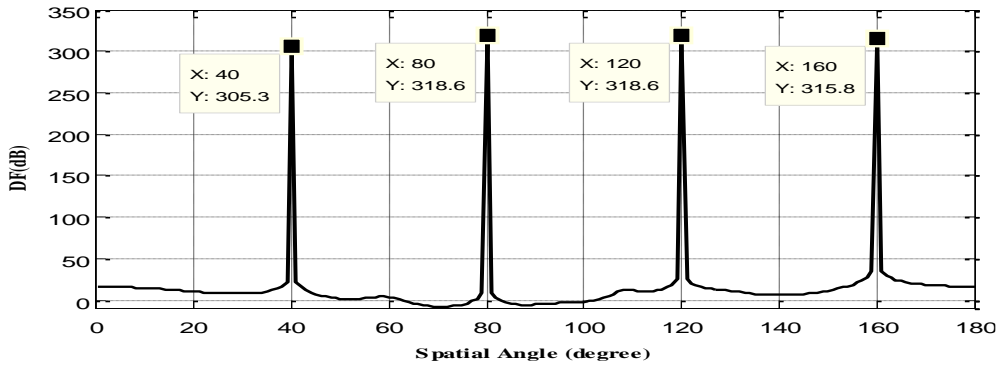

Figure. (6) MUSIC DF estimated plot.

Scenario (C) Six isotropic elements with  $0.5\lambda_0$  interelement spacing, are subjected to eight receiving signals arriving from  $\theta_1 = 30^\circ, \theta_2 = 70^\circ, \theta_3 = 110^\circ, \theta_4 = 150^\circ, \theta_5 = 210^\circ, \theta_6 = 250^\circ, \theta_7 = 290^\circ, \theta_8 = 330^\circ$ , with equal input SNR, s 10dB

Fig (7) shows that, the proposed estimator, estimates output SNR, s and AOAs of all receiving signals, although their numbers are greater than the number of array sensors, while MUSIC technique is failing to estimate the AOA of all receiving signals, this is because the propose AOA estimator estimates the received signals sequentially (one by one), but MUSIC technique estimates them simultaneously, and according to the MUSIC algorithm the maximum number of estimated signal (D) must be less than the number of array elements (M) at least by one.

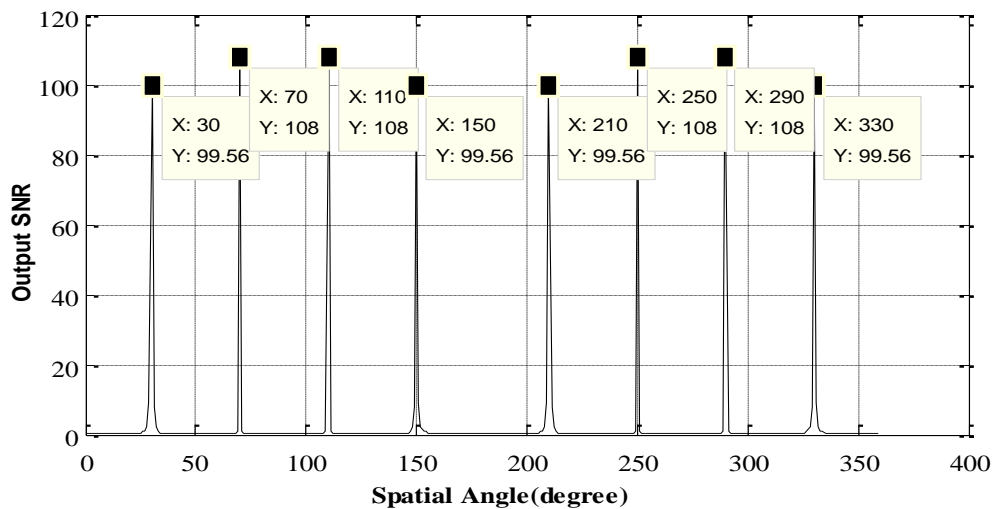

Figure (7): SNR plots for proposed estimator.

Scenario (D) Eight isotropic elements with  $0.5\lambda_0$  interelement spacing are impinging by two signals arriving from  $\theta_1 = 90^\circ, \theta_2 = 94^\circ$  with equal input SNR, s 10dB

Fig. (8) shows that the angular resolution  $\Delta\theta$  of the proposed estimator is  $4^\circ$  while Fig(9) for MUSIC shows  $2^\circ$ , that is because MUSIC technique is a high angular resolution technique while the proposed AOA estimator depends on the number of array sensors and interelement spacing (i.e the width of mainlobe).

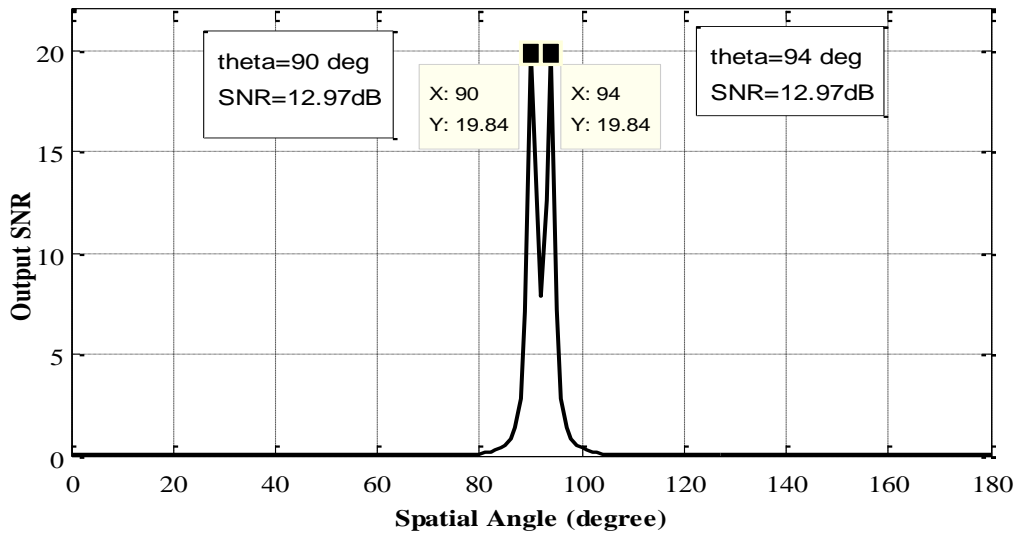

Figure (8) SNR plots for proposed estimator.

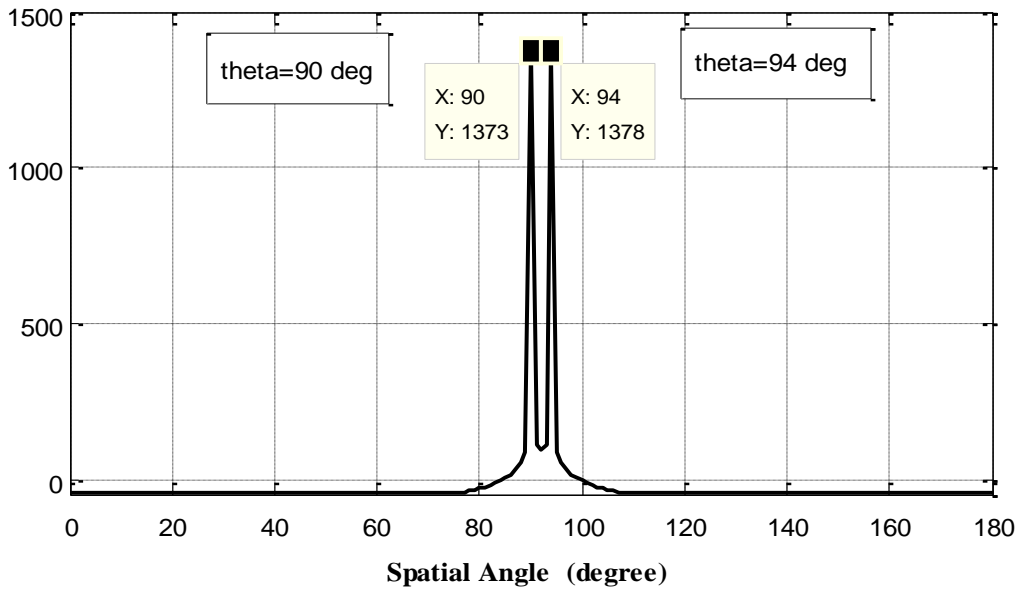

Figure. (9) MUSIC DF plot.

Scenario (E) verifying the relationship between the angular resolution of proposed AOA estimator and the number of array antenna elements used by the estimator for different interelement spacing  $0.25\lambda_0$ ,  $0.5\lambda_0$  and  $0.75\lambda_0$ .

Figure (10) show that the angular resolution of proposed estimator is improved when the interelement spacing is increased and when the number of array sensor is increased, that is because the main lobe beamwidth will be more sharper since it is invervesly proportionalto the interelement spacing and number of array sensors.

Due to this sharpness the angular resolution of the proposed estimator is improved according [18].

Table(1): Relationship between the angular resolution and the number of array sensors for different interelement spacing for the proposed estimator.

Number of array sensor (M)	Angular resolution $\Delta\theta$ for $d = 0.25\lambda_0$	Angular resolution $\Delta\theta$ for $d = 0.5\lambda_0$	Angular resolution $\Delta\theta$ for $d = 0.75\lambda_0$
4	30°	16°	10°
5	25°	10°	7°
6	18°	8°	5°
7	15°	6°	4°
8	13°	5°	3°
9	10°	4°	2.5°
10	8°	3.5°	2.5°
11	7°	3°	2°
12	6°	3°	2°
13	5°	2.5°	1.5°
14	4.5°	2.5°	1.5°
15	4°	2°	1.5°
16	3.5°	2°	1°
17	3.5°	2°	1°
18	3°	1.5°	1°
19	3°	1.5°	1°
20	2.5	1.5	1
21	2.5	1.5	1
22	2	1	1

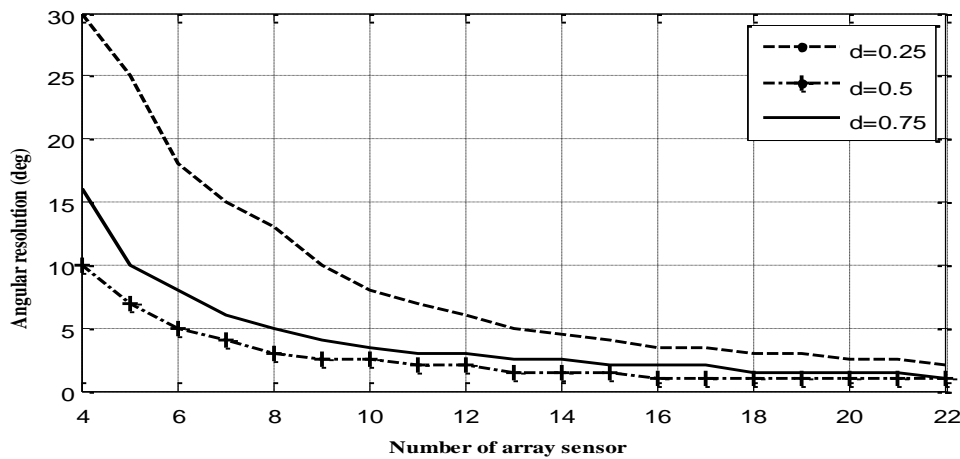

Figure. (10) Angular resolution versus number of array sensors for the proposed estimator.

### 7. Conclusions

In this paper a proposed angle of arrival estimation system is developed by using linear adaptive array system for estimating azimuth or elevation angles and output SNR,s at the same time. The estimation results show that the AOA estimation accuracy of the proposed system is very close to that of the MUSIC techniques accuracy. It is

also found that the proposed system can estimate the output SNR of the received signals as well as the azimuth or elevation angles in the same time, while MUSIC technique can only estimate azimuth or elevation angles. The results indicate that estimated output SNR is directly proportional to the input powers of receiving signals. The output DF function of the MUSIC technique exhibit fixed level, regardless input levels, this is due to the fact that the DF function of the MUSIC technique depends on the nulls created by the noise subspace eigenvectors and not on the input levels of receiving signal.

It is also found that the proposed system can estimate a number of received signals greater than the number of array sensor because it estimates them one by one (sequentially) while MUSIC technique can estimate (M-1) sources only, since it estimated them simultaneously. It is found that the proposed system has a significant advantage point over MUSIC technique by offering a capability to listen to the receiving signals under estimation process and this facility is very important in Electronic Warfare Field. Finally the complexity and cost of the proposed system from software and hardware point of view is less than the cases of conventional systems like MUSIC and ESPRIT.

### Abbreviations

$A_r$	received signal amplitude
$d$	interelement spacing between antenna elements
$D$	number of received signal sources
$d_r(t)$	reference signal
$E\{. \}$	the expected value
$e_i$	ith eigenvector associated with the ith eigenvalue
$G(\theta)$	adapted field pattern
$g_M(\theta_r)$	antenna element field pattern
$I$	identity matrix
$P_r(\theta)$	power of the received signal at array output
$P_n$	thermal noise power at array output
$Q$	nonsingular orthonormal transformation matrix
$Q_s$	eigenvector sub-matrix related to signal subspace
$Q_n$	eigenvector sub-matrix related to noise subspace

$R_{xx}$	auto-correlation matrix for received signals
$R_{nn}$	auto-correlation matrix for channel thermal noise signal
$s(t)$	steering vector
$U_r$	received signalarray vector
$W(0)$	the initial weight vector
$W_{opt}$	optimum weight vector
$x_j(t)$	jth input signal
$X(t)$	input signal vector
$X_r(t)$	received signal vector
$X_n(t)$	thermal noise vector
$y_r(k)$	array output voltage due to received signal
$y_n(k)$	Array output voltage due to thermal noise
$\beta$	wave number
$\Lambda$	eigenvalues diagonal matrix
$\mu$	step size for iteration loop
$\sigma^2$	variance of thermal noise (noise power)
$\psi_r$	carrier phase angle
$\omega_r$	RF switch angular frequency
$\omega_o$	center angular frequency
$\epsilon(t)$	error signal
$\{.\}^T$	transpose of vector.
$\{.\}^*$	conjugate
$(.)^\sim$	orthogonalized quantity
$[.]^{-1}$	Inverse matrix
$\nabla_w$	gradient opertator

## 8. Reference

1. Palan.N. G, Barbadekar. B. V, August (2016) "*Performance Analysis Of Angle Of Arrival Estimation Algorithms For Smart Antenna In Wireless Sensor Networks: An Optimization Approach*", International Journal of Computer Application (IJCA), Vol. 148, No. 14
2. Lee.J. H. and Woo.J. M, (2015) "*Interferometer Direction-Finding System with Improved DF Accuracy Using Two Different Array Configurations*", IEEE Antennas and Wireless Propagation Letters, Vol. 14, No. 12 pp. 719 – 722.
3. Orul.T and Afacan.E, August (2013) "*Estimation of Direction of Arrival Algorithms*", Progress In Electromagnetics Research Symposium Proceedings (PIERS), Stockholm, Sweden, pp.1346-1351, Vol. 4, No. 3.
4. Naaz.A and Rao.R, March (2014) "*DOA Estimation a Comparative Analysis*", International Journal of Computer and Communication Engineering, Vol. 3, No. 2.
5. Al-Azzo.M. F and Al-Sabaawi.K. I, (2014) "*High Resolution Techniques for Direction of Arrival estimation of Ultrasonic Waves*", American Journal of Signal Processing, pp. 49-59.
6. Kumbar.K. A, June.(2015) "*Adaptive Beamforming Smart Antenna for Wireless Communication System*", International Research Journal of Engineering and Technology (IRJET), Vol. 2, No.3, pp. 2038-2043.
7. Anwar.M, Gaga.T. S and Bohra.G. K, (2014) "*Direction of Arrival in Smart Antenna using Different Types of Uniform Array Configuration*", International Journal of Computer Applications, National Conference on Innovations and Recent Trends in Engineering and Technology (NCIRET), Vol. 5, pp.1-5.
8. Khmou.Y, Safi.S, and Frikel.M, (2014) "*Comparative Study between Several Direction of Arrival Estimation Methods*", Journal of Telecommunications and Information Technology, pp. 41.48.
9. Foutz.J, Spanias.A, and Banavar.M. K, (2008) "*Narrowband Direction of Arrival Estimation for Antenna Arrays*", Synthesis lectures on antennas by Morgan and Claypool.
10. Chen. Z, Gokeda. G. and Yu.Y, (2010) "*Introduction to Direction-of-Arrival Estimation*", Artech House, ch.1, pp.13-14.
11. Saxena.P and Kothari.A.G., (2014) "*Performance Analysis of Adaptive Beamforming Algorithms for Smart Antennas*", International Conference on Future Information Engineering, Vol.10, pp.131-137.
13. Joshi.R. and Dhande.A, May, (2014) "*Adaptive Beamforming Using LMS Algorithm*", International Journal of Research in Engineering and Technology, Vol.3, N.5, pp. 589-593.
14. Bakhar.M, V. R.M and Hunagund.P.V, November,( 2009), "*Eigen Structure Based Direction of Arrival Estimation Algorithms for Smart Antenna Systems*", International Journal of Computer Science and Network Security (IJCSNS), Vol. 9, No.11, pp.96-100.
15. Monzingo.R. A, Miller.T. W, (2011) "*Adaptive Arrays principles*", 2<sup>nd</sup> Edition, SciTech Publishing.

16. Kale.A. R, June, (2015) "*Subspace Based DOA Estimation Techniques*", International Journal of Research in Engineering and Technology (IJRET), Vol. 4, No. 6, pp.560-564.
17. Balasem.S.S, Tiong.S. K, and Koh.S. P., May, (2012) "*Beamforming Algorithms Technique by Using MVDR and LCMV*", World Applied Programming Special section for proceeding of International E-Conference on Information Technology and Applications (IECITA), Vol.2, No.5, pp.315-324.
18. Banerjee.S. and Dwivedi.V. V,(2013)"*An LMS Adaptive Antenna Array*",International Journal of Advanced Research in Engineering and Technology (IJARET), Vol.4, No. 6,pp.166-174.
19. Stutzman.W. L. and Thiele.G. A, (1981), "*Antenna Theory and Design*", John Wiley and Sons, New York.