



EFFECT OF SPACING BETWEEN SHEAR CONNECTORS ON THE BEHAVIOR OF COMPOSITE CONCRETE STEEL BEAMS UNDER PURE TORSION

Ali Sabah Ahmed¹, Laith Shakir Rasheed², *Ali Abdulrazaq Abdulredha³

- 1) Assist. Prof., Civil Engineering Department, Al-Mustansiriyah University, Baghdad, Iraq.
- 2) Assist. Prof., Civil Engineering Department, Karbala University, Baghdad, Iraq.
- 3) student master ., Civil Engineering Department, Al-Mustansiriyah University, Baghdad, Iraq

(Received: 23 /11 /2014 ; Accepted: 24 /2/2015)

Abstract: A strengthen method that was used quite extensively during the mid 1970s is steel plate bonding, this method has gained renaissance in the last decades. This paper presents experimental work includes investigation of four simply supported reinforced concrete beams under pure torsion. The first beam was the control beam without strengthening. The other three beams were strengthened externally by bolted steel plates. The most important variable was the spacing between shear connectors .The discussion of results are based on torque-twist behavior, beam longitudinal elongation behavior and the influence of the spacing between shear connectors on cracking torque, ultimate torque and failure modes.

Keywords: Torsional Reinforced Concrete, Shear Connector, Composite Concrete Steel Beams.

تأثير المسافات الفاصله بين روابط القص على تصرف العتبات الخرسانية المركبة مع الحديد تحت تأثير عزوم الي

الخلاصة: تعتبر طريقة تقوية العتبات الخرسانية المسلحة بصفائح فولاذية خارجية من الطرق الشائعة بالرغم من بعض العيوب. ان هذا البحث يتضمن التحريات لأربعة عتبات خرسانية مسلحة تحت تأثير عزم الي النقي. أدى هذه العتبات هو عتبة السيطرة وهذه العتبة بدون تقوية. والعتبات الثلاثة الأخرى تم تقويتها خارجياً باستخدام صفائح حديدية تم ربطها خارجياً باستخدام روابط القص (shear connectors). اهم المتغيرات التي تم التحري عنها لمعرفة تأثيرها على تصرف العتبات الخرسانية المقواة هي مسافات التباعد بين روابط القص (shear connectors).تم مناقشة نتائج الفحص اعتماداً على تصرف عزم الي- زاوية الدوران، وإستطالة العتبات وتأثير مسافات التباعد بين روابط القص على عزم لي التشقق و اللي الأقصى وأطوار الفشل.

1. Introduction

In civil engineering construction, the aim of using or selecting any material is to make full use of its properties in order to get the best performance for the formed structure. Availability, structural strength, durability and workability, all these factors are required for the construction material in any modern structural engineering application [1].

*Corresponding Author dralisabah@yahoo.com

The properties of each material differ from the properties of another material; thus there is no material that can provide all the structural requirements. This is the reason for using two or more materials and connecting them together in order to make full advantage of their properties in getting one structural element that uses the desirable properties of the materials. The advantage characteristics of different materials are combined to produce a member with high carrying capacity. Then, the structural member of two or more materials is known as a composite member [2].

Although the word composite may refer to all kinds of different materials connected together, in this study the term composite construction means steel plates attached to a reinforced concrete beams by means of mechanical connectors. The functions of these connectors are to transfer the forces between the two components, thus sustaining the composite action.

Composite reinforced concrete–steel members in a structure may be subjected to axial forces, shear forces, bending moments, torque, or a combination of these effects. Most of the previous studies were focused on the influenced of steel plates on the flexural behavior of conventional concrete beams, where the steel plate was attached to their bottom face by using epoxy or by bolting technique. Studies on torsional behavior of composite concrete-steel beams using steel plates are limited, and to a certain degree controversial. So that to increase the experimental database on torsional behavior of composite concrete-steel beams the present research will be tested composite reinforced concrete-steel beams under pure torsion.

2. Research Objective

The objective of this investigation is to evaluate the effectiveness of the spacing between shear connector on the behavior of composite reinforced concrete – steel beams subjected to pure torsion. Discussions are presented regarding the cracking torque, ultimate torque, mode of failures, angle of twist of the beams and beams longitudinal elongations.

3. Experimental Program

Structural members curved in plan, members of a space frame, eccentrically loaded beams, curved box girders in bridges, spandrel beams in buildings, and spiral stair-cases are typical examples of the structural elements subjected to torsional moments as shown in Fig. 1 and torsion cannot be neglected while designing such members. Structural members subjected to torsion are of different shapes such as T-shape, inverted L-shape, double T-shapes and box sections. These different configurations make the understanding of torsion in RC members a complex task. In addition, torsion is usually associated with bending moments and shearing forces, and the interaction among these forces is important. In order to improve the level of understanding of the effectiveness of strengthening of RC beams for torsion and to simplify the torsional characteristics, in the current study only square cross sections subjected to pure torsional moment were investigated.

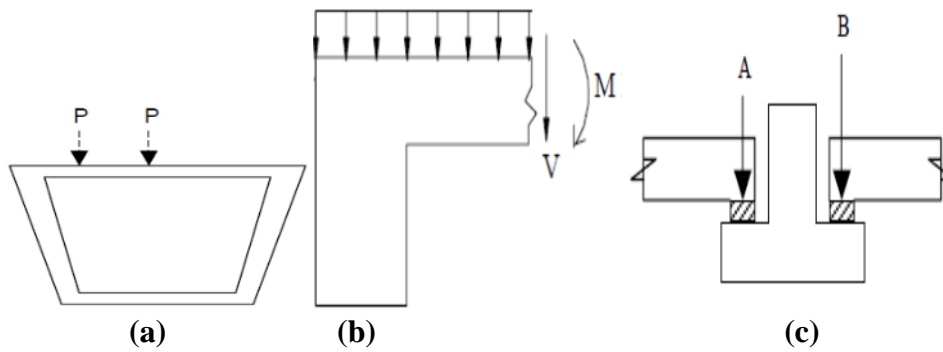
Figure (1): Examples of torsion in structural members ^[3]

a: Inverted - T beam supporting pre-cast floor slabs.

b: Spandrel beam

c: Box girders.

3.1. Test Beams

The experimental program consists of testing four composite reinforced concrete-steel beams subjected to pure torsion. One of these beams was a reinforced concrete beam without externally strengthening it was test as reference beam (BN), the other three beams were a composite beams where the reinforced concrete beams strengthened by externally steel plate which connected to both sides of the beam. All the tested beams have the same dimensions which are 100mm width, 200mm height and 1500mm length. The compressive strength of all beams tested is almost the same of (30MPa) value as well as similar steel plate thickness and steel plate area. Farther more, constant steel reinforcement are used in all composite concrete-steel beams are similar with ($\rho = 0.91\%$) and with spacing between closed stirrups of (80mm) c/c. The spacing of stirrups as well as the reinforcement ratio and the limitations of reinforcement was according to ACI Code 318-95 [4]. The main variable conducted throughout the test program was the spacing between shear connectors which was (50mm) in (B1), (75mm) in (B2) and (100mm) in (B3). The typical bolts distributions of the steel plates were shown in figure (2).

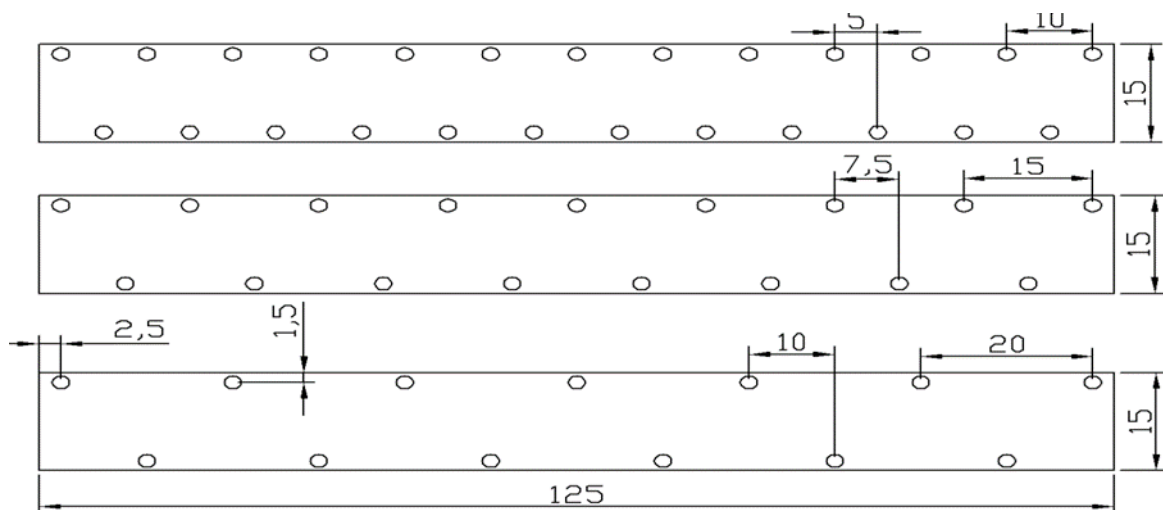

Figure (2) Typical Bolts Distribution of the Steel Plates [all dimensions in centimeter (cm)]

3.2. Specimens Reinforcement

The steel reinforcement of the tested beams consisted of two 10 mm diameter bars at the bottom and two 10 mm diameter bars at the top of the beam used as anchor bars. Shear reinforcement was provided in the form of two-legged rectangular stirrups with standard hooks. Stirrups were made of 6 mm diameter bars. The stirrups were 70 mm wide and 150 mm in depth. The center-to-center spacing of the stirrups was 100 mm. Figure (3) shown the details of steel reinforcement in the reinforced beams. The yield stress, ultimate strength and longitudinal elongation of steel reinforcing bars used in this study are summarized in Table (1).

Table (1): Specification and Test Results of Steel Reinforcing Bar Values

Diameter of Bar (mm)	Measured Diameter (mm)	Yield Stress ^(*) (N/mm ²)	Ultimate Strength (N/mm ²)	Elongation %
8	8	496	612.9	17
10	10	521	615.7	19

(*) Each value is an average of three specimens.

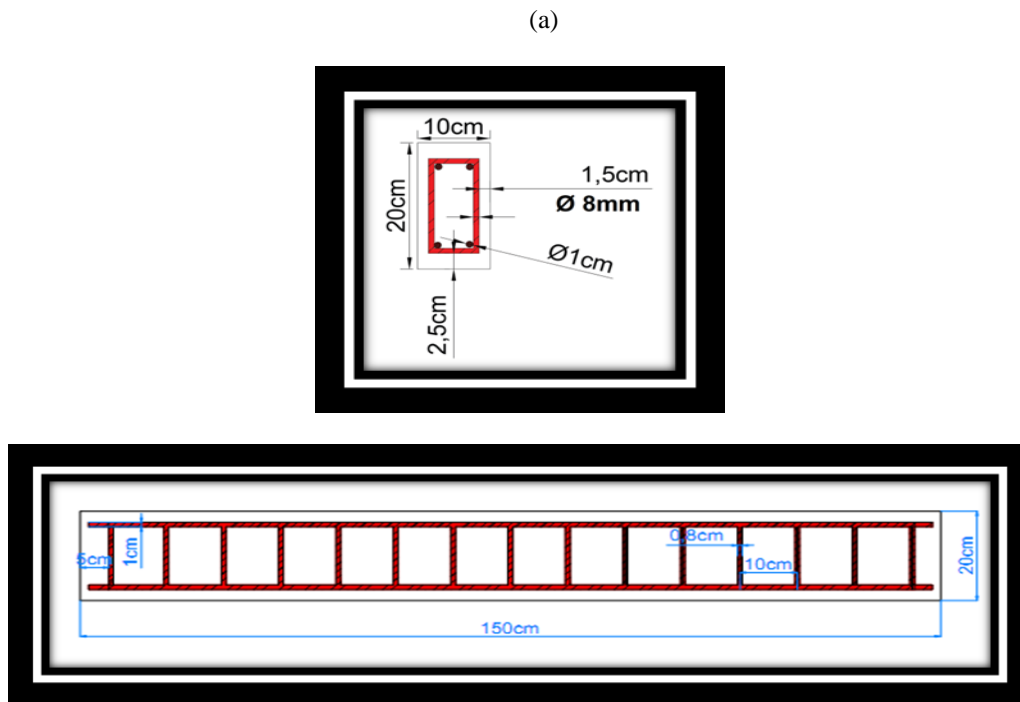

Figure (3): Details of Beams Reinforcement

(a) Cross Section of Steel Reinforcement.

(b) Reinforcement Profile along the Beam.

3.3. Steel Plates Properties

The externally strengthening which used in the present study were steel plate with (2mm) thickness, (1250mm) length , (150mm) height. Table (2) explained the yield stress, ultimate strength and longitudinal elongation of steel plate used in this study.

Table (2): Specifications and Tensile Test Results of Steel Plates

<i>Steel Specimens</i>	<i>Thickness of Plates (mm)</i>	<i>Yield stress (N/mm²)</i>	<i>Ultimate strength (N/mm²)</i>	<i>Elongation (%)</i>
Steel Plates	2	386.3	426.6	15.2

3.4 Mechanical Shear Connectors

Different types of shear connectors are available in practice. The most widely used type of connectors is the head stud. This type is used in this study with diameter (8 mm) and length (45 mm). The test used is direct- shear strength and the aim of this test is to know the ultimate shear strength of the bolt.

The connectors were tested under direct shear strength test. This test is carried out on stud connectors by using two channels [80*40*6 mm] welded as box and placed inside external box which made of welding two channels of dimensions [100*50*6 mm], after that three holes are made on each side and the same distance, as shown in Figure (4). The procedure of this test is by putting two bolts; one is on each side and applied the load slowly until failure. The observed mode of failure was the cutting of the bolt at the interface. The average shear force is (17.5) kN.



Figure (4) The direct- shear strength test

3.5 Testing Procedure

All reinforced concrete beams have been tested using a Universal Testing Machine model (8551 MFL system) with a maximum capacity of 300 tons, This machine was calibrated by the "Iraqi central organization for standardization and quality control". The beams were placed in the machine on free supported rollers at each end with clear span of 1400mm. The equipment and other accessories for the manufacturing and testing arrangement of the tested beams were all available in the Structural laboratories, Engineering College of Al-Mustansiriyah University.

The MFL testing machine is capable of applying vertical load on the specimen at several points but the supports for the loading of this investigation should remain in position without rotating around the longitudinal axis of the beam. In this research the loads were applied outside the bed of the universal machine to get torsion. The supports were designed to be able on rotating around the longitudinal axis of the beam to allow free torsion application. This was achieved through the transmission of the applied load from the center of the universal machine to the two external points representing the moment arm, Figure (5).

The special clamping loading frame on each end of the beam used in this research is shown in Fig. (5) This frame consists of two large steel clamps which work as arms for applied torque with separated faces to connect them over the sample by large bolts, four bolts were used for each arm. This frame is made of thick steel plate (12 mm) with two steel shafts attached by screws.

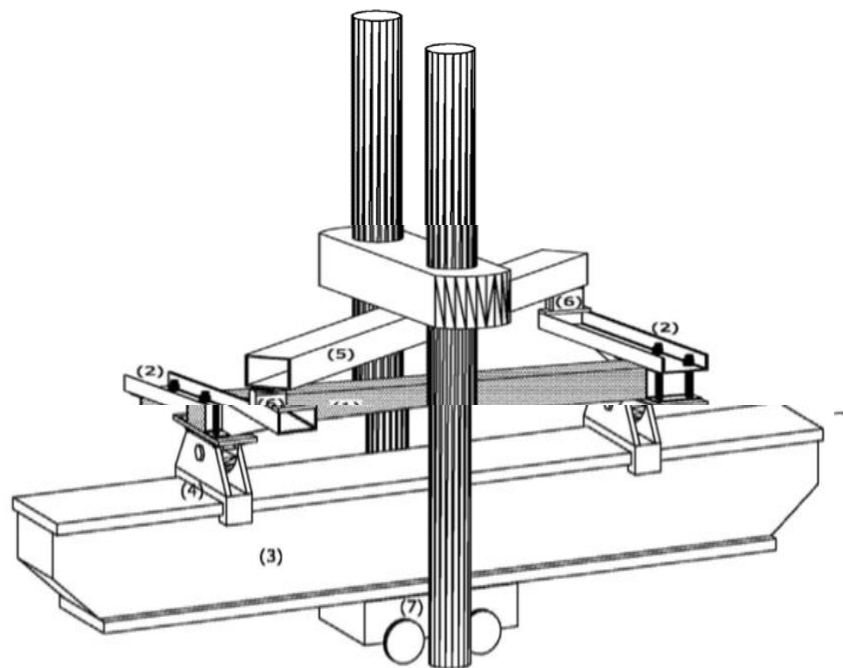

Fig. (5) clamping loading frame

The steel girder of (250 mm) depth and (2500 mm) long was used to transmit the loads from the center of the universal machine to the two arms (pure torsion). This girder was clamped to the universal machine as shown in Figure (6), the idea of this loading arrangement was mentioned by Zararis and Penelis ^[5]. All beams were tested under monotonically

increasing torque up to failure, the load was applied gradually. For each (5 kN) load increment, readings were acquired manually. The torque was increased gradually up to failure of the beam; Figure (6) shows test setup.



Figure (6): Arrangement of Beam Testing

3.6. Measuring Instruments

3.6.1. Angle of Twist Measurements

A simple method was used to estimate the angle of twist by using two dial gages attached the bottom fiber of the end of beam at a point (35 mm) from the center of the longitudinal axis of the beam as shown in Figure (7). The two dial gages on the right and on the left recorded the uplift and down values to find the twist angle in radians.



Figure (7): Angle of Twist Measurement

3.6.2. Elongation Measurements

Two horizontal dial gages were fixed at the center of the beam ends to measure the axial displacement of the beam as shown in Figure (8)



Figure (8): Elongation Measurement

4. Results and Discussion

4.1. Effect of Bolts Spacing on Load Carrying Capacity

The load carrying capacity reflects the maximum torsional moment and represents the ultimate applied load on the tested beam, after that drop in machine reading appears with rapidly deformation on beam, which termed as failure. Figure (9) shows this value for the tested beams.

The general Test results show that the reinforced concrete beams strengthened with bolted steel plate gain an increase in torsional strength over that of the unplated beam (BN) depending on the spacing between bolts, where both the cracking and ultimate torque increased as the spacing between bolts decreased. The composite beams with bolts spacing (100mm) exhibited an increase in cracking and ultimate torques (150 %) and (178 %) respectively. More increment at both cracking and ultimate torques were recorded for the composite beams of (75mm) spacing between connectors (200 %) and (206 %) respectively. While the largest increment at cracking and ultimate torques were recorded for the composite beams of (50 mm) spacing between bolts (250%) and (278 %) respectively in comparison with reference beam (BN).

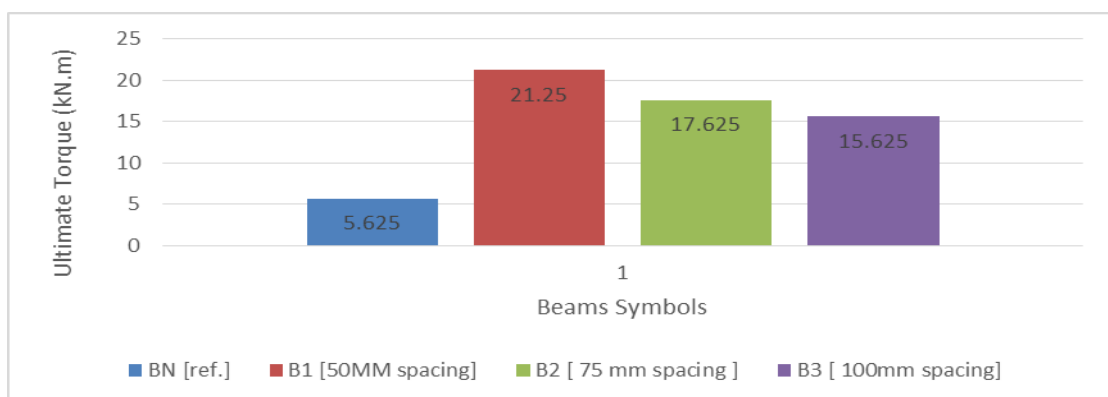

Figure (9): Load carrying capacity of the tested beams

4.2. Effect of Bolts Spacing on Angle of Twist

The torque twist response of the tested composite beams strengthened with steel plate connected with different bolts spacing (50, 75 and 100) mm was presented in figure (10). The experimental test results indicated that the spacing of shear connectors had a good contribution in improving the torsional resistance of the composite beams. Figure (10) indicates that there was a significant decreasing in angle of twist. Furthermore increment in both the area under the curve (stiffness) and the ductility of the composite beam as the spacing between bolts decreasing this behavior due to the increasing of number of shear connector as the spacing decreased, the increment in number of shear connectors provides more interaction between the composed materials which enhance the composite action between the reinforced concrete beam and the external steel plates.

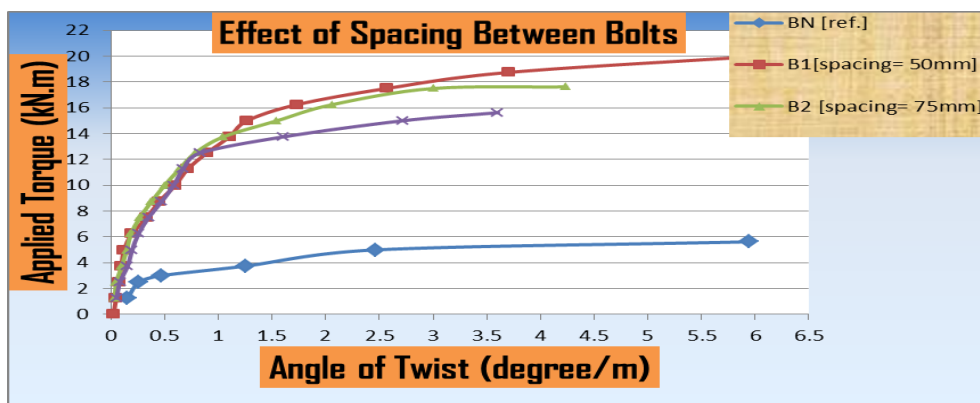

Figure (10): Torque–Twist Behavior of Composite Concrete-Steel Beams

4.3. Effect of Bolts Spacing on Longitudinal Elongation

Figure (11) explained the torque – longitudinal elongation relationship. From this figure it can be found that the bolts spacing had a significant contribution in decreasing the longitudinal elongation of composite beams, where the longitudinal strain of the composite beams decreased as the spacing decreased because of the increase in number of shear connectors which restrict the composite beam and constrain the diagonal cracks from widen.

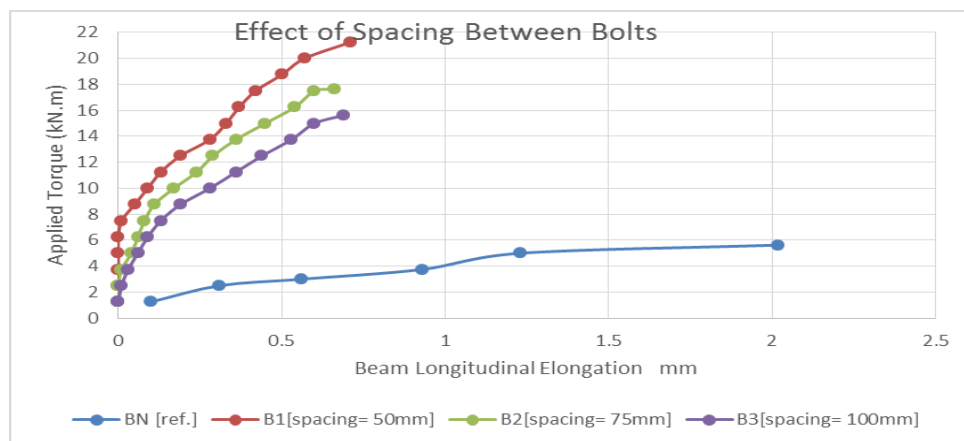

Figure (11): Torque– Longitudinal Elongation Behavior of Composite Concrete-Steel Beams

4.4. Modes of Failure

All the reinforced concrete beams were tested under pure torsion loading failed in torsion. Figures (12), (13), (14) and (15) show the modes of failure for the tested beams.



Figure (12): Failure of Reference (BN) Specimen



Figure (13): Crack Pattern and Failure Mode of composite beam (B1)



Figure (14): Crack Pattern and Failure Mode of Composite beam (B2)



Figure (15): Crack Pattern and Failure Composite beam (B3)

5. Conclusion

Based on the results obtained from the experimental work, the following conclusions are presented.

1. Using shear connectors to attach steel plates is successful and they are efficient in developing the composite action between the reinforced concrete beams and the external steel plates up to failure if they are properly designed in size and number to transfer the composite action.

2. The strengthening of reinforced concrete rectangular beams with steel plate under pure torsion increases the cracking load from (150 % to 250%) depending on the spacing between shear connectors.
3. The strengthening of reinforced concrete rectangular beams with steel plate under pure torsion increases the ultimate load from (178% to 278%) depending on the spacing between shear connectors.
4. Ductility and energy absorption capacity of the composite concrete-steel beams increase considerably when the bolts spacing decrease.
5. The global stiffness of the composite beams increase significantly as the spacing between shear connectors decrease.
6. Experimental results showed that the effect of the spacing between shear connectors working at all loading stages but in different ratios. At the plastic stage the effect of bolts spacing more than its effect in the elastic stage.
7. It was shown that as the spacing between shear connectors decreases from (100mm) to (50mm) the angle of twist will decrease from (0.351°) to (0.196°) at the torsional moment of (7.5 kN.m).
8. It was shown that as the spacing between shear connectors decreases from (100mm) to (50mm) the longitudinal elongation will decrease from (0.69) to (0.37) at the torsional moment of (16.25kN.m).

6. References

1. Oehlers, D.J. and Bradford, M.A., 1999, "Elementary Behaviour of Composite Steel and Concrete Structural Members", Butterworth-Heinemann, First published, p.259 .
2. Ridha, T.A., April 2012 " Structural Behaviour Of Composite Beams With Web Opening Under Repeated Loading" , M. Sc. Thesis, Al-Mustansiriya University.
3. ACI 544.3 R-98 "Guide for Specifying, Proportioning, Mixing, Placing, and Finishing Steel Fiber Reinforced Concrete", PP. 1-8.
4. ACI Committee 318, 1995, "Building Code Requirements for Structural Concrete (ACI 318M-95) and Commentary (ACI 318RM-95)", American Concrete Institute, Farmington Hills, Michigan, 371 PP.
5. Zararis P. and Penelis G., 1986,"Reinforced concrete T-beams in torsion and bending", ACI Journal, No. 83-17, P.