



EFFECT OF PERFORATED AND SMOOTH FINS ON THERMAL PERFORMANCE OF A LATENT HEAT ENERGY SYSTEM

Maitham Jameel Zaidan^{1*}, Dr. Mohammed Hamed Alhamdo²

- 1) M.Sc. Student Mechanical Engineering Department, Mustansiriyah University, Baghdad, Iraq.
- 2) Prof., Mechanical Engineering Department, Mustansiriyah University, Baghdad, Iraq.

Received 10/10/2018

Accepted in revised form 25/11/2018

Published 1/11/2019

Abstract: This work includes design, manufacture and improvement of a Waste Heat Recovery System (WHRS) for thermal energy storage unit by using PCM technique. Paraffin wax produced by Al- Durra refinery (major Iraqi oil company) has been used as a phase change material for this purpose. The heat transfer enhancement has been investigated experimentally and numerically by using perforated and smooth copper strips which inserted within paraffin wax in the form of fins. These coppers fins were welded with copper pipes in which water is flow inside it during the discharge process. The effect of fins and perforated fins with three different size of diameters (2,3 and 4 mm), on the heat transfer of PCM during melting process has been investigated to selecting the optimum among them. The results obtained indicate that inserting copper strips mainly rises heat transfer by conduction inside PCM and decreases the time of melting by about, 16% due to high thermal conductivity of this strips and the smooth fins are more useful than perforated fins for improving the thermal properties of paraffin wax and the rate of heat transfer. It is also found that the increase in the diameter of the perforations led to decrease the thermal performance of the fins.

Keywords: PCM, paraffin, melting, fins

تأثير الزعانف المثقبة والملساء على الاداء الحراري في نظام طاقة حرارية كامنة

الخلاصة: يشمل هذا العمل تصميم وتصنيع وتحسين نظام استعادة الحرارة المفقودة (WHRS) لوحدة تخزين للطاقة الحرارية باستخدام طريقة المواد المتغيرة الطور PCM. تم استخدام شمع البارافين والمنتج من مصفاة الدورة (كبرى شركات النفط العراقية) كمادة متغيرة الطور. تم اجراء دراسة تجريبية وعددية لتحسين نقل الحرارة باستخدام اشربة نحاسية بدون تثقيب واخرى مثقبة وتم إدخالها داخل شمع البارافين على شكل زعانف وتم لحامها مع أنابيب النحاس التي تنقل الماء أثناء عملية التفريغ للطاقة الحرارية المخزونة داخل البرافين. لقد تم دراسة تأثير الزعانف والملساء المثقبة بثلاثة أقطار مختلفة (2، 3 و 4 ملم) على نقل الحرارة خلال عملية الاذابة لتحديد أفضل قطر للتقوب بين هذه الأقطار. تشير النتائج التي تم الحصول عليها إلى أن إدخال شرائط النحاس كزعانف يحسن بشكل ملحوظ نقل الحرارة بالتوصيل داخل PCM ويقلل زمن الذوبان بنسبة 16%. بسبب الموصلية الحرارية العالية لهذه الزعانف النحاسية وتشير النتائج أيضا إلى أن الزعانف الغير مثقبة أكثر فائدة من المثقبة لتحسين الخصائص الحرارية لشمع البارافين ومعدل نقل الحرارة. كما وجد أن الزيادة في قطر التقوب أدت إلى تقليل الأداء الحراري للنظام.

1. Introduction

Nowadays scientists, researchers and policy makers have focused on the employment of naturally available renewable resources because of the increase in global energy consumption. The massive increase in energy demand is mainly due to urbanization and rapid industrial growth which causes the reduction of fossil fuels. [1] [2]. By heating any material to a higher temperature, energy can be stored in it. There are two general types of heat storage in all materials, latent heat storage and sensible heat storage. [3] [4]. Thermal energy storage (TES) plays a main part in energy conservation and can be reduce gap time between energy demand and energy supply [5]. Sensible heat is the energy that is required to change the temperature as shown in equation 1 [6].

$$Q = m c_p \Delta T$$

(Error! No text of specified style in document.)

where: Q is the thermal energy, m is the mass of PCM , Cp is the specific heat of PCM at constant pressure and ΔT is the temperature difference[6].

Latent heat storage (LHS) is the energy storage based on the heat absorption or release. Equation (2), gives the storage capacity of (LHS). Because of the extra positive terms for Q, the (LHS) has a bigger storage potential[6].

$$Q = \int_{T_i}^{T_m} m c_p \Delta T + m a_m \Delta h_m + \int_{T_m}^{T_f} m C_p \Delta T \quad (1)$$

where: a_m is the fraction melted, Ti the initial temperature, Δh_m: is heat melting per unit mass, T_m: the melting temperature, Tf: the final temperature.

A perfect PCM should show a high thermal conductivity, a high latent heat of fusion and a suitable phase-transition temperature [7]. In this work, paraffin wax was used as PCM due to its efficient latent energy storage. There are many methods to enhance the rate of heat transfer in the (LHS) system. The technique of finned tubes is one effective and reliable of these methods[8] [9] [10] while the perforated fins is one of the enhancement method of heat transfer[11].

(Castell, et al.,) [12] studied the effect of using vertical external fins in PCM units to increase the heat transfer coefficient as natural convection in the water. Paraffin wax was used as phase change material with a solar unit. By experimental work natural convection heat transfer coefficients for (PCM) modules has been determined with two

different external vertical fin geometries. The results show the technical possible of external fins for heat storage systems using (PCM).

(A. Reyes, et al.,) [13] studied the effect of distribution and shape of aluminum foils gotten from waste materials inside paraffin wax, in terms of the solidification time and thermal conductivity. For the arrangements of vertical perforated foils and horizontal perforated disks. They found the thermal conductivity had been doubled when using the aluminum foils. They solved the equations of the solidification process numerically in (Matlab Software Program) by using Finite Volume Method (FVM). The relative error was <10 % between the simulated output air temperature and the experimental values.

The aim of current work is to design a Waste Heat Recovery System to benefit the waste energy leaving from condenser of an air conditioning unit. For this purpose, a pair of U- tube with longitudinal fins, (with and without circular perforations) will be tested. The effect of three different sizes of these perforation on heat transfer response shall be investigated experimentally and numerically.

2. Numerical Simulation

The simulation in this study were done using ANSYS FLUENT 17.2 software program. The model in this study is a cylindrical capsule (6 cm diameter, 30 cm long with thickness 1.5 mm) putted inside a well-insulated rectangular duct as shown in figure (1). The capsule contains paraffin wax at the initial temperature 25°C.

The assumptions of the model include:

- The PCM is incompressible, Newtonian, and laminar.
- Thermal properties of the wax are changed with the temperature.

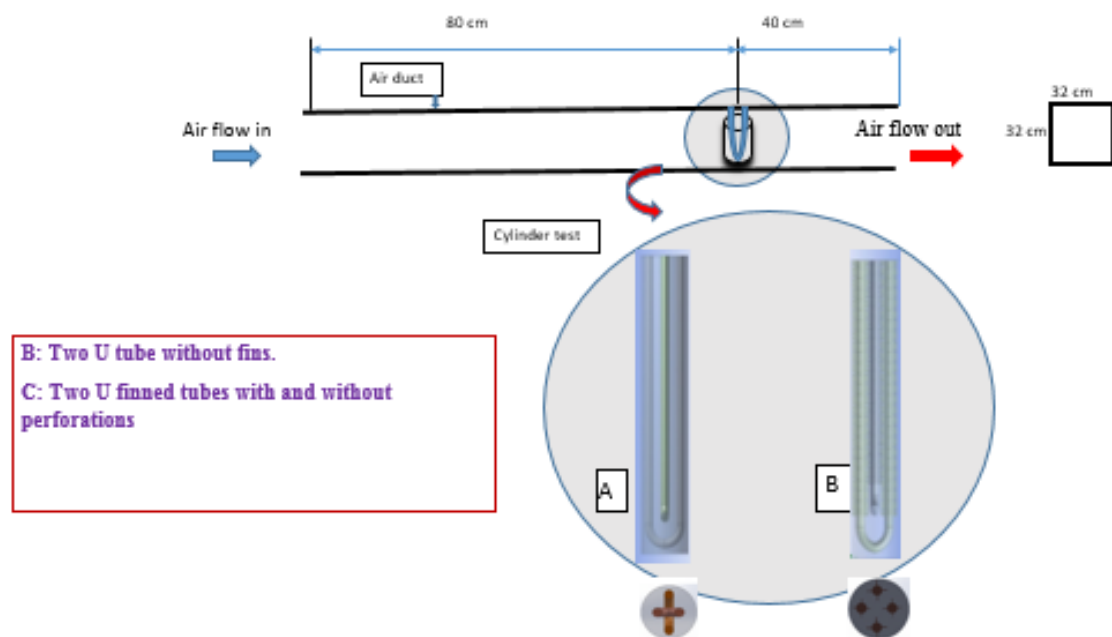

Figure (1) Physical symbol of the numerical model.

The thermal properties of PCMs, as density and viscosity are determined by correlations below.

$$\begin{aligned} \mu & \\ &= \exp\left(A + \frac{B}{T}\right) \end{aligned} \quad (3)$$

$$\rho = \frac{\rho_1}{(\beta(T - T_m) + 1)} \quad (4) \quad [14]$$

The governing equations are as follows.

The continuity equation:

$$\frac{\partial \rho}{\partial t} + \nabla \cdot (\rho \bar{U}) = 0 \quad (5)$$

The equation of Momentum:

$$\frac{\partial}{\partial t}(\rho \bar{U}) + \nabla \cdot (\rho \bar{U} \bar{U}) = -\nabla \cdot p + \rho \bar{g} + \nabla \bar{\tau} + \bar{F} \quad (6)$$

p is the static pressure, $\bar{\tau}$ is the stress tensor,

\bar{F} is external body forces

$\rho \bar{g}$ the gravitational body force and.

The energy equation:

$$\frac{\partial(\rho H)}{\partial t} \nabla \cdot (\rho \bar{U} H) = \nabla \cdot (K \nabla T) + S \quad (7)$$

T : the temperature, ρ is density, S : term of heat source, \bar{U} is the velocity. The total enthalpy H of the PCM is the sum of the latent heat, ΔH and the sensible enthalpy, h .

$$H = h + \Delta H \quad (8)$$

$$h = h_{ref.} + \int_{T_{ref}}^T C_p \Delta T \quad (9)$$

where: $h_{ref.}$ represent the reference enthalpy and T_{ref} : reference temperature, and the latent heat L of the paraffin wax as PCM, is written as:

$$\Delta H = \alpha L \quad (10)$$

α : the liquid fraction and is definite:

$$\alpha = \begin{cases} 0 & \text{if } T < T_{solid} \\ \frac{T - T_{solid}}{T_{liquid} - T_{solid}} & \text{if } T_{solid} < T < T_{liquid} \\ 1 & \text{if } T > T_{liquid} \end{cases} \quad (11)$$

The tool of generation the mesh which involved in the FLUENT workbench is used to create the mesh of this model, and this made after creating the geometry of the model. Since the model is 3D, two possible mesh elements can be used (quadrilateral and triangle) as shown in figure (2).



Figure (2) Mesh generation of the model

The second order upwind was utilized to solving the energy and momentum equations, whereas the pressure correction equation was adopted the PRESTO scheme [15].

3. Experimental work

The test rig was designed and manufactured locally as illustrated in Figure (3) and (4). A longitudinal fin with circular perforations of diameter (2, 3 and 4) mm were made in fins surface to test their effect on thermal performance inside PCM capsule. Figure (5), (6) and (7) show the details of the experimental tests.

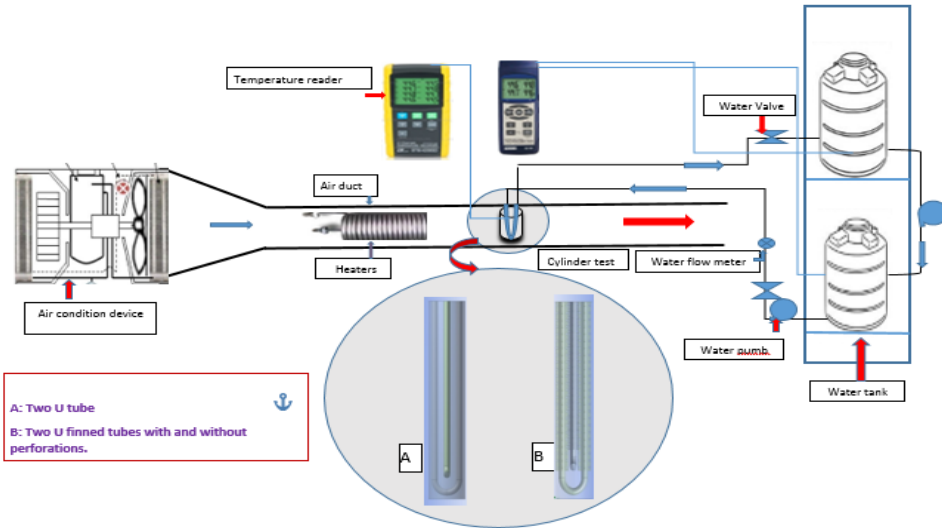

Figure (3) Schematic of the test rig

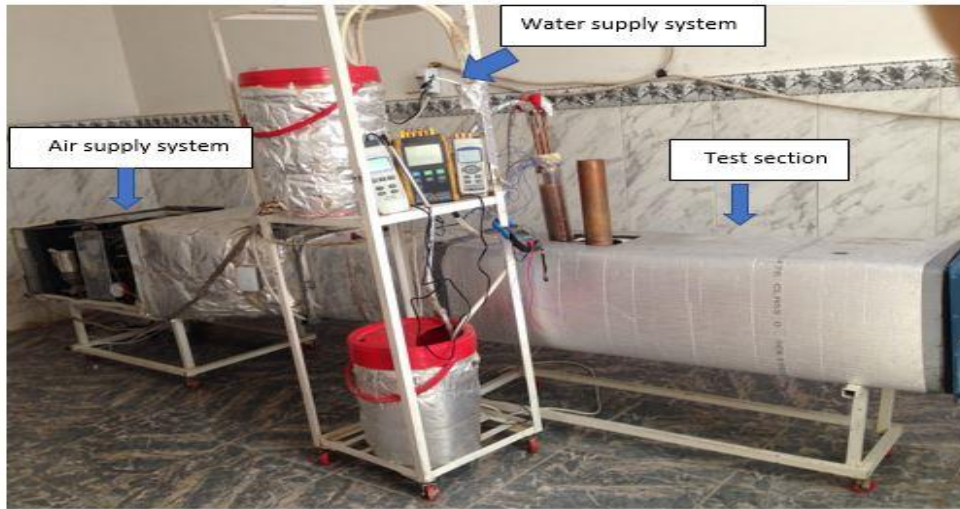

Figure Error! No text of specified style in document.) photograph of the test rig



Figure (5) Test section



Figure (6) Capsule with two copper U tube



Figure (7) Capsule with two copper U tube with perforated longitudinal fins

An air conditioner with 24,000 BTU / h has been used as source of waste hot air to the test section (HTF1). An additional auxiliary set of heaters (12000W) has been used inside the channel to ensure that the test section is supplied with hot air with a temperature of (75°C) at all time of charging (melting) process. To record paraffin wax temperatures, 9 thermocouples were inserted inside capsule as shown in Figure (8) .

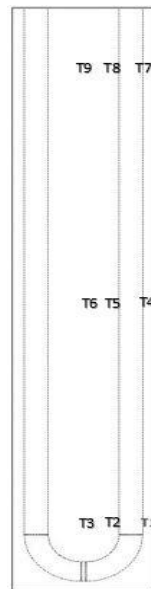

Figure (8) Thermocouples location inside PCM capsule

4. Results and Discussions

4.1 Melting process of PCM

Figure (9) shows the transient melting process inside PCM capsule. At the beginning of the charging, there are no changes of heat transfer because of the rate of conduction heat transfer not sufficient to do obvious variation in heat transfer, then the heat transfer change to the convection because of paraffin begins to melt. It seems that the viscosity effect is greatest at the convection process. The phase change starts in the outer cylinder wall surface and then inside PCM. Initially, the temperature of the PCM increases around its initial value until solidus point (the lower limits of the melting range). Then; the temperature of the paraffin wax (PCM) remains at near constant value around the melting temperature. After the temperature reaches to liquidus point, the material is totally melted, i.e. the phase was changed completely. Finally, the temperature of the paraffin wax (PCM) changes linearly again but at a lesser rate in a smaller temperature difference between the paraffin wax (PCM) and *HTF1*.

Figure (10) shows measured temperature distribution with time during charging (melting) process for nine points within PCM. Due to low thermal conductivity of paraffin wax, the upper plan had been stored more heating during charging process, so more time is needed to make heat travel downwards. This difference in temperatures of the different points inside PCM was minimized by adding copper strips as fins with dimensions of (200*6*1) mm for each water pipe because the thermal conductivity of PCM has been enhanced. Figure (10) shows that inserting copper strips mainly rises heat transfer by conduction inside PCM and decreases the time of melting by about, 16% due to high thermal conductivity of this strips.

The results showed that perforated fins have lower performance than smooth fins for improving the heat transfer in the melting processes of PCM. This may be due to the decrease in the total area of the fins, which is considered as key factor in the rate of heat transfer by conduction and convection. Moreover, it is detected that melting process in the lower part of capsule is imperfect (corresponding to the higher part) when not using fins. This result is referred to incomplete convection process as shown in figure (11).

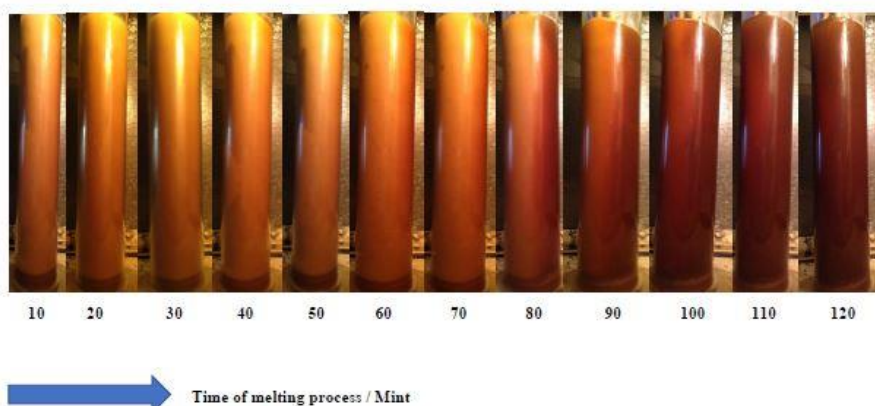

Figure (9) Time of melting during charging process

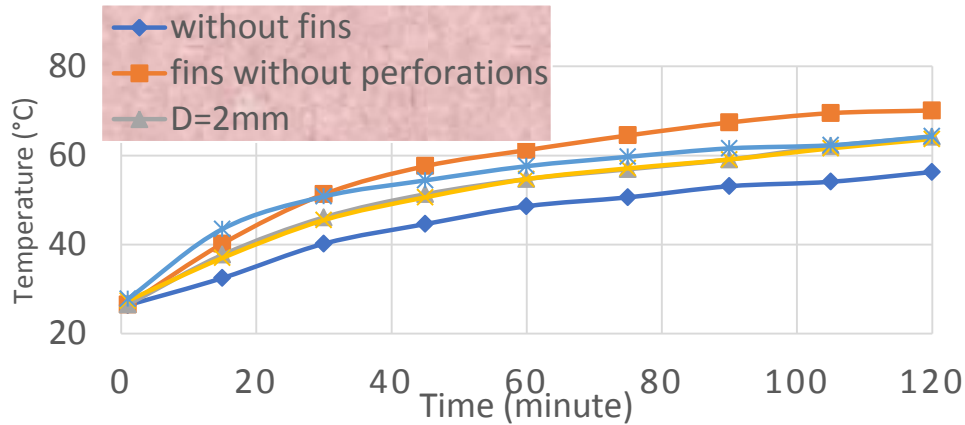

Figure (10) Variation of transient PCM temperature with and without perforated copper strips



Figure (11) melting process in the PCM capsule

4.2 Solidification Process of PCM

The solidification (or discharging) process is done using a cold water (HTF_2) that flows inside the copper pipes. The water is better than air in discharging process because of high specific heat [16]. However using of (PCM) for heating the water in a solar system had been investigated in many studies[12].

The solidification process within PCM is started directly after the melting process is completed and started around 60°C. The PCM in the capsule is in the liquid phase at the beginning of the solidification process, so the molten paraffin wax starts to solidify and releases heat as shown in Figure (12).

At the beginning, (during first 10 minutes), the temperature of paraffin was decreases suddenly, due to a high temperature variance between PCM and the cold water, then it will decrease slowly until reach to the equilibrium point between PCM and HTF_2 . The amount of enhancement on the solidification process by adding copper fins was decrease the solidification time by 9% as shown in figure (13).

However, with using circular perforation of three different diameters (2,3 and 4mm), the solidification time increase by (6,5,3%) respectively.

The solidification happens firstly at the top of the capsule then towards the bottom and takes more time to reach steady state. The amount of loss of heat at the top of the PCM capsule being more than the center and bottom of the capsule due to the cold water is entering from the top part of capsule which absorbs more amount of heat from molten PCM.

The second phenomenon about the solidification of molten paraffin, that the paraffin contacted with the pipes will solidify faster than the other inside the capsule because of the fast loss of wax heat to the cold water through the pipe as shown in figure (12). This is the main snag that preventing using all the heat in the molten paraffin, some of which were exceeded by placing fins to take advantage of the thermal energy in the melting paraffin wax distanced from the tube. Then, the temperature reaches steady state very quickly, after complete solidification. Its noted that the whole required melting time is leaser than the solidification time because the high specific heat of water.

The enhancement in heat transfer from wax to water through finned tubes is due to the increase of the contact surface area between them. The percentage of enhancement rate at 1, 15 and 30 minutes are found to be 5.2%, 8.5% and 9.4% respectively, while adding perforations in the fins do not help to improve the rate of heat transfer, since it was observed that the increase in the diameter of the circular perforations led to decrease in thermal effect of the fins as shown in figure (14).

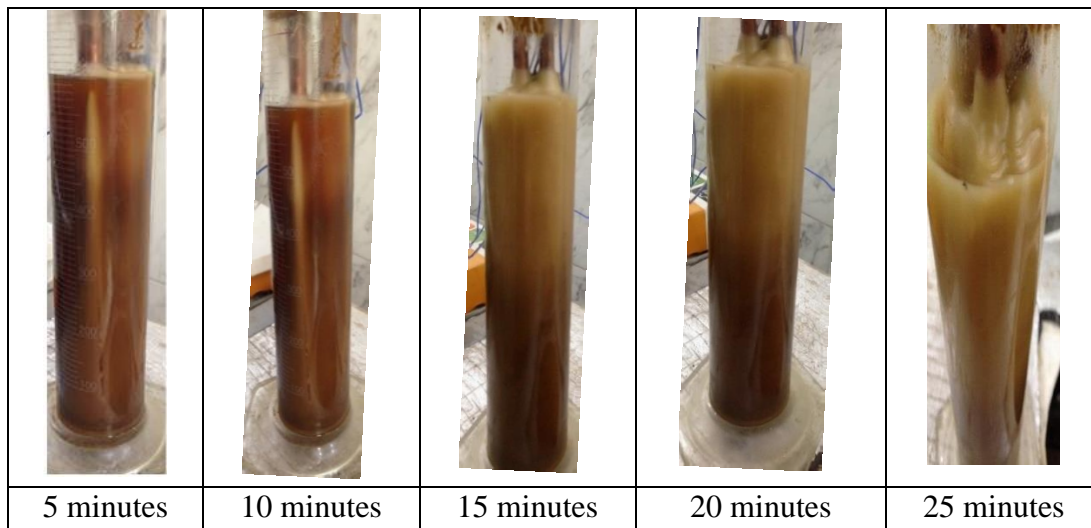

Figure (12) The process of solidification in PCM

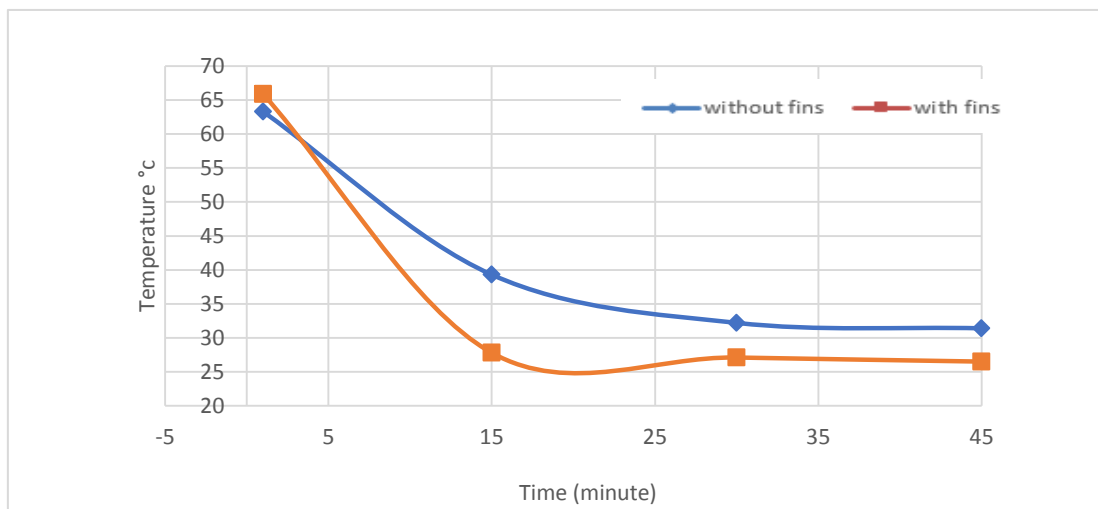

Figure (13) Effect of copper strips on solidification process inside paraffin wax

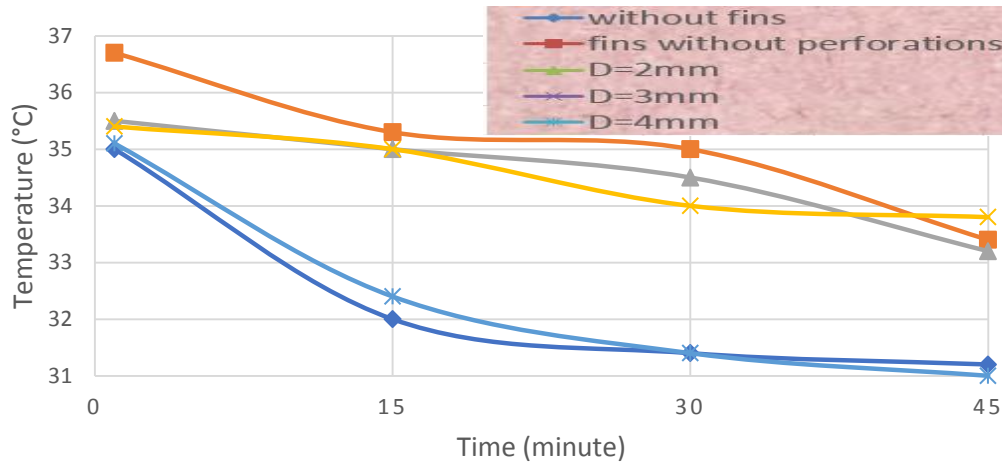

Figure (14) The temperature of HTF2 Comparison between the processes of discharge PCM with circular perforated fins and without fins

5. Statistical Analysis of the Results.

The statistical software, Design-Expert V10.0.7 have been used to the experimental results by using Surface Response Methodology (SRM). Several studies and research have adopted this type of statistical analysis in the analysis of results [17]. This model for the temperature distribution, shown in tables (1).

Table (1) Design Summary

Factor	Name	Units	Minimum	Maximum	Mean	Standard Deviation
B	Diameter of perforation	mm	0.00	4.00	2.25	1.50
Response	Temp.	°C	26.50	70.10	52.93	12.44

Figure (15) shows the actual results which spread along the predicted line which represents a slope line.

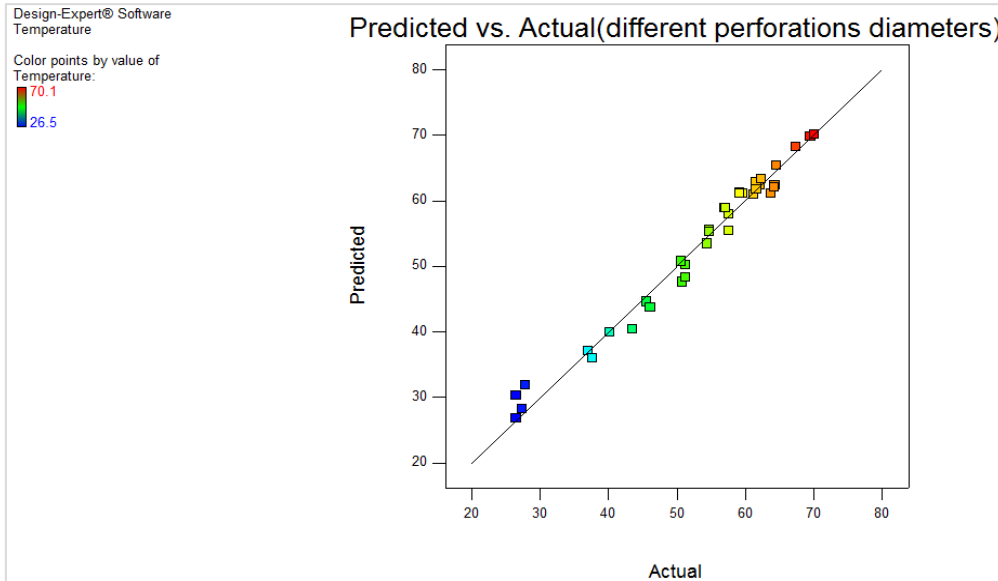

Figure Error! No text of specified style in document. .Actual versus predicted temperature values.

Figures (16) and (17) showed the effect of both factors (time and diameter of perforation) at the same time on the temperature with the constancy of the other factors. The design points shown as a red sphere on these figures. This test gives predicted values very near to actual values and can be used to predict the temperature within specified levels of the other factors.

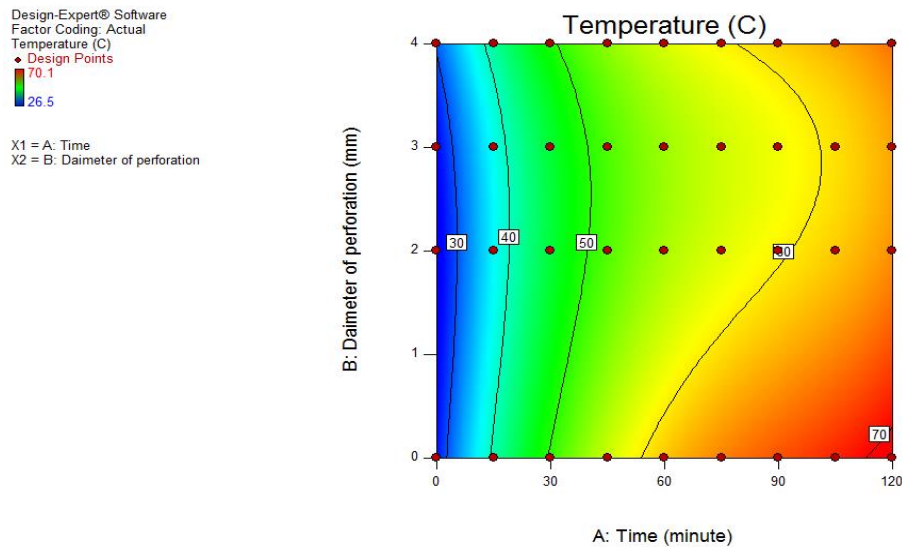

Figure (16) Time and daimeter of perforation contour showing the interactive effect on the temperature at constant other factors

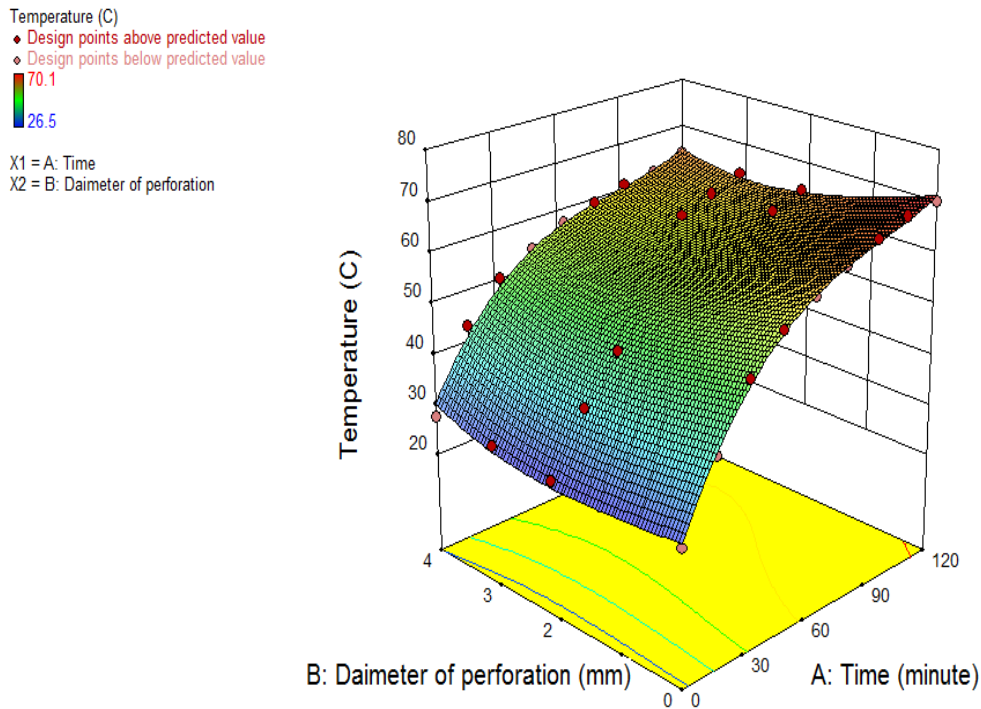

Figure (17) view of the interactive effect of time and daimeter of perforaition on the temperature at constant other factors

6. Comparison Between the Numerical and Experimental Results

Practical experiments and theoretical simulations have been compared as shown in figure (18). The results show that there was an acceptable approximation between experimental and theoretical results.

The percent of difference between the experimental and numerical data for melting processes was less than 10%. The difference between both results (numerical and experimental) might be because of some assumptions have been assumed in the ANSYS FLUENT program software.

This include thermal and physical properties of the paraffin wax to simplify the solution also the location of the thermocouples inside the PCM may be changed during the solidification or melting of process.

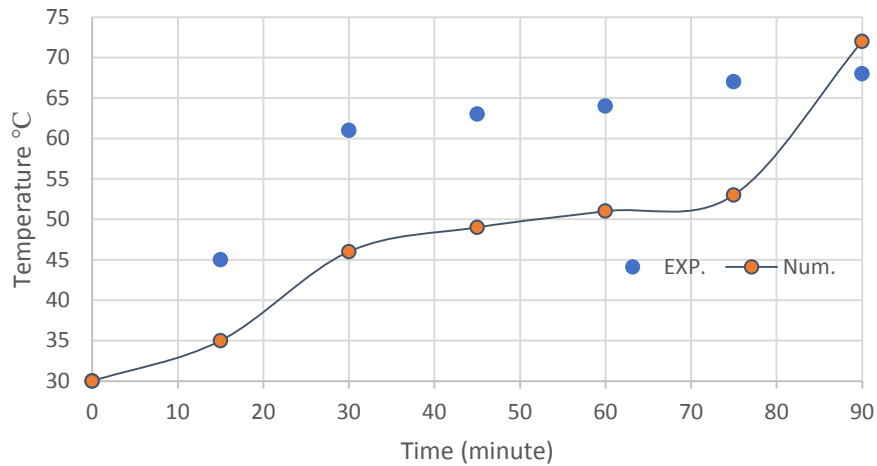

Figure (18) Comparison between experimental and numerical results for 2UTPF system during melting process.

7. Numerical Results

The simulation in this study were done using ANSYS FLUENT 17.2 software program. Figures (19) to (22) display the temperature distribution inside PCM during discharging and charging process.

It is clear from results that at the beginning of this process the wax melts near the wall and gradually continues to melt towards the center of the capsule until the melting process is fully completed.

The PCM temperature contours are nonuniform during charging process due to the difference in density and wax low thermal conductivity. The melting process occurred early nearby wall of the capsule then formed layers of molten wax. The molten part of paraffin wax is pushed to the upper of the test capsule because of the convection and buoyancy, on the other hand, the solid part of the paraffin wax is pushed down because of the various densities of the wax at the solid state and liquid state. Adding the fins to the pipes is found to increase the rate of heat transfer.

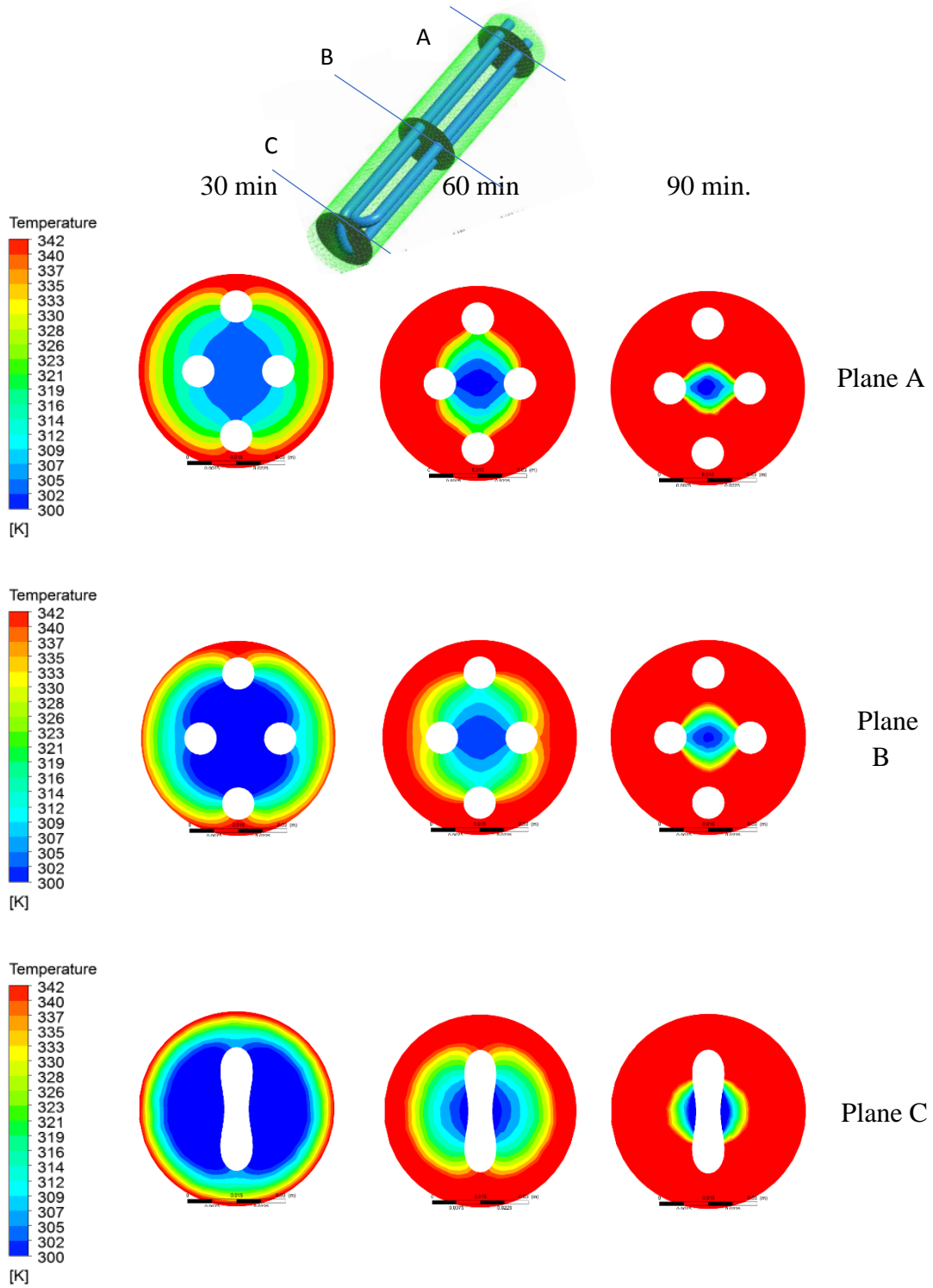
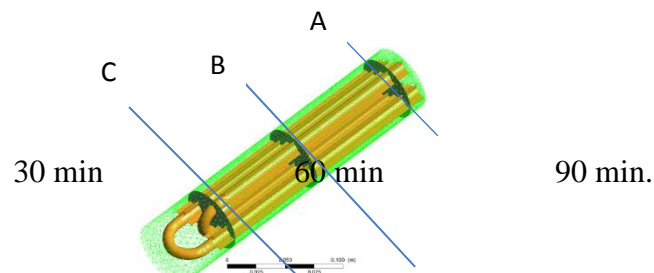

Figure (19) Temperature contours inside PCM during charging process through 2UTWF.



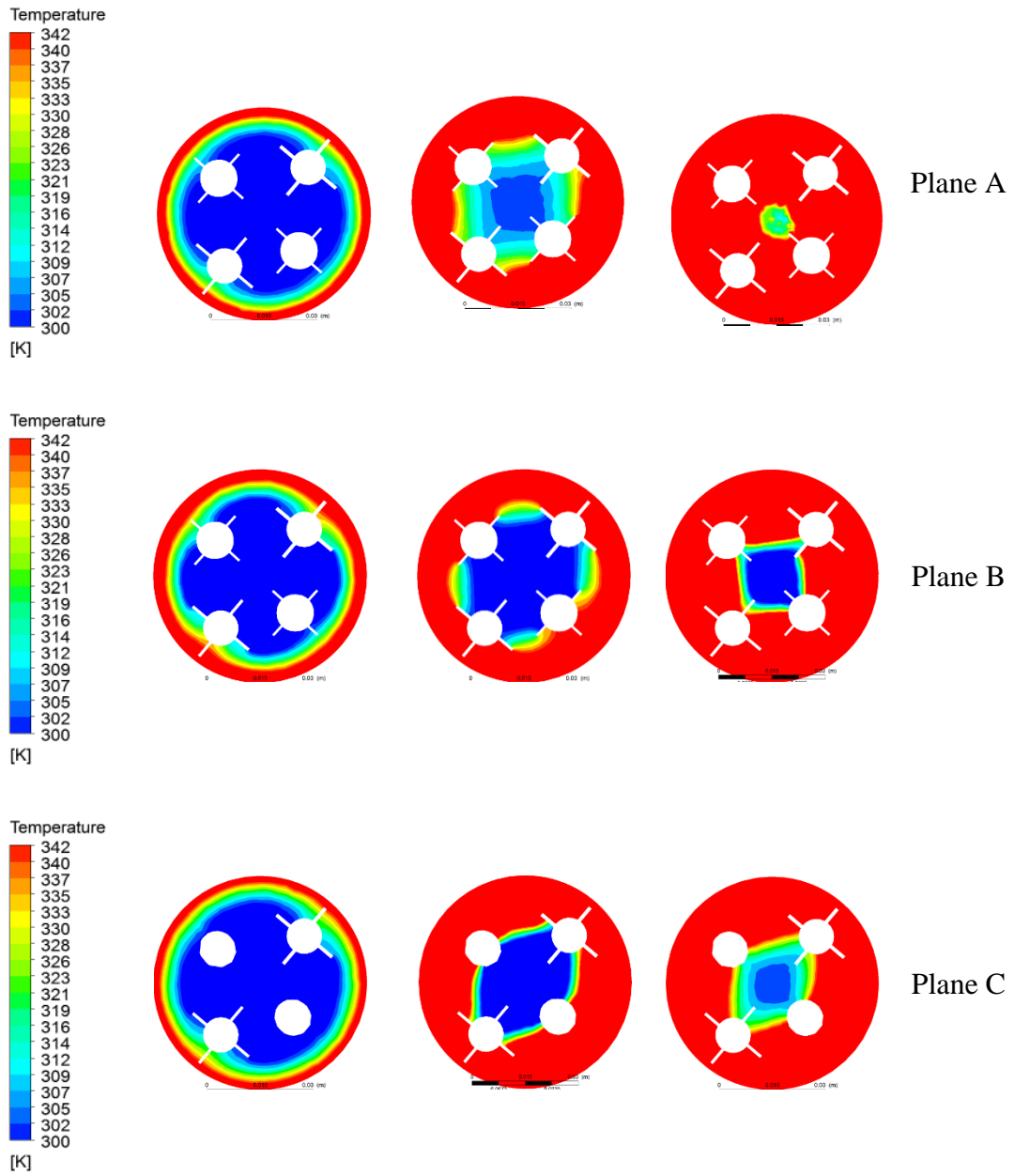
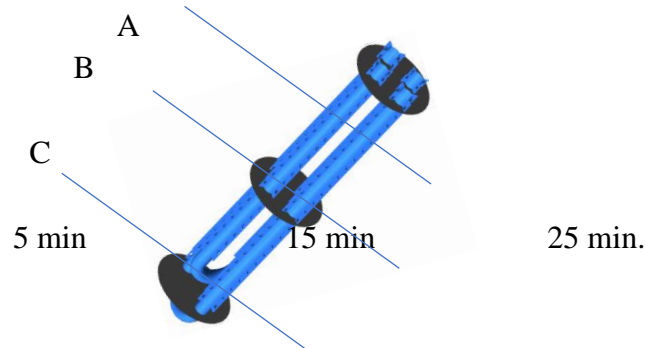

Figure (20) Temperature contours inside PCM during charging process through 2UTPF



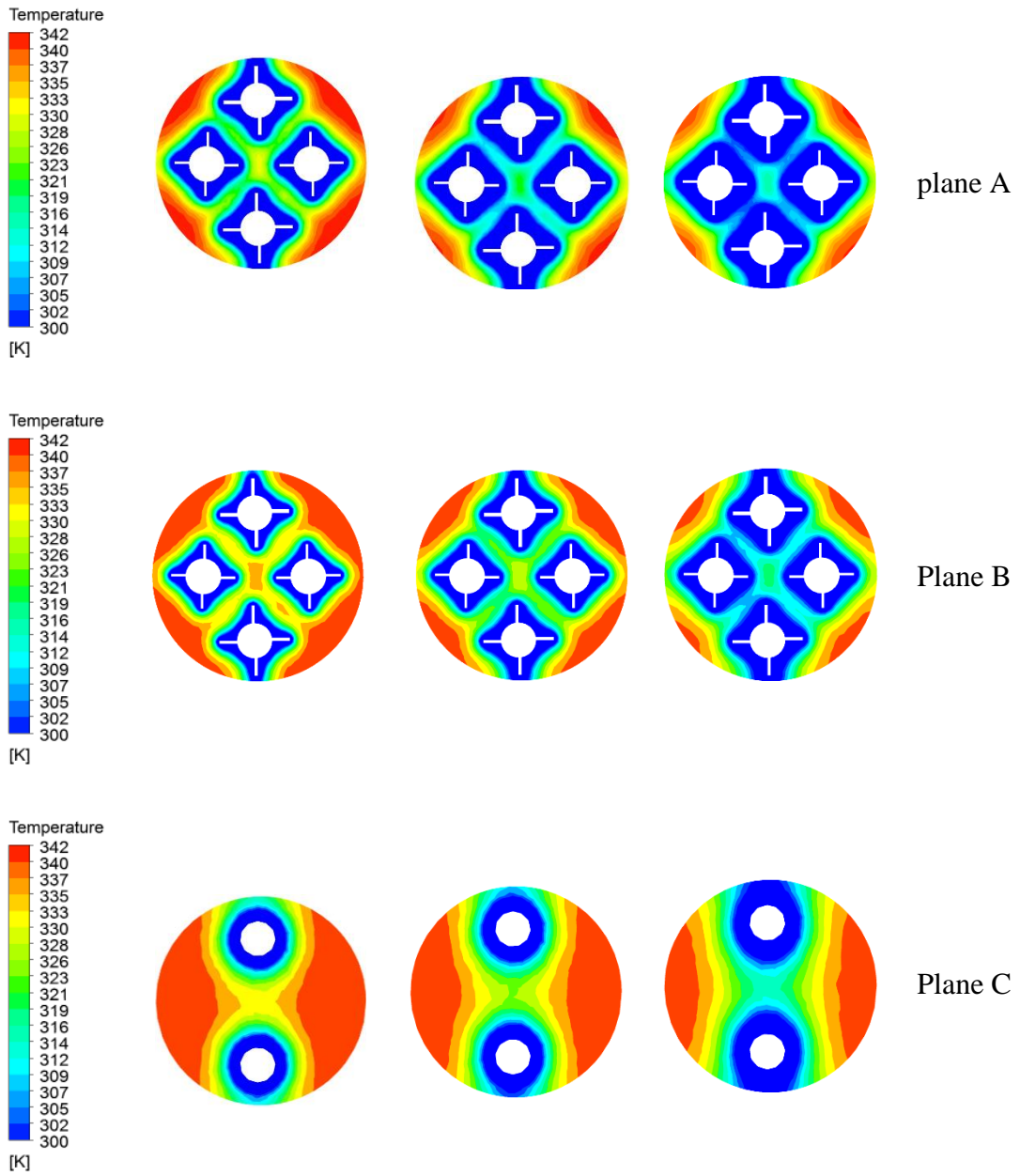
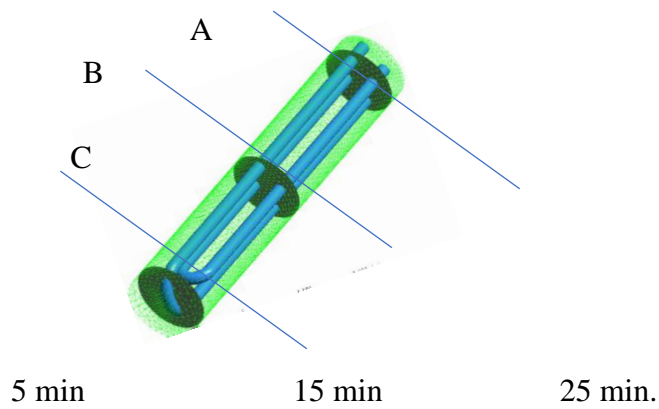

Figure (21) Temperature contours inside PCM during discharging process through 2UTPF



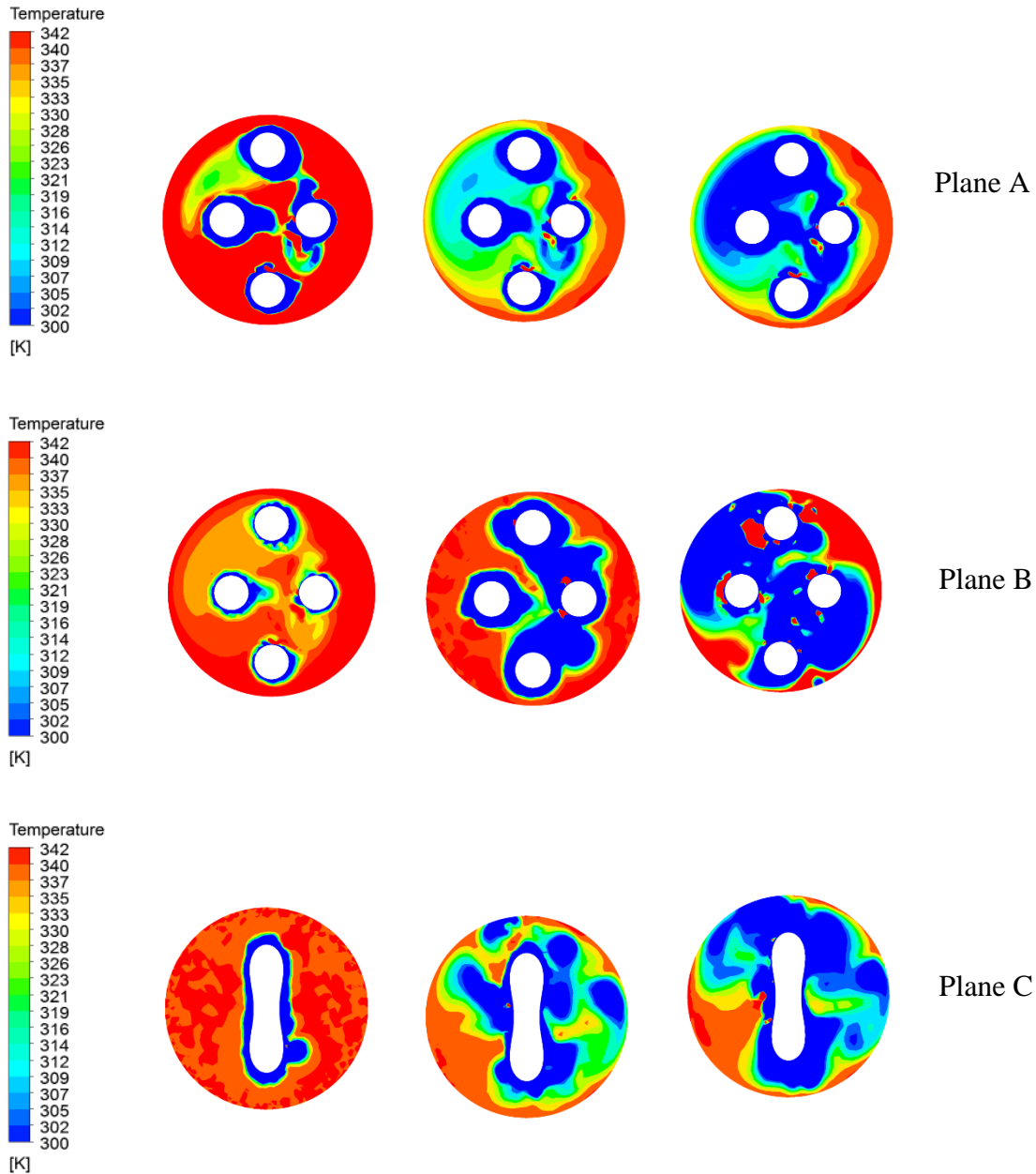

Figure (22) Temperature contours inside PCM during discharging process through 2UTWF

8. Conclusions

Based on the findings of this work, the conclusions below were drawn:

- 1- Inserting copper strips mainly rises heat transfer by conduction inside PCM and decreases the time of melting by about, 16% due to high thermal conductivity of this strips. The amount of enhancement on the solidification process by adding copper fins has been found to decrease the solidification time by 9%
- 2- The melting process in the lower part of capsule is imperfect (corresponding to the higher part) when not using fins.

- 3- The results showed that perforated fins have lower performance than smooth fins for improving the heat transfer. Also, it was observed that the increase in the diameter of the circular perforations led to decrease in thermal effect of the fins.

9. References

1. S. Lokesh, P. Murugan, A. Sathishkumar, V. Kumaresan, and R. Velraj, (2015) "Melting / solidification characteristics of paraffin based nanocomposite for thermal energy storage applications," *Therm. Sci.*, vol., pp. 1–11, 2015.
2. N. H. S. Tay, F. Bruno, M. Belusko, A. Castell, and L. F. Cabeza,(2012) "Experimental validation of a CFD model on a Vertical Finned Tube Heat Exchanger Phase Change Thermal Energy Storage System," *innostock 2012 12th Int. Conf. Energy Storage*, pp. 1–9,
3. E. W. Gabisa and A. Aman, (2016) "Characterization and Experimental Investigation of $\text{NaNO}_3 : \text{KNO}_3$ as Solar Thermal Energy Storage for Potential Cooking Application," vol. 2016,
4. A. M. Abdulateef, S. Mat, J. Abdulateef, K. Sopian, and A. A. Al-abidi,(2017) "Geometric and design parameters of fins employed for enhancing thermal energy storage systems : a review," *Renew. Sustain. Energy Rev.*, no. June 2016, pp. 1–16,
5. P. Patil and T. Dey, (2016) "Experimental Study of Latent Heat Thermal Energy Storage System using PCM with Effect of Metal Configurations and Nano particles," vol. 5, no. 5, pp. 236–240,
6. J. Henriksson, (2016) "Comparative simulation of heat transfer in a cylinder of phase changing material,"
7. L. Colla *et al.*, (2015) "Nano-PCMs for passive electronic cooling applications," vol. c, no. January 2016, pp. 1–10,
8. R. Velraj, R. V. Seeniraj, B. Hafner, C. Faber, and K. Schwarzer, (1997) "Experimental analysis and numerical modelling of inward solidification on a finned vertical tube for a latent heat storage unit," *Sol. Energy*, vol. 60, no. 5, pp. 281–290,
9. K. A. R. Ismail, C. L. F. Alves, and M. S. Modesto, (2001) "Numerical and experimental study on the solidification of PCM around a vertical axially finned isothermal cylinder," *Appl. Therm. Eng.*, vol. 21, no. 1, pp. 53–77,
10. S. Karthikeyan, G. Ravikumar Solomon, V. Kumaresan, and R. Velraj,(2014) "Parametric studies on packed bed storage unit filled with PCM encapsulated spherical containers for low temperature solar air heating applications," *Energy Convers. Manag.*,
11. H. Shokuhmand, F. Sangtarash, and P. Student, (2013) "The effect of dimple and perforations on Flow Efficiency and heat transfer enhancement in Multi louvered Fin banks," *Life Sci. J.*, vol. 10, no. 9, pp. 30–40,
12. A. Castell, M. Medrano, J. Roca, L. F. Cabeza, and U. De Lleida, (2002) "Use of External Vertical Fins in Phase Change Materials Modules for Domestic Hot Water Tanks," vol. 1, no. 4, pp. 1–9,
13. A. Reyes, L. Henríquez-Vargas, J. Rivera, and F. Sepúlveda, (2017) "Theoretical and experimental study of aluminum foils and paraffin wax mixtures as thermal

-
- energy storage material,*” *Renew. Energy*, vol. 101, pp. 225–235,
14. R. Kandasamy, X. Q. Wang, and A. S. Mujumdar, (2008) “Transient cooling of electronics using phase change material (PCM)-based heat sinks,” *Appl. Therm. Eng.*, vol. 28, no. 8–9, pp. 1047–1057,
 15. S. Patankar, “*Numerical heat transfer and fluid flow, 1980*” *Series in computational methods in mechanics and thermal sciences*. pp. 1–197,.
 16. D. Zhao and G. Tan, (2015) “Numerical analysis of a shell-and-tube latent heat storage unit with fins for air-conditioning application,” *Appl. Energy*, vol. 138, pp. 381–392,
 17. V. Khalajzadeh, G. Heidarinejad, and J. Srebric, (2011) “*Parameters optimization of a vertical ground heat exchanger based on response surface methodology,*” *Energy Build.*, vol. 43, no. 6, pp. 1288–1294,.