

Electromagnetic Wave Detector

*MSc. Ibrahim Amer Ibrahim
Biomedical Engineering Department
Al-Khwarizmi College of engineering/ Baghdad University
E-mail: iai.power@gmail.com
Mobile: 07901979656*

Abstract

The aim of this study or paper is to design and implement a system or device (an electronic circuit) for testing, discovering (detect) and measuring the electromagnetic field intensity (EMF) in the local area (in our environments), caused by the microwaves product from cellars mobiles or other devices.

A design was built and tested theoretically and implemented practically then tested and the results were discussed and putted in tables and curves. The tests show how the dangers of EMFs are near to us and it is real and can effect on the human health according to the incurably increasing by the numbers of cellars mobiles and communications applications. The study shown that if we use the mobile cellar phone for 10 hours continuously, we be very close to the danger limits of the EMFs on human.

Finally, the test shows the different between the cellars mobiles and the calling methods in the averages received power.

الخلاصة

أن الهدف من هذا البحث أو الدراسة هو لتصميم وتنفيذ منظومة أو جهاز (دائرة إلكترونية) لفحص , اكتشاف وقياس شدة المجال الكهرومغناطيسي في المناطق المحيطة بنا (في محيطنا) المتسببة بواسطة الموجات المتناهية الصغر الصادرة عن الهواتف الخلوية و المصادر الأخرى للموجات.

وضع تصميم للدائرة وفحص نظريا ونفذ عمليا وبعد ذلك أجريت التجارب وسجلت النتائج و نوقشت ووضعت في جداول ومنحنيات. أثبت الفحص أن مخاطر المجال الكهرومغناطيسي قريبة منا وحقائقية نظرا للزيادة الهائلة لأجهزة و تطبيقات الاتصالات. أظهرت الدراسة عند استخدام الهاتف النقال لمدة تزيد عن العشر ساعات نكون جدا قريبين من الحدود الخطرة للمجال الكهرومغناطيسي على الإنسان. وأخيرا أظهرت النتائج الأختلافات بين أنواع الهواتف وطرق الأتصال من حيث القدرة المستلمة.

1-Introduction:

EMF surrounds anything that use or carries electricity, so the possible risks of radio-frequency electromagnetic fields (EMF) (especially the microwaves from hand-held mobile phones) for the human body is a growing concern. [1]

The EMF is always strongest near the source and diminishes as you move away from the source. The energies have the ability to influence particles at great distances.

The possible risks of EMF microwaves for the human body has attached interest since the 1960s [2] before the advent of mobile phones, when radar and microwave ovens posed a possible health problem.

The effects of EMF on biological tissue remains the most controversial aspect of the EMF issue with virtually all scientists agreeing that more research is necessary to determine safe or dangerous levels. Iron, necessary for healthy blood and stored in the brain, is highly effect by EMF. The permeability of the cell membrane of our nerves, blood vessels, skin, and other organs is affected. The intricate DNA of the chromosomes has been shown to be effected by EMF's as well. In fact, throughout our bodies, every biochemical process involves precisely choreographed movement of EMF-sensitive atoms, molecules, and ions. [3, 4, 5]

The levels we are commonly exposed to be usually between 0.1 and 4 milligauss [3]. A 2.5 mG or the ranges (2 μ Tesla - 4 μ Tesla) are the generally accepted limit of magnetic field exposure. [3]

Also, in the power density notation, an electric field well generates electric power densities. This power density may be causes a serious problem in human health if it's in the ranges of (0.24 – 2.4) W/m² or more [2].

The International Commission on Non-Ionizing Radiation Protection (ICNIRP) – was chartered by the International Radiation Protection Association (IRPA)

As the successor to the International Non-Ionizing Radiation Committee INIRC. In 1994 ICNIRP issued guidelines covering static magnetic fields, and followed these, in 1998, by guidelines covering the frequency range for time-varying non-ionizing electromagnetic fields up to 300 GHz.

The exposure guidelines for mobile devices employ a unit of measurement known as the Specific Absorption Rate or SAR. ICNIRP has advised that this should not exceed 2W/Kg (Watts per Kilogram), for the frequency range (10MHz-10GHz). Whole- body average SAR (W/kg) is (0.08). [6, 7]

A recent in vitro study has shown that EMF at 1.8 GHz increase the permeability of the EMF microwaves risk on brain and also the 0.9 GHz frequency can case the same risk if expose to the EMF was continues for along time [2,5].

2-Theoretical background:

Electromagnetic field (EMF): its lines of force of electric field and magnetic field, electric and magnetic fields surround anything that use or carries electricity. [7, 8]

The EMF is a general term which includes electric fields generated by charged particles; magnetic fields generated by charged particles in motion, and radiated fields such as TV, radio, microwaves. Electric fields are measured in units of volts per meter or V/m. Magnetic fields are measured in milli-Gauss or mG. [2] Where appropriate, the reference levels have been obtained from the basic restrictions by mathematical modeling and by extrapolation from the results of laboratory investigations at specific frequencies. They are given for the conditions of maximum coupling of the field to the exposed person, thereby providing maximum protection. The reference levels are intended to be spatially averaged values over the entire body of the exposed person, but with the important proviso that the basic restrictions on localized exposure not be exceeded.

Protection against established adverse health effects of RF exposure requires that the relevant basic restrictions not be exceeded. However, of the basic restriction quantities, only power density in air can be readily measured for an exposed person. The reference levels, on the other hand, can be measured readily in a practical exposure situation, and can therefore be used to determine whether the corresponding basic restriction is likely to be exceeded. The rule is that compliance with the reference level will always ensure compliance with the corresponding basic restriction. If a calculated or measured value exceeds the relevant reference level, it does not necessarily follow that the corresponding basic restriction will be exceeded. What is then required, is a detailed analysis to assess compliance with that particular basic restriction, and this will invariably involve the application of sophisticated calculation techniques.

If such calculations indicate that the basic restriction is indeed being exceeded, protective measures will have to be instituted to rectify the situation. The Department of Health is not prescriptive as to the kind of measures that must be instituted. The Department maintains the firm opinion that whoever manages/runs an installation, which purposely produces EMF, is best suited to making these kinds of decisions. In all instances the requirement remains the same, i.e. adequate measures must be instituted to prevent any person from being exposed in excess of the basic restrictions. For the purpose of demonstrating compliance with the basic restrictions, the reference levels for the electric and magnetic fields should be considered separately and not additively. This is because, for protection purposes, the currents induced by electric and magnetic fields are not additive. [6, 7] For a conservative approximation, field exposure levels can be used for near-field assessment since the coupling of energy from the electric or magnetic field contribution cannot exceed the SAR restrictions. For a less conservative assessment, basic restrictions on the whole-body average and the local SAR should be used.

The term "average power" is very popular and it's used in specifying almost all RF and microwave systems.

(dBm) is used as a measure absolute average power, $\text{dBm} = 10 \log_{10} \{P/1\text{mW}\}$ (1)

3- Experiment and Work:

A simple circuit was connected to use here and implemented experimentally and tested, the Radio Frequency (RF) detector her was based on the linear integrated circuit (TLC 5508) [9,10]. This linear integrated circuit can convert the Rf received power to a direct voltage (D.C.) proportional to the input RF power. To do that, it must integrate several functions to provide RF power detection over frequencies ranging from 300MHz to 7GHz.

These functions include an internally compensated buffer amplifier, an RF Schottky diode peak detector and level shift amplifier to convert the RF input signal to DC, a delay circuit to avoid voltage transients at VOUT when coming out of shutdown and a gain compression circuit to extend the detector dynamic range. Buffer Amplifier, The buffer amplifier has a gain of two and is capable of driving a 2mA load. The buffer amplifier typically has an output voltage range of 0.25V to 1.75V. The internal RF Schottky diode peak detector and level shift amplifier converts the RF input signal to a low frequency signal. The detector demonstrates excellent efficiency and linearity over a wide range of input power. The received antenna used here was the log periodic antenna (LPA) to receive signals with frequency of (500MHz - 2GHz). The schematic of the (LPA) shown in figure (1) below.

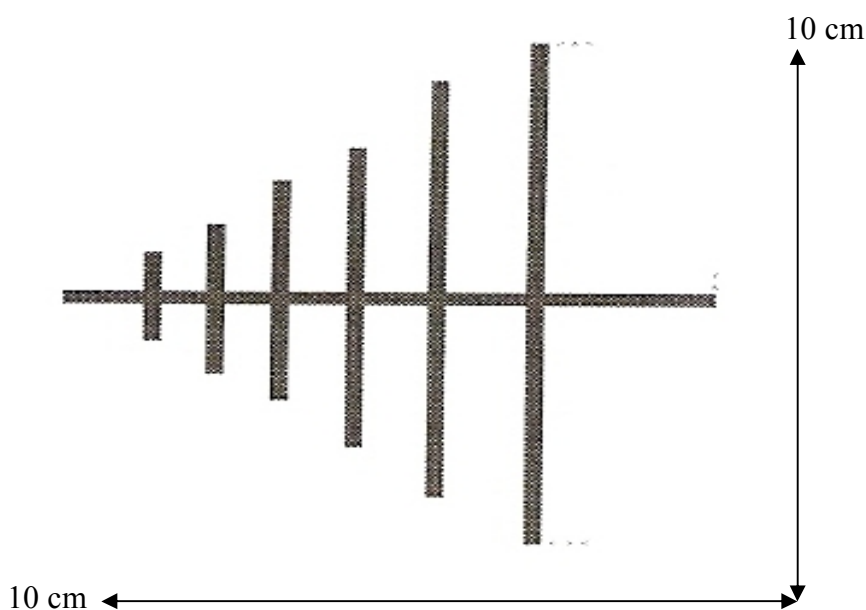

Figure (1) LPA antenna

This antenna made with copper wire fixed on a printed card bored (PCB) and its end (the long wire end) was connected to a good SMA connector with a small pin. And by a matching transformer we match the impedances of the antenna output impedance (75Ω) and the electronic input impedance (150Ω) in order prevent reflection of signals between them. The circuit needs a quality microwave ATC capacitor in the input of the RF detector integrated circuit (TLC5508) and with a digital voltmeter connected to the output to give the D.C. out voltage readings. See the block diagram in figure (2). The wiring schematic is shown in figure (3).

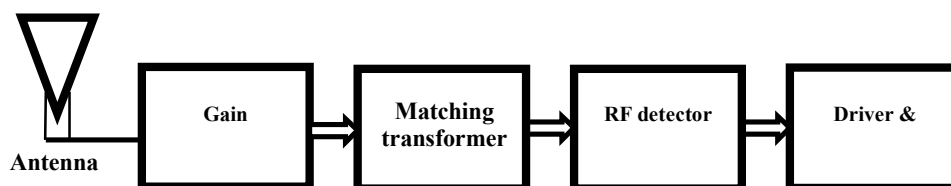

Figure (2) The block diagram of the circuit

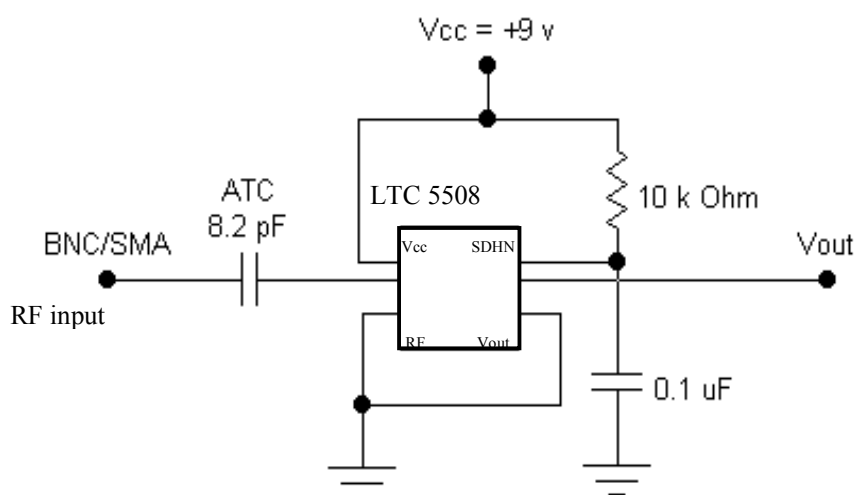

Figure (3) The wiring diagram of the circuit

Since, the RF detector integrated circuit (TLC5508) was a linear integrated circuit in which the RF power was directly linear proportional to the out put direct voltages (D.C) in the range of RF power ($-20 - 10$) dBm. So. It very easy to find a first order equation between the RF input power and an out put (D.C) voltage, as follow:

By taking two measurements with a functions generator (pulse function) connected to the BNC of the circuit to give a RF power as example of frequency (1GHz).

- 1- With an input power of (-4) dBm, the output of the digital voltmeter (VDM) read a D.C voltage of (0.7) v.
- 2- With an input power of (6) dBm, the output of the digital voltmeter (VDM) read a D.C voltage of (1) v.

The equation is of the form:

$$P \text{ (dBm)} = A + B \times V_{(VDM)} \dots\dots\dots(2)$$

We use the data above to form two equations with two unknowns:

$$P_1 = A + B \times V_1 \dots\dots\dots(3)$$

$$P_2 = A + B \times V_2 \dots\dots\dots(4)$$

$$P_1 = - 4 , V_1 = 0.7$$

$$P_2 = 6 , V_2 = 1$$

We subtract Eq.3 from Eq.4 to get:

$$(P_1 - P_2) = B \times (V_1 - V_2) \text{ resulting to}$$

$$B = (P_1 - P_2) / (V_1 - V_2) \dots\dots\dots(5)$$

And than insert the B in Eq.3 we gotten:

$$P_1 = A + [(P_1 - P_2) / (V_1 - V_2)] \times V_1 \text{ and solve this for A to get:}$$

$$A = P_1 - [(P_1 - P_2) / (V_1 - V_2)] \times V_1 \dots\dots\dots(6)$$

We putted the P and V values from above into the equations (6, 5) for the final results:

$$P(\text{dBm}) = -27.34 + 33.34 \times V_{(VDM)} \dots\dots\dots(7)$$

By using the linear equation number (7) above we found the power of the RF signal input or output from mobile phone devices, in this equation by recording the reading of the digital voltmeter that we putted in the output of the circuit to measured the (D.C) voltages ($V_{(VDM)}$)

The calibration of the circuit can be achieved by calculation. [11,12], in the same way of finding the equation (7). For example if we done a measurement and obtained a digital voltmeter reading ($V_{(VDM)}$) of (0.6v) the equation number (7) generated a power of (-7.336 dBm) while by using a standard (calibrated) RF power meter type (HP431, 432 or HP435) the power was read of (-7.612 dBm) with percentage of error was little more than (25%).

4- Tests and results:

The circuit in figure (3) was used for tested the RF power to different types of mobile for different ranges and types of mobile services (like out call or calling, requesting messages) using the server of a certain communication mobile company with identity number of (0964-79xx-xxxxxx) and the results was recorded as curves as shown below:

We had chosen for our test two types of mobile cellar phones, first the ZTC 777 (commercial name Panda) made in china with energy transmission of (1.4μ J/bit), and energy received of (0.31μ J/bit). The second type of mobile cellar phone was a Nokia 6600 made in Finland with SAR of (0.44 W/Kg for body), energy transmission of (375n J/bit) and energy received of (65n J/bit). [10]

And by using the equation :-

$$\text{Power} = \text{Energy} / \text{Time} \dots\dots\dots(8)$$

We could find the power for any time of call or any type of mobile services.

4-1-ZTC 777 mobile (type panda):

4-1-1-Section (I)

We did the tests by putting the ZTC 777 mobile near the sensor of our circuit which is here the small antenna(LPA) at distance of (1 cm) this distance between the mobile transmission antenna (the Horne type) and the received antenna(LPA) in the circuit and we did two type of tests:

- 1- We tested and recorded the output voltage ($V_{(VDM)}$) for the mobile while calling a number (out call) through out the mobile company for a period of time and the result putted as a curve between the voltage and time as shown below:

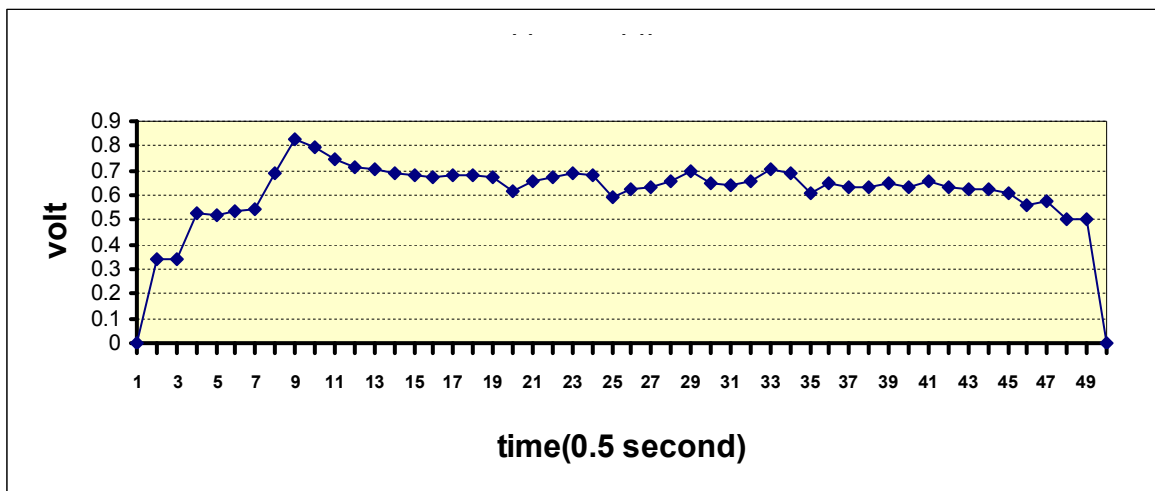

Figure (4) outcall for ZTC 777 mobile for distance of 1cm

- 2- We tested and recorded the output voltage ($V_{(VDM)}$) for the mobile while do request for the balance and receive a message back from the server of the mobile company for a period of time and the result putted as a curve between the voltage and time as shown below:

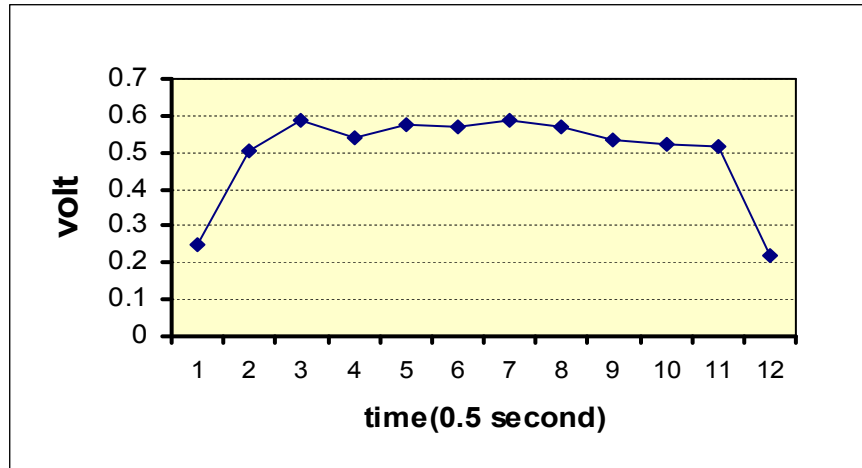

Figure (5) request for the balance and receive a message back for ZTC 777 mobile of a distance of 1cm

4-1-2-Section (II)

We did the tests by putting the **ZTC 777** mobile near the sensor of our circuit which is here the small antenna(LPA) at distance of **(3 or 5 cm)** this distances between the mobile transmission antenna (the Horne type) and the received antenna(LPA) in the circuit and we did two type of tests:

- 1- We tested and recorded the output voltage ($V_{(VDM)}$) for the mobile while calling a number (out call) through out the mobile company at distance of (3 cm) between the mobile transmission antenna and the received antenna(LPA) in the circuit for a period of time and the result putted as a curve between the voltage and time as shown below:

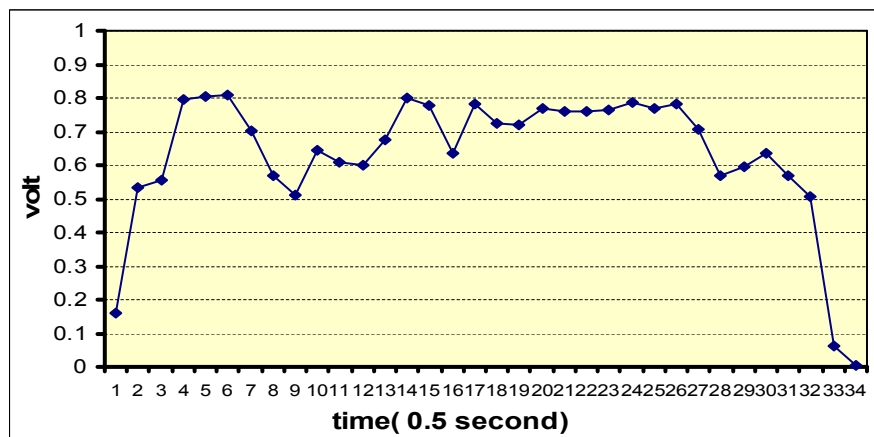

Figure (6) outcall for ZTC 777 mobile for distance of 3cm

2- We tested and recorded the output voltage ($V_{(VDM)}$) for the mobile while do request for the balance and receive a message back from the server of the mobile company at distance of (5 cm) between the mobile transmission antenna and the received antenna(LPA) in the circuit for a period of time and the result putted as a curve between the voltage and time as shown below:

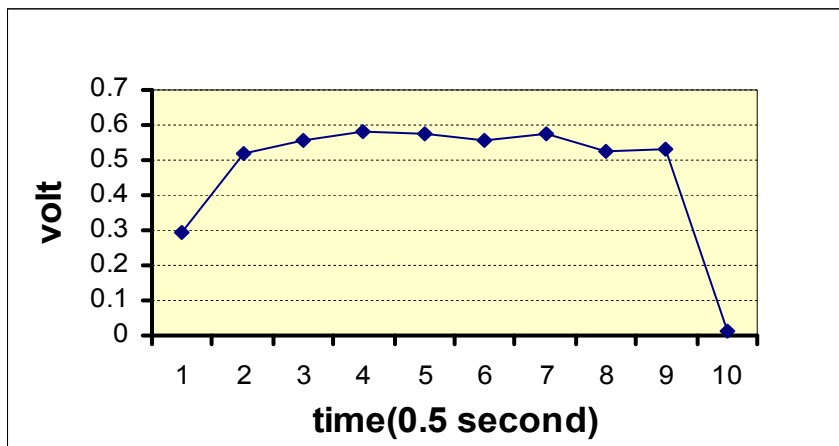

Figure (7) request for the balance and receive a message back for ZTC 777 mobile of a distance of 5cm

4-2- Nokia 6600 mobile:

4-2-1-Section (I)

We do the tests by putting the Nokia 6600 mobile near the sensor of our circuit which is here the small antenna(LPA) at distance of (1 cm) this distance between the mobile transmission antenna (the Horne type) and the received antenna(LPA) in the circuit and we do two type of tests:

1- We tested and recorded the output voltage ($V_{(VDM)}$) for the mobile while calling a number (out call) through out the mobile company for a period of time and the result putted as a curve between the voltage and time as shown below:

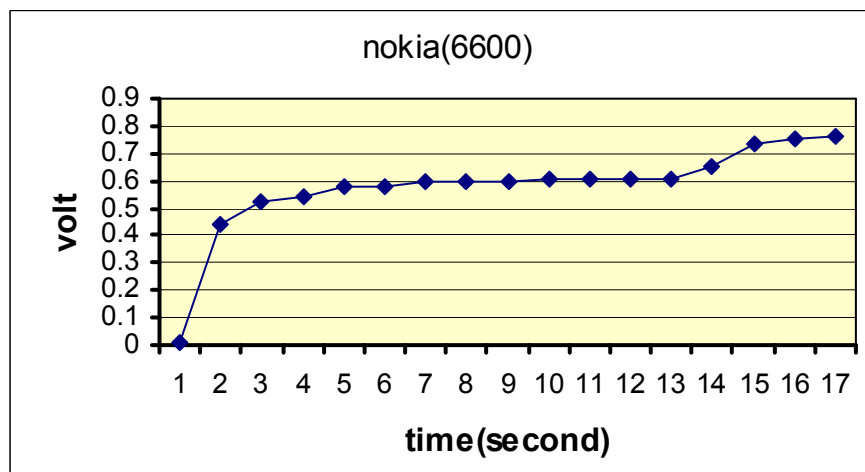

Figure (8) outcall for Nokia 6600 mobile for distance of 1cm

- 2- We tested and recorded the output voltage ($V_{(VDM)}$) for the mobile while do request for the balance and receive a message back from the server of the mobile company for a period of time and the result putted as a curve between the voltage and time as shown below:

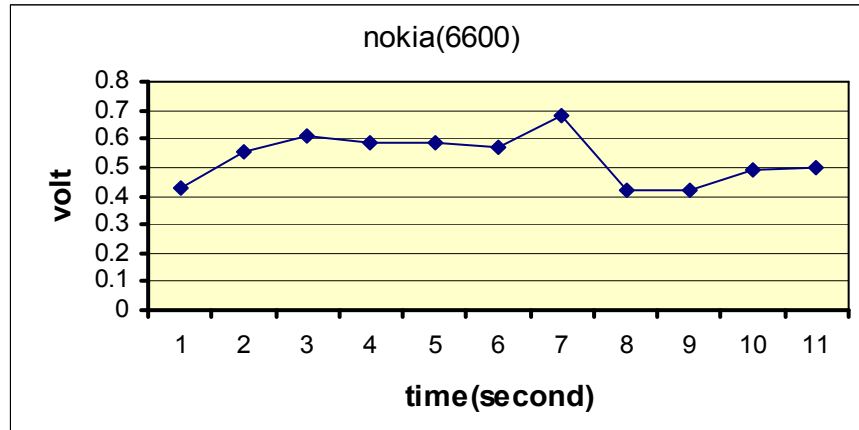

Figure (9) request for the balance and receive a message back for Nokia 6600 mobile of a distance of 1cm

4-2-2-Section (II)

We did the tests by putting the Nokia 6600 mobile near the sensor of our circuit which is here the small antenna(LPA) at different distances these distances are the distances between the mobile transmission antenna (the Horne type) and the received antenna(LPA) in the circuit and we do two types of tests:

- 1- We tested and recorded the output voltage ($V_{(VDM)}$) for the mobile while calling a number (out call) through out the mobile company at distance of (5 cm) between the mobile transmission antenna and the received antenna(LPA) in the circuit for a period of time and the result putted as a curve between the voltage and time as shown below:

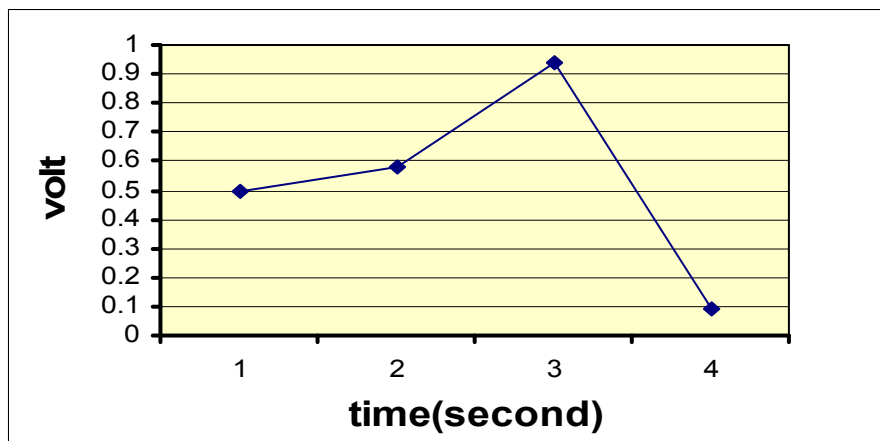

Figure (10) outcall for Nokia 6600 mobile for distance of 5cm

2- We tested and recorded the output voltage ($V_{(VDM)}$) for the mobile while do request for the balance and receive a message back from the server of the mobile company at distance of (5 cm) between the mobile transmission antenna and the received antenna(LPA) in the circuit for a period of time and the result putted as a curve between the voltage and time as shown below:

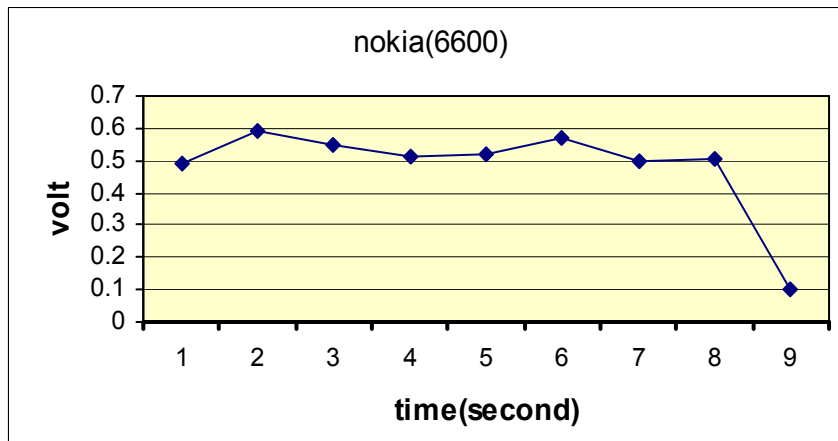

Figure (11) request for the balance and receive a message back for Nokia 6600 mobile for distance of 5cm

The result can be summarized by finding the averages of the output voltage ($V_{(VDM)}$) for a certain time with each and also by finding the maximum value of the output voltage ($V_{(VDM)}$), this are achieved and can be shown in the tables bellow for each type of mobile at different distances between the mobile and the small antenna(LPA) of the circuit:

1- The Nokia 6600 mobile tables :

A- Table (1), the distance between the mobile and the small antenna (LPA) of the circuit was (1 cm):

Table (1) summarized table of Nokia 6600 mobile for the $V_{(VDM)}$ reading at distance 1cm

Nokia 6600		$V_{Average}$ in volt	$V_{maximum}$ in volt
The distance is 1 cm	Out call calling	0.610375	0.762
	Requesting for balance with message back	0.531	0.68

B- Table (2), the distance between the mobile and the small antenna (LPA) of the circuit was (5 cm):

Table (2) summarized table of Nokia 6600 mobile for the $V_{(VDM)}$ reading at distance 5cm

Nokia 6600		$V_{Average}$ in volt	$V_{maximum}$ in volt
The distance is 5 cm	Out call calling	0.5245	0.938
	Requesting for balance with message back	0.481556	0.594

2- ZTC 777 mobile (Panda) tables:

A- Table (3), the distance between the mobile and the small antenna (LPA) of the circuit was (1 cm):

Table (3) summarized table of ZTC 777 mobile (Panda) mobile for the $V_{(VDM)}$ reading at distance 1cm

ZTC 777 mobile Panda		$V_{Average}$ in volt	$V_{maximum}$ in volt
The distance is 1 cm	Out call calling	0.6313	0.828
	Requesting for balance with message back	0.497333	0.588

B- Table (4), the distance between the mobile and the small antenna (LPA) of the circuit was (3 cm):

Table (4) summarized table of ZTC 777 mobile (Panda) mobile for the $V_{(VDM)}$ reading at distance 3cm

ZTC 777 mobile Panda		$V_{Average}$ in volt	$V_{maximum}$ in volt
The distance is 3 cm	Out call calling	0.630706	0.788
	Requesting for balance with message back	0.47345	0.582

5-Discussion:

The real distance between the human head and the mobile which often used is about 1 cm or less (it's the distance between the human ear and the mobile butted on its head for hearing the sound of the voice of a call). This distance is interest since we have seen from the results above that the distance of (1 cm) having largest value than the other distances.

An out call (calling) for long time say (about 10 hour continually) and using a the **ZTC 777** mobile can be assumed to be accumulated RF power and from equation (7) and equation (1) the value is:

$$P \text{ (dBm)} = -27.34 + 33.34 \times (0.6313) = -6.3$$

$$-6.3 = 10 \log_{10} \{P/1\text{mW}\}$$

$$P = 0.2344 \text{ mW}$$

$$\text{For 10 hour continually } P = 0.2344 \times 10 \times (36000/25) = 3375.69 \text{ mW}$$

$$P(\text{dBm}) = 35.28$$

And the standard safe value was (0.08 W/Kg) thus for a human that had a weight of (75 Kg):

$$P \text{ standard (w)} = 0.08 \times 75 = 6$$

$$P \text{ standard (dBm)} = 37.78$$

Which is really near the acceptable ranges and if we use acceded that time of using the cellars mobiles we may alter our self to danger.

Outer noise and the in circuit noise have very small or its have no effect on our circuit, since the frequency rang that we work with it are very high (0.9GHz-1.8GHz) and the noise generally are low frequency ranges. Additionally there are a very few appliances (home or office devices) works with that range.

We can notes from the results that the chine's mobiles have a transmission or induce voltages that lead to greater EMF strength greater than the European types. So, that leads us for our health to be in safe from the effect of mobiles phones as possible, keep the mobile away from the sensitive parts of your body (the brain, hart).

The Korean mobile types (Samsung and LG) are the same as the chine's mobile from the construction and transmission power or EMF strength. also the out call (calling) have a larger transmission power or induce voltage than the in call) receiving a call). Finally the best way for using cellars mobiles can be by butting the cellars mobiles away far as we could from us (the human body) for example by using head phones as an example in calling and receiving calls.

6-References:

1. West Wilson, Medison "*Electromagnetic fields*", Developed by Wisconsin Division of Public Health, Bureau of Environmental Health, 1 W1 53701, PPH7103 (revised 11/00),2005.
2. Leif G. Salford,¹ Arne E. Brun,² Jacob L. Malmgren,⁴ and Bertil R. R. Persson³"*Nerve Cell Damage in Mammalian Brain after Exposure to Microwaves from GSM Mobile Phones*" , Environmental Health Perspectives . VOLUME 111/NUMBER 7/JUNE ,2003.
3. WHO fact," *Electromagnetic fields and Public Health, Exposure to Extremely high frequency fields*" .sheet No.322, June 2007.
4. H. Seitz,* D.Stinnera,¹,Th. Eikmanna,¹, C. Herr a,¹, M. Ro'o'slib,², "*Electromagnetic hypersensitivity (EHS) and subjective health complaints associated with electromagnetic fields of mobile phone communication-a literature review published between 2000- 2004*" 21 June 2005.
5. R. HUBER , V . TREYER², A. A. BORBE ' LY¹ , J. SCHUDERER³ , J . M. GOTTSELING¹ , H,-P. LANDOLT¹, E. WERTH¹, T.BERTRHOLD² , N, KUSTER³, A. BUCK² and P . ACHERMANN¹,"*Electromagnetic. elds, such as those from mobile phone, alter regional cerebral blood .ow and sleep and waking EEG*" ,21 August2002.
6. International Commission on Non-Ionizing Radiation Protection (ICNIRP), "*Guidelines for limiting exposure to time-varying electric, magnetic, and electromagnetic fields (up to 300 GHz)*", Health Physics, Vol 74, No 4, pp 494-522, April 1998.
7. Department of health, republic of south Africa." limits for human exposure to time-varying electric, magnetic, and electromagnetic fields (up to 300 GHz)", Directorate: Radiation Control January 2002
8. Clayton R. Paul ,"*Introduction to electromagnetic compatibility*", Wiley series in microwave and optical engineering, New York,1992.
9. James J. Brophy ,"*Basic electronics for scientists*" (5th edition), McGraw. Hill , Boston,1990.
10. www.ALLDATASHEET.com
11. Making better electric field measurement, ETS.LINDGREEN(an Esco technologlss company) 2005, www.ets.lindgreen.com
12. Krzysztof Gryz, Jolanta Karpowicz ,"*UNCERTAINTY OF MESUREMENTS DEVICES CALIBRATION*", Center Institute for Protection- National Research Institute, Laboratory of Electromagnetic Hazards, Warszawa, Poland Krgry@ciop.pi.2000.