

The Effect of Increasing Sub-Cooling on Air-Cooled A/C System's Capacity

Prof. Dr. Ghanim K. Abdul Sada

*Mechanical Engineering Dept., College of Eng.
Al-Mustansiriya University, Baghdad, Iraq*

Asst. Prof. Dr. M. N. Hamid

*Mechanical Engineering Dept., College of Eng.
Al-Mustansiriya University, Baghdad, Iraq*

Dr. Arkan F. Said

*Power Production Office
Ministry of Electricity, Baghdad, Iraq*

Abstract

The present research covers the effect of adding extra water-cooled condenser in series with the main vapor compression refrigeration system as a heat sink source for system sub-cooling. An experimental laboratory study has been done on a split unit air-conditioner with a (24000 Btu/hr) nominal capacity, taking into consideration the effect of outdoor ambient temperature and cooling load.

A high accuracy fully instrumented experimental rig interfaced with a computer has been constructed, especially designed for refrigerant R22, using a capillary tube with size chosen according to ASHRAE to control the refrigerant mass flow rate. The extra refrigerant sub-cooling temperature difference was between $\Delta T_{SC} = 5\text{ }^{\circ}\text{C}$ and $10\text{ }^{\circ}\text{C}$, this value was chosen in order to not to exceed the limits of the original system sub-cooling. The experimental results show that there is an increase in the system capacity by +1.37% to +7.065% when $\Delta T_{SC} = 5\text{ }^{\circ}\text{C}$, for ambient temperature between $T_{amb} = 30\text{ }^{\circ}\text{C}$ and $46\text{ }^{\circ}\text{C}$, and +4.1% to +14.13% when $\Delta T_{SC} = 10\text{ }^{\circ}\text{C}$ for the same previous T_{amb} . The power consumed per ton of refrigeration shows a decrease by -0.948% to -3.417% for $\Delta T_{SC} = 5\text{ }^{\circ}\text{C}$, and -2.84% to -7.745% for $\Delta T_{SC} = 10\text{ }^{\circ}\text{C}$ for the same ambient temperature previously mentioned.

The benefit from the sub-cooling technique is higher in regions with high and constant-year round temperatures, where there is no previous analytical and experimental study for systems with air-cooled condensers, but still covers the installation of the extra equipments costs. Moreover, the compressor and the condenser can be downsized due to the increase in the effective capacity.

الخلاصة

تم في هذا البحث دراسة تأثير زيادة درجة حرارة مائع التثليج الخارج من المكثفة بواسطة التبريد الإضافي الفائق وذلك باستخدام مبادل حراري إضافي مبرد بالماء من نوع الأنبوب المزدوج متعاكس الجريان، تم ربطه على التوالي مع منظومة التثليج الانضغاطية الأساسية.

تم ذلك بواسطة إجراء دراسة عملية مختبرية على وحدة تبريد منفصلة ذي سعة تبريد 24000 Btu/hr آخذين بنظر الاعتبار تأثير درجة حرارة الهواء الخارجي والحمل التبريدي، وذلك باستخدام منظومة مختبرية ذات أجهزة قياس عالية الدقة مرتبطة بالحاسوب تم تصميمها وتنفيذها على أساس استخدام مائع التثليج فريون 22، وباستخدام أنبوب شعري تم اختيار حجمه (قطره وطوله) بالاعتماد على بيانات ASHRAE للسيطرة على معدل الجريان لمائع التثليج. وتم اختيار درجة حرارة التبريد الإضافي الفائق لمائع التثليج ما بين $5^{\circ}C$ إلى $10^{\circ}C$ ، وذلك لغرض عدم تجاوز حدود التبريد الإضافي الفائق للمنظومة الأساسية.

أعطت هذه الدراسة نتائج عملية جيدة جداً، حيث أعطت زيادة في سعة المنظومة بمقدار $+1.37\%$ ولغاية $+7.065\%$ عند درجة حرارة تبريد إضافي فائق ($5^{\circ}C$) وعند درجة حرارة الهواء الخارجي ما بين $30^{\circ}C$ ولغاية $46^{\circ}C$ ، كذلك أعطت زيادة بمقدار $+4.1\%$ ولغاية $+14.13\%$ عند درجة حرارة تبريد إضافي فائق $10^{\circ}C$ ولنفس درجة حرارة الهواء الخارجي السابقة. أما القدرة المستهلكة لكل وحدة طن تبريدي فقد كانت بمقدار -0.948% ولغاية -3.417% عند درجة حرارة تبريد إضافي فائق $5^{\circ}C$ ، وأيضاً أعطت نقصان بمقدار -2.84% ولغاية -7.745% عند درجة حرارة تبريد إضافي فائق $10^{\circ}C$ ، ولنفس درجات حرارة الهواء الخارجي السابقة الذكر.

إن الاستفادة من تقنية التبريد الإضافي الفائق لمائع التثليج كانت أكبر في المناطق ذي درجات الحرارة العالية على مدار السنة، حيث لا يوجد أي دراسة عملية أو تحليلية للأنظمة ذي المكثفات المبردة بالهواء، ولكنها لا تزال تغطي تكاليف إضافة الأجهزة الإضافية. بالإضافة لذلك فمن الممكن خفض حجم الضاغطة ووحدة التكثيف نتيجة للزيادة الحاصلة في سعة المنظومة الفعالة.

1. Introduction

The increase in the ambient temperatures due to the extreme ambient circumstances, reaches the limits that affect the air-conditioner performance, which leads to decrease its coefficient of performance and as a result its cooling capacity, and increasing the electrical power consumption, making it necessary to improve the performance of these equipments under the new design working conditions.

The refrigerant sub-cooling is a demonstrated and reliable way of increasing cooling capacity, and it is proving to have energy-saving potential to conventional air-conditioning systems ^[1].

Therefore, the present study has come as one of the solutions within this field, in order to buildup a database for performance improvement of refrigeration and air-conditioning devices, with simplest possible methods and minimum costs, especially that the world nowadays is going through minimizing the performance improvement costs for this type of devices within the free economy facts of the world.

2. Experimental Method (Apparatus and Procedure)

The present investigation used a refrigeration system based on vapor compression cycle, consisting of the four major parts: Compressor, Condenser, Capillary tube, and Evaporator, with a dummy load represented by special heaters to appropriate the test room size and refrigeration system capacity. The refrigeration system represented by a split unit air-conditioner, with (24000 Btu/hr) nominal capacity.

A water cooled tube-within-tube heat exchanger was installed in series with the main refrigeration system as a heat sink source for increasing the refrigerant sub-cooling temperature difference.

Preparing operation plays an important rate in amelioration of the experimental measurement techniques, which takes into consideration the combination of the main effective parameters (Ambient temperature, Condensing pressure and temperature, Evaporating pressure and temperature, Refrigerant and water mass flow rate, and Dummy cooling load). A high accuracy-fully instrumented experimental rig, interfaced with a PC-computer has been constructed, especially designed for refrigerant R22.

The time was too long to take the measurement variations of the ambient temperature (during the summer season), due to the fact that the condensing unit was located in the outdoor of the laboratory. Therefore, it was decided to run the test rig (5 to 10) times at a specified ambient temperature (T_{amb}) with different times along the daylight especially at noon. The data was triggered on the PC-logger when the system reaches the steady state.

3. Experimental Results

The air-conditioning system investigated in present study has been divided into several sections in order to take the proper measurements with the proper devices, as shown in **Fig.(1)**. The following expressions have been used in the calculations as demonstrated by ^[2]:

$$\text{Evaporation: } \quad Q_{\text{evap}} = \dot{m}_r \cdot (h_8 - h_{13}) \dots\dots\dots (1)$$

$$\text{Compression: } \quad W_{\text{comp}} = \dot{m}_r \cdot (h_{11} - h_8) \dots\dots\dots (2)$$

$$\text{Condensation: } \quad Q_{\text{cond}} = \dot{m}_r \cdot (h_{11} - h_5) \dots\dots\dots (3)$$

$$\text{Expansion: } \quad h_{13} = h_5 \dots\dots\dots (4)$$

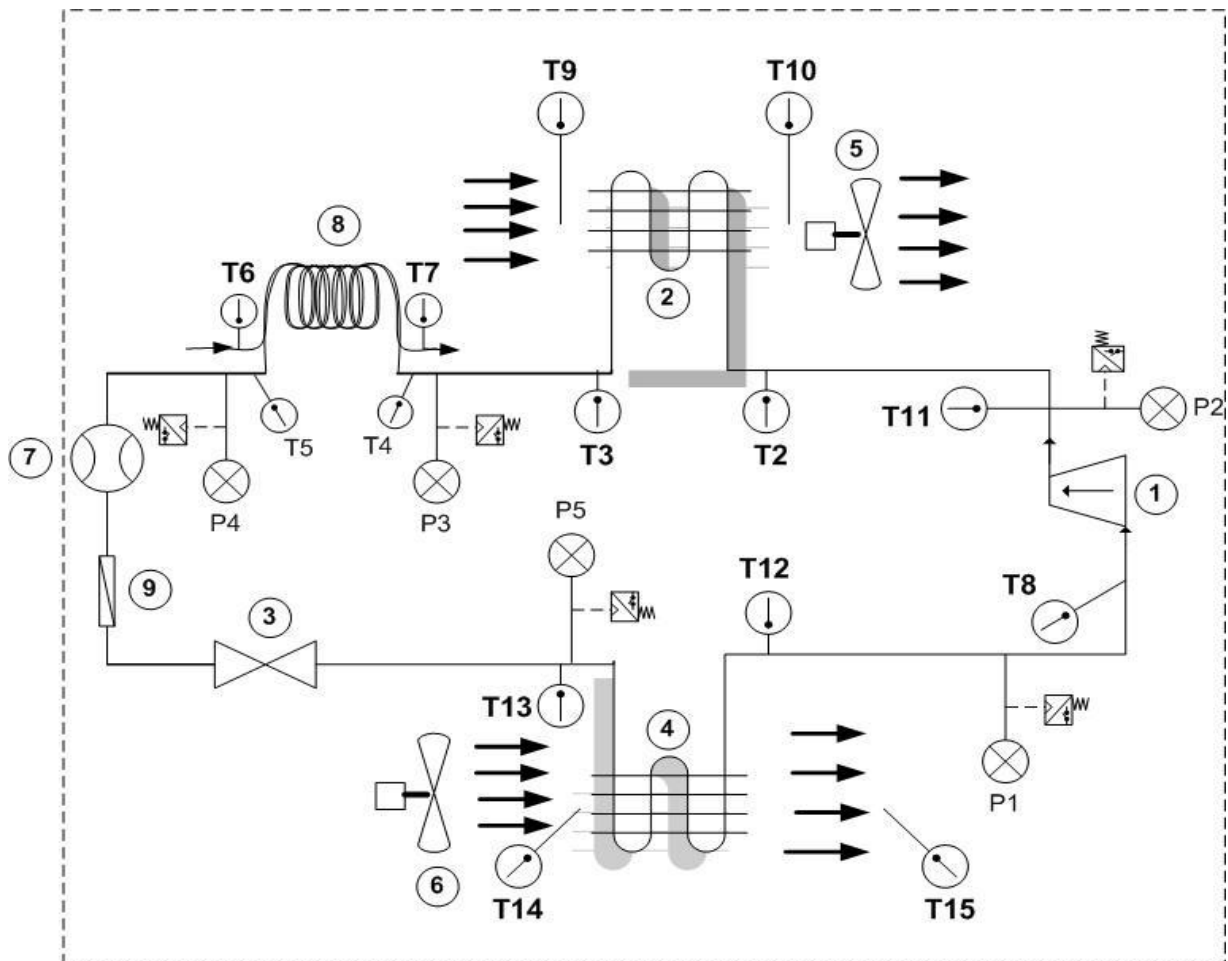

Part No.	Description
1	Compressor
2	Condenser
3	Capillary Tube
4	Evaporator
5	Condenser Fan
6	Evaporator Fan
7	Rotameter
8	Tube-within-Tube Heat Exchanger
9	Filter
10	Computer mini tower with data acquisition cards
11	Keyboard & Monitor
T1...15	Temperature sensors
P1...5	Pressure gauges and transducers

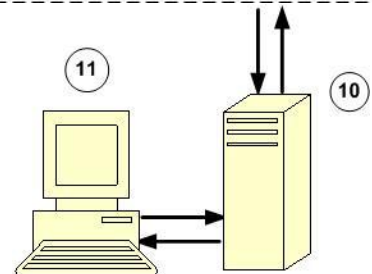

Figure (1) Vapor compression cycle with water cooled heat exchanger and data acquisition connection

The system capacity has been measured experimentally; **Fig.(2)** represents the effect of outdoor ambient temperature on the refrigeration effect on a (p-h) diagram of the system. The tube-within-tube heat exchanger has been used as a liquid sub-cooler, and tap city water was used as a heat sink source in order to increase the refrigerant sub-cooling temperature difference (ΔT_{SC}). **Figure (3)** shows the relationship of the water mass flow rate as a function of the sub-cooling temperature difference (ΔT_{SC}).

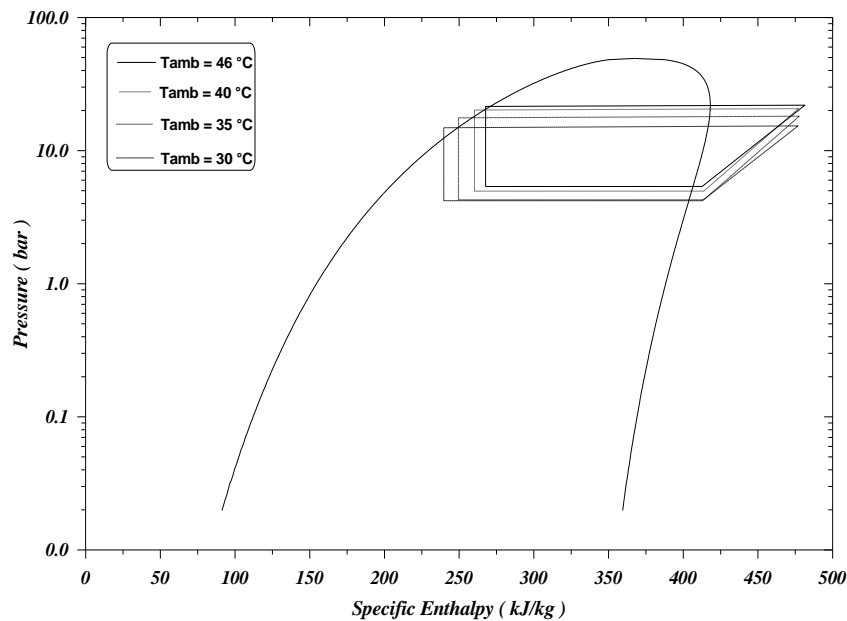

Figure (2) Effect of outdoor temperature on (p-h) diagram

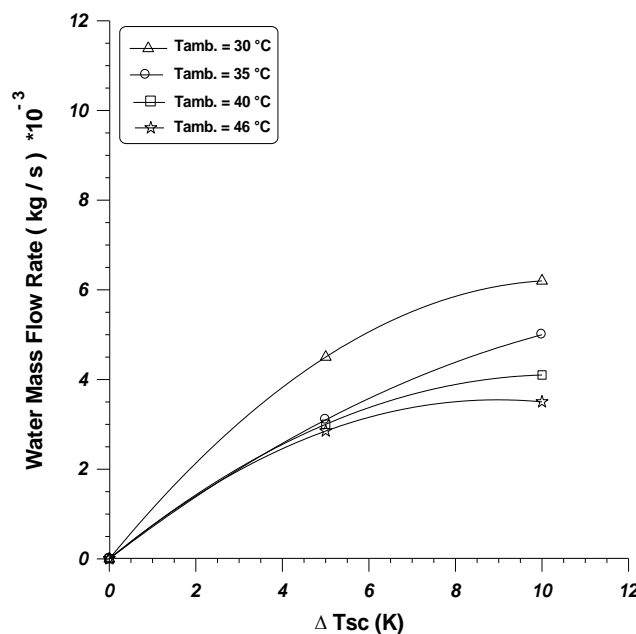

Figure (3) Variation of water mass flow rate with Sub-cooling temperature difference

Figure (4) represents the variation of refrigerant mass circulated per unit capacity with (ΔT_{SC}). Figures (5), (6), (7), and (8) show the effect of the refrigerant sub-cooling by using the tube-within-tube heat exchanger on the overall performance of the vapor compression cycle for ($T_{amb} = 40^\circ\text{C}$ and 46°C) on (p-h) and (T-s) diagrams respectively.

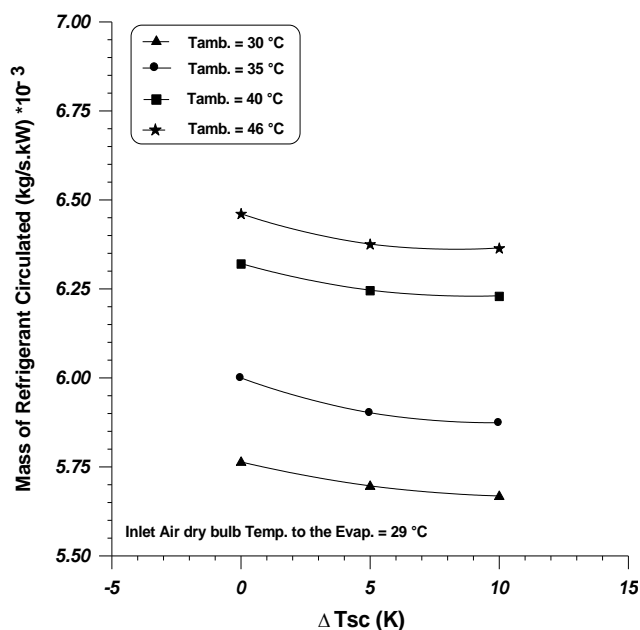

Figure (4) Variation of refrigerant mass/kW with Sub-cooling temperature difference

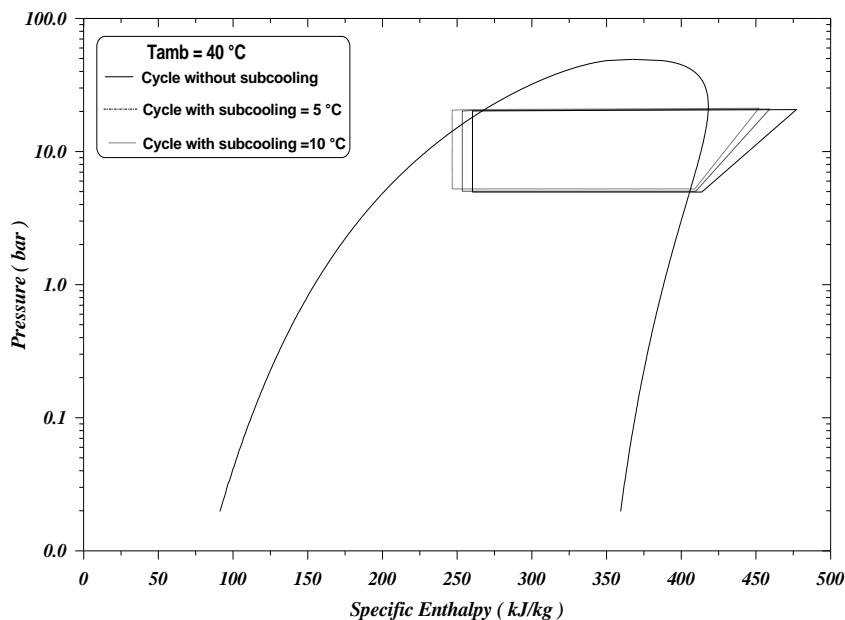

Figure (5) Effect of sub-cooling temperature on (p-h) diagram of $T_{amb} = 40^\circ\text{C}$

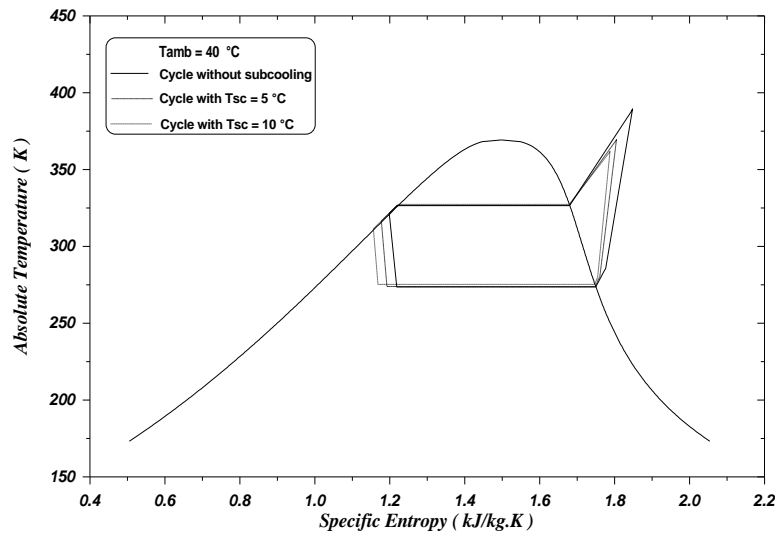

Figure (6) Effect of sub-cooling temperature on (T-s) diagram of $T_{amb} = 40^{\circ}\text{C}$

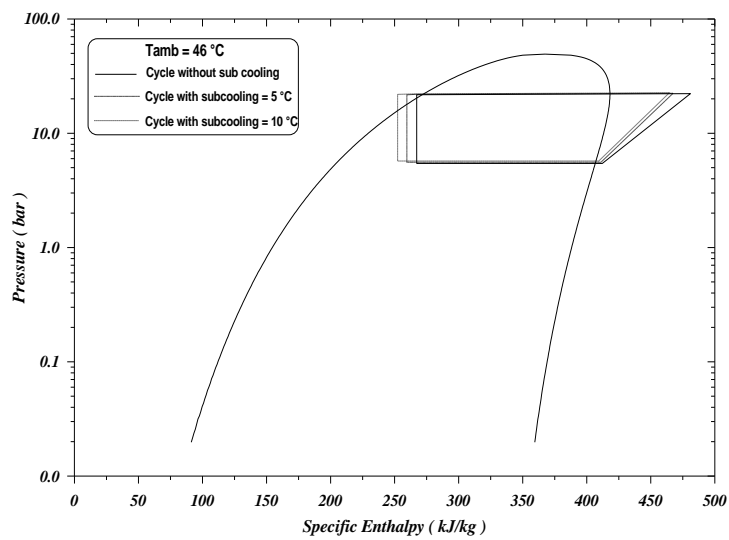

Figure (7) Effect of sub-cooling temperature on (p-h) diagram of $T_{amb} = 46^{\circ}\text{C}$

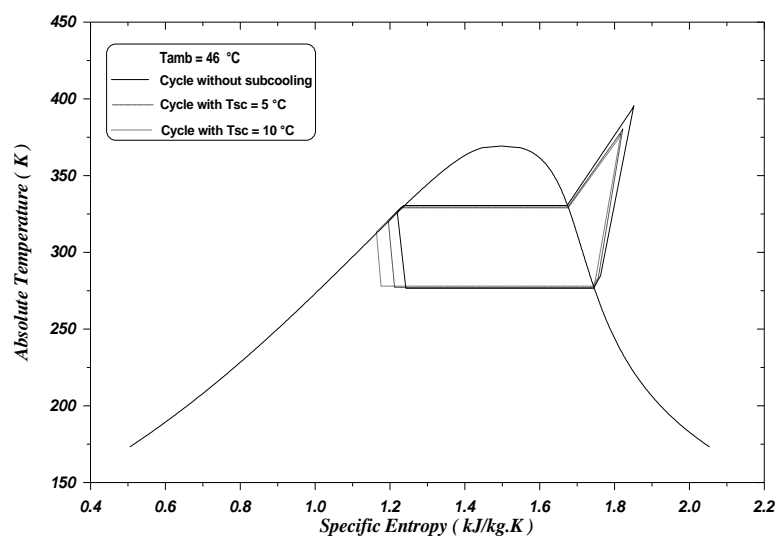

Figure (8) Effect of sub-cooling temperature on (T-s) diagram of $T_{amb} = 46^{\circ}\text{C}$

Figure (9) shows the variation of the system capacity with the ambient temperature for different (ΔT_{SC}) of the system. Figure (10) shows the variation of the compressor work with the ambient temperature for different (ΔT_{SC}). The effect of (ΔT_{SC}) on the average system capacity can be shown in Fig.(11). Figure (12) represents the variation of the coefficient of performance with the ambient temperature for different values of (ΔT_{SC}).

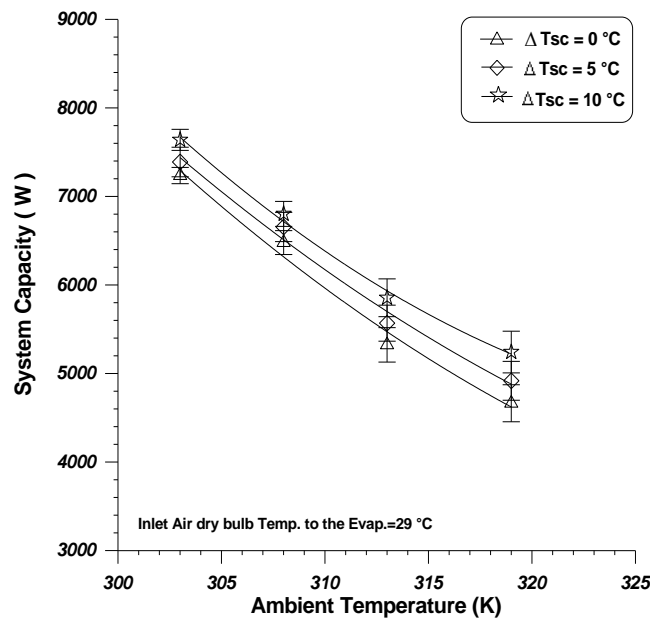

Figure (9) Variation of cooling capacity with outdoor ambient temperature

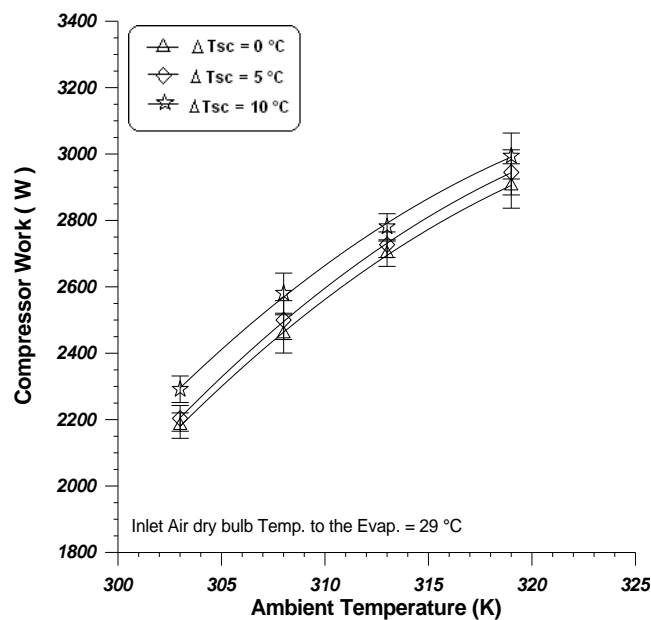

Figure (10) Variation of compressor work with outdoor ambient temperature

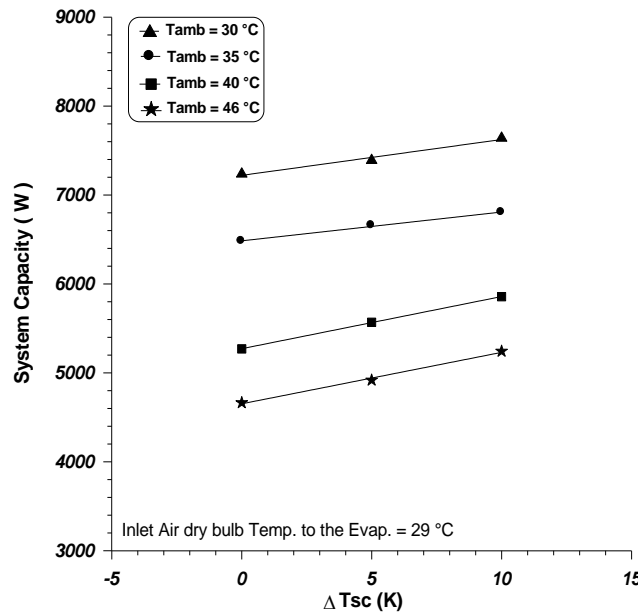

Figure (11) Variation of system capacity with Sub-cooling temperature difference

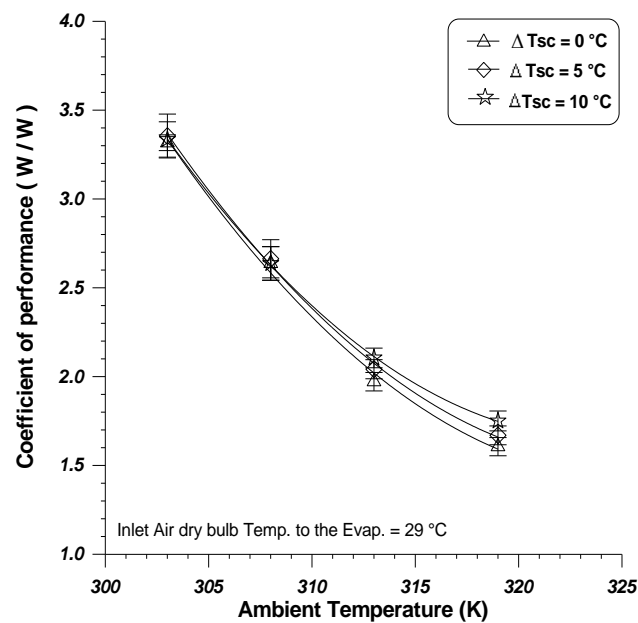

Figure (12) Variation of COP with outdoor ambient temperature

Figure (13) demonstrates the effect of ambient temperature on the power consumed per ton of refrigeration for different values of (ΔT_{SC}), and to be more specific, Fig.(14) shows the variation of power/TR with (ΔT_{SC}).

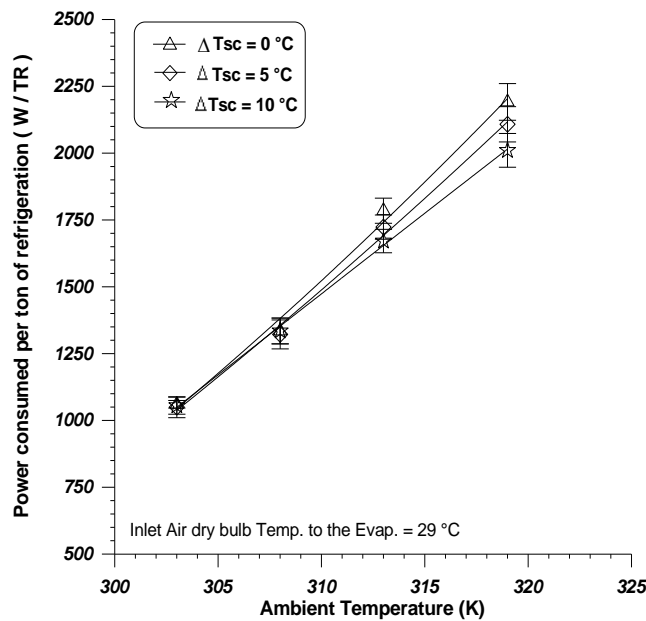

Figure (13) Variation of power/TR with outdoor ambient temperature

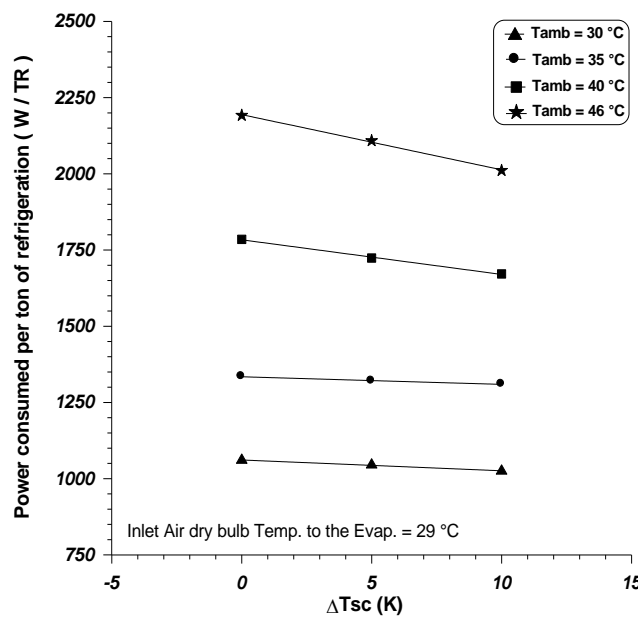

Figure (14) Variation of power/TR with Sub-cooling temperature difference

The Energy Efficiency Ratio (EER), which represents the ratio of refrigeration capacity in (Btu/hr) to the total power consumed by the system in (Watt), including the power consumed by the condenser and evaporator fans [3], and is used to evaluate the HVAC unit. **Figure (15)** represents the variation of EER with ambient temperature for different (ΔT_{SC}). And the effect of sub-cooling on the system capacity in conjunction with EER can be represented by **Fig.(16)**.

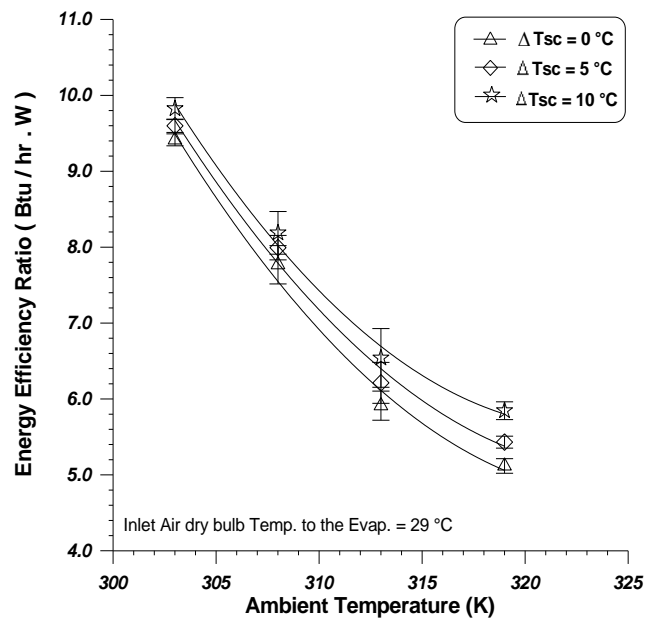

Figure (15) Variation of EER with outdoor ambient temperature

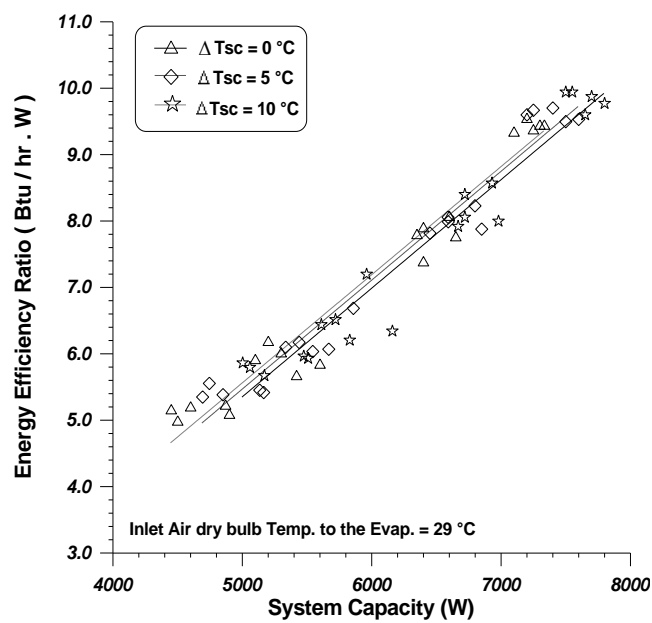

Figure (16) Variation of EER with system cooling capacity

Figures (17) and (18) show the variation of (ΔT_{SC}) and its effect on the vapor compression cycle on a (p-h) diagram for different (T_{amb}).

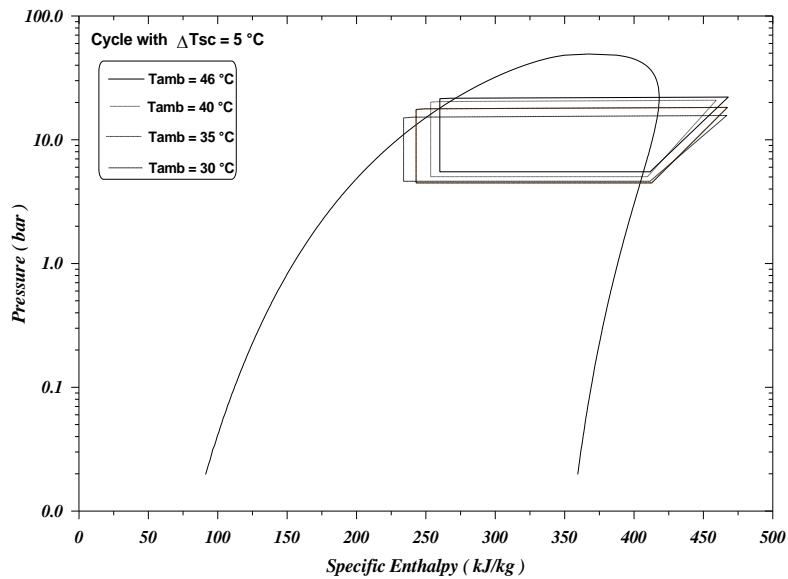

Figure (17) Effect of $\Delta T_{sc} = 5 \text{ }^\circ\text{C}$ on (p-h) diagram of variable T_{amb}

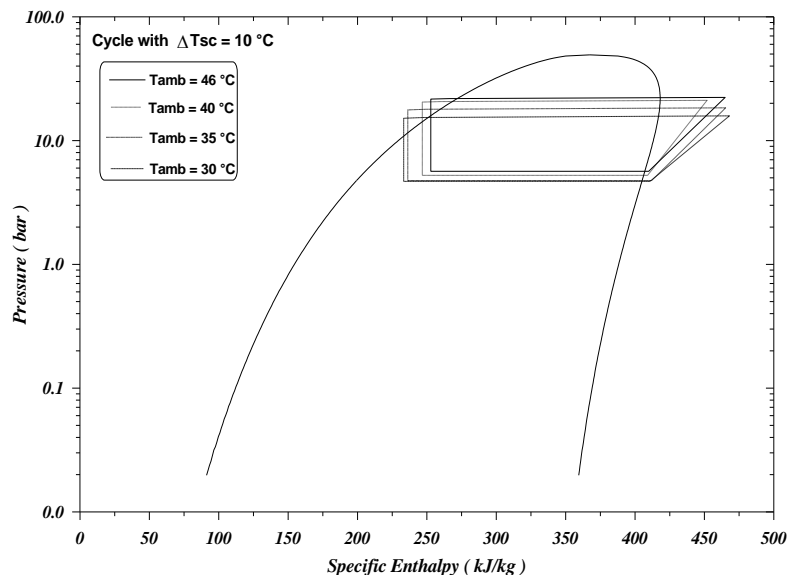

Figure (18) Effect of $\Delta T_{sc} = 10 \text{ }^\circ\text{C}$ on (p-h) diagram of variable T_{amb}

4. Discussion and Conclusions

The outdoor ambient temperature is one of the most dominant parameters that affect the refrigeration systems. As noticed from **Fig.(2)**, the increase in outdoor ambient temperature yields a decrease in refrigeration effect due to the increase in condensing temperature which consequently yields an increase in condensing pressure, in addition to decreasing the sub-cooling temperature difference and reducing the amount of heat rejected from the condenser. Also, this will yield an increase in power consumed by the compressor and as a result the COP will decrease, and consequently the EER will also decrease. The system capacity and other parameters have been measured experimentally in this work, as shown in **Figs.(2), (9), (10), (12), and (15)**.

In this work, a water cooled tube-within-tube heat exchanger has been used as a liquid sub-cooler, in order to increase the refrigerant sub-cooling temperature difference. The relationship between sub-cooling temperature difference and the water mass flow rate is shown in **Fig.(3)**, where the water mass flow rate increases as the ambient temperature increases at the same (ΔT_{SC}). This trend of curves seems to be reasonably acceptable due to the fact that the more temperature difference is wanted, the more heat will be rejected, and then the more water mass flow rate will be needed.

On the other side, the increase in the ambient outdoor temperature is associated with a decrease in water mass flow rate. This is due to the fact that the refrigerant mass flow rate is restricted by the sub-cooled vapor compression cycle which is fairly higher than the standard vapor compression cycle, and the sub-cooling temperature difference is pre-defined by the user. As a result of heat balance in the cooling coils, the water mass flow rate is decreased. **Figure (4)** shows the variation of refrigerant mass circulated per unit capacity with sub-cooling temperature difference, which indicates that higher sub-cooling (ΔT_{SC}) yields lower mass of refrigerant circulated which is a good indication that the volume of vapor which the compressor must handle per unit capacity will also be less than the standard cycle, which means longer compressor life [4,5,6].

It should be noticed that the increase in capacity is associated with a slight increase in power consumed by the compressor as shown in **Fig.(10)**. **Table (1)** indicates the percentage of increasing or decreasing the most important dominant parameters that represents the system performance:

Table (1) The percentage of increasing or decreasing the system performance parameters

ΔT_{SC}	5 °C					10 °C				
T_{amb} (°C)	Q_{cap} %	W_{comp} %	COP %	EER %	P/ton %	Q_{cap} %	W_{comp} %	COP %	EER %	P/ton %
30	+1.37	+0.917	+0.6	+2.13	-0.948	+4.1	+5.5	+1.818	+4.26	-2.84
35	+3.64	+1.626	+2.742	+2.56	-1.487	+7.6	+4.88	+4.67	+5.13	-1.86
40	+3.64	+1.48	+4.75	+4.918	-2.81	+8.182	+3.9	+7	+9.836	-5.618
46	+7.065	+1.55	+4.375	+5.825	-3.417	+14.13	+3.448	+10.63	+13.59	-7.745

As can be noticed from **Table (1)**, the increase in capacity (Q_{cap}) and power consumed by the compressor (W_{comp}), is associated with an increase in the COP and EER, with a decrease in power consumed per ton of refrigeration, as shown in **Figs.(12), (13), and (15)**.

As indicated in **Figs.(11), (14), (16), (17), and (18)** and from **Table (1)**, it can be noticed that the increase in capacity is useless at low ambient temperatures especially at ($\Delta T_{SC} = 10$ °C), because of the high power consumed by the compressor compared with the gain in system capacity. Therefore, it can be seen that the sub-cooling technique is

valuable at high ambient temperatures. Hence, it is concluded that the compressor and condensing unit can be downsized, which leads to a higher overall efficiency, lower electrical demand, and reduced energy consumption. Then as shown in **Table (1)**, the amount of energy saved depends on the climate conditions (outdoor dry bulb and wet bulb temperatures).

At low ambient conditions, the unit is oversized and the available capacity is greater than the load on the evaporator. Therefore, sub-cooling the refrigerant further will not yield any measurable increase in efficiency ^[7].

5. References

1. Dossat, R. J., *“Principles of Refrigeration”*, 3rd Edition, Prentice Hall, 1991.
2. Mc-Quiston, F. C., and Parker, J. D., *“Heating, Ventilating, and Air-Conditioning: Analysis and Design”*, 3rd Edition, John Wiley and Sons, New York, 1988.
3. Althouse, A. D., Turnquist, C. H., and Bracciano, A. F., *“Modern Refrigeration and Air Conditioning”*, The Goodheart-Willcox, South Holland, 1988.
4. ASHRAE Handbook, *“HVAC Systems and Equipments”*, Atlanta, American Society of Heating, Refrigeration, and Air Conditioning Engineers, Inc., New York, 1979.
5. ASHRAE Handbook, *“Refrigeration”*, Atlanta, American Society of Heating, Refrigeration, and Air Conditioning Engineers, Inc., New York, 1979.
6. ASHRAE Handbook, *“HVAC Applications”*, Atlanta, American Society of Heating, Refrigeration, and Air Conditioning Engineers, Inc., New York, 2000.
7. Federal Technology Alerts (FTA), *“Technology for Improving Cooling System Performance”*, A Publication Series Designed to Speed the Adoption of Energy-Efficient and Renewable Technologies in the Federal Sector, Department of Energy, USA, 1999.

Nomenclature

COP:	Coefficient of Performance in (W/W)
EER:	Energy Efficiency Ratio in (Btu/kW.hr)
h:	Enthalpy in (J/kg)
m_r :	Refrigerant mass flow rate in (kg/s)
Q_{cap} :	System capacity in (J/s)
Q_{cond} :	Heat rejected by the condenser in (J/s)
Q_{evap} :	Cooling load of the evaporator in (J/s)
T_{amb} :	Outdoor ambient temperature in (K)
T_{sc} :	Refrigerant Sub-cooling temperature in (K)
W_{comp} :	Compression work consuming by the compressor in (J/s)
Δ :	Difference of temperature