

## Fingerprint Recognition

Asist. Lecture Ahmed Salih Mahdi  
University of Mustansiriya  
Collage of engineering  
Computer Eng. Dept.  
Ms.c Computer Eng.

Asist. Lecture Ahlam Hanoon  
University of Mustansiriya  
Collage of engineering  
Computer Eng. Dept.  
Ms.c Control&computer Eng.

### Abstract

*This paper deals with the development of computational model for fingerprint recognition. A person can be recognized and identified by comparing the characteristics of his fingerprint with those of known individuals. Features of the fingerprint under test are compared with a set of enrolled fingerprints already stored in database. If the features match with the database then fingerprint can be recognized and identified. The most popular technique is Minutia Extraction for Fingerprint. The development of computation model for fingerprint recognition by using slantlet transform instead of FFT due to the ability of the slantlet transform to decompose signal (images at various resolutions allows accurate extraction of features from non stationary signal images). The low frequency coefficients which contain the maximum information about the signal, were selected from slantlet decomposition, these coefficient fed to another step in Minutia Extraction and then to Minutia Matching. This new method of fingerprint recognition tasks with lower number of calculations. Hence it raises the algorithmic efficiency and reduces the execution time. The proposed algorithm is tested upon a database consisted of 10 persons. An overall accuracy of recognition rate of the proposed approaches 100. The performance of this work has been evaluated by using MATLAB (2008 A) software.*

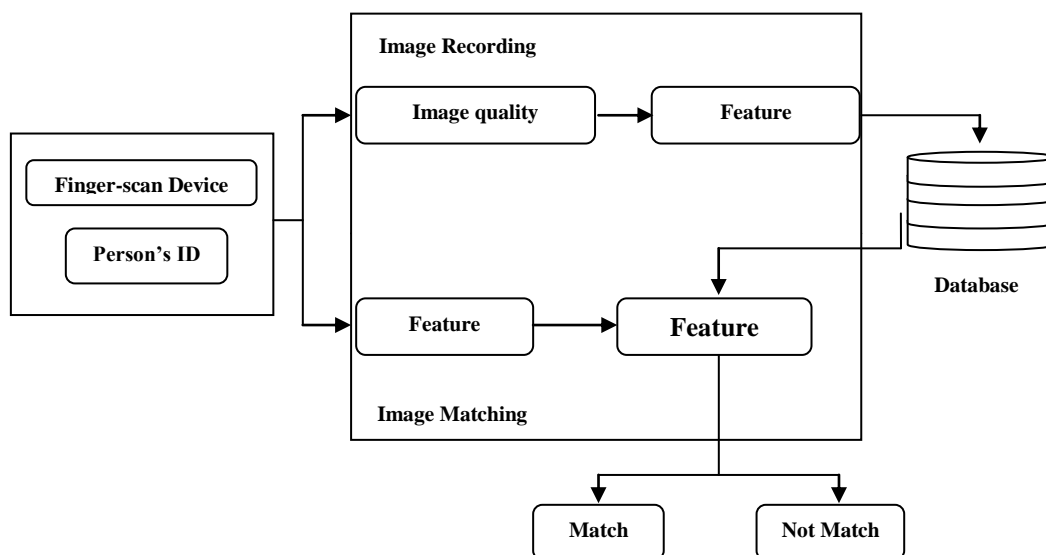
Keyword AFAS AFIA AFRS SLT FVC2002

### الخلاصة

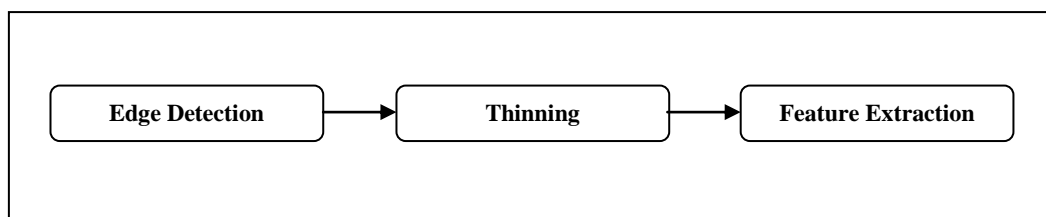
البحث تضمن طريقة حديثة لحساب ومعرفة كيفية بصمة الصبع لكل شخص بصمة مفردة وحيدة خاصة تميزه . لتميز اي شخص يتم استخلاص ادق الميزات التي توجد في اصبعه ومقارنتها مع قاعدة البيانات الخاصة ببصمات الاصابع لاشخاص المعرفين ومن خلال تطابق تلك البصمة مع اي بصمة في قاعدة البيانات يمكن التعرف على الشخص . الطريقة الحديثة لاستخلاص ادق الميزات لبصمة الاصبع استخدمت تحويل الموييل Slantlet Transformer بدل من Fast Fourier Transformer (FFT). حيث ان الموييل يتصف بقابلية كبيرة و عالية على تحليل الاشارات الصورية الى عناصر مختلفة لمرشحات مختلفة وبمستويات متعددة مما يسمح باستخلاص ادق المواصفات التي تحملها الاشارة. تحويل الموييل يحتوي على الترددات القليلة التي تحتوي على اغلب واعظم المعلومات الخاصة بالاشارة واختيرت تلك الترددات لاستخدامها في استخلاص ادق المواصفات للبصمة كمرحلة اولية والمطابقة للبصمة كمرحلة نهائية . تميزت الطريقة الحديثة بسهولة وبساطة وقلة واختصار الحسابات مما ادى الى اختصار الكثير من الوقت مما زاد من كفاءة الخوارزمية . تم اختبار عشرة بصمات لاشخاص مختلفين ودققت الخوارزمية تلك البصمات وكانت كفاءتها 100% . جودة الخوارزمية حسب استخدام برنامج حاسوب Matlab (2008 a).

## 1-Introduction

Automated Fingerprint Identification System AFIS. is the process of automatically matching one or many unknown fingerprint against a database of known and unknown prints. Automated fingerprint identification system are primarily used to be law enforcement agencies for criminal identification intestines, the most important of which identify a person suspected of committing a crime or linking a suspect to other unsolved crimes.A typical Automated Fingerprint Identification System is shown in Fig. (1). The feature extractor stages is shown in Fig. (2). Automated Fingerprint recognition is closely related technique used in application such as attendance and access control system <sup>[1]</sup>. On a technical level verification system verify a claimed identify (a user might claim to be presenting his PIN or ID card and verify his identity using his fingerprint). Whereas identification systems determines identity based solely on fingerprints.AFIS have used in large scale civil identification projects. Many states provinces and local administration region have their own systems. Which are used for variety of purposes, including criminal identification background checks, receipt of benefits and receipt of credentials (such as passport) <sup>[2]</sup>.



**Fig. (1) A typical Automated Fingerprint Identification System**



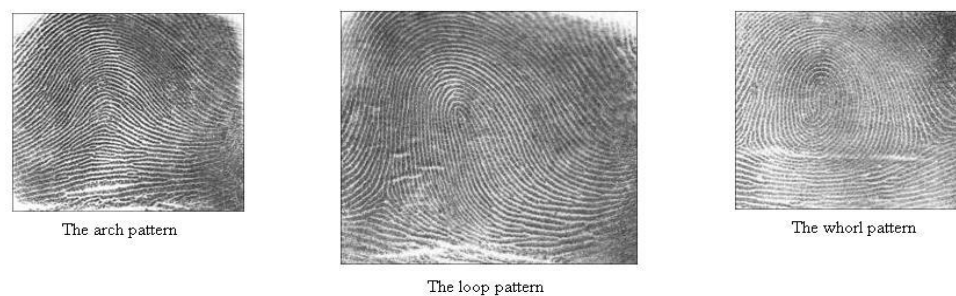
**Fig. (2) Expanded Feature Extractor Module from fig. (1)**

## 2- Background

The analysis of fingerprints for matching purposes generally requires the comparison of several of the print pattern. These including pattern, which are aggregated characteristics of ridges and minutia point which are unique features found with pattern <sup>[3]</sup>.

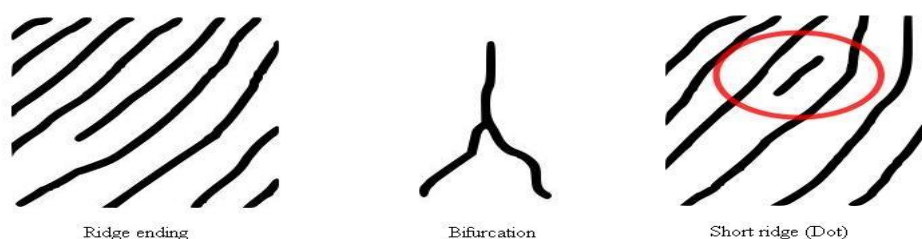
### 2-1 Fingerprint pattern

The three basic patterns of fingerprint ridges are arch, loop, and whorl. An arch is a pattern when the ridges enter from one side of the finger, rise in the centre forming an arch and then exit the other side of finger. The loop is a pattern, from a curve, and tends to exit from the same side of it enters. In the whorl pattern, ridges form circularly around a central point on the finger. Scientists have found that family members often have the same general fingerprint pattern. Leading to believe that these patterns are inherited Fig. (3) three basic pattern of fingerprints.



**Fig. (3) Basic pattern of fingerprints**

The major minutia features of fingerprint ridges are ridge ending , bifurcation, and short ridge (or dot). The ridge ending is the point at which a ridge terminates. Bifurcations are point at which a single ridge splits into two ridges. Short ridges (or dot) are ridges which are significantly shorter than the average ridge length on the fingerprint. Minutia and pattern are very important in the analysis of fingerprints since no two fingers have been shown to be identical. Fig. (4) shows the major minutia feature.



**Fig. (4) The major minutia features**

## 2-2 Discrete Fourier Transform <sup>[4]</sup>

The Discrete Fourier Transform is analogous to the continuous one and may be The FFT requires much fewer operations than the DFT (DFT requires  $N^2 \log_2 N$  operations). To find the FFT of an N point sequence is decomposed in even and odd terms as shown

$$X[K] = \sum_{m=0}^{\left(\frac{n}{2}\right)-1} x[2m] W_n^{2mk} + W_n^k \sum_{m=0}^{\left(\frac{n}{2}\right)-1} x[2m+1] W_n^{2mk} \dots\dots\dots (1)$$

using fact  $W_n^{(2m+1)} = \exp\left(-2j\pi\left(\frac{n}{2}\right)\right) = W_{\frac{n}{2}}$

Therefore,  $X[k] = X_{\frac{n}{2}}^{even}[k] + W_n^k X_{\frac{n}{2}}^{odd}[k] \dots\dots\dots (2)$

Where,

$$X_{\frac{n}{2}}^{even}[k]: \text{is the DFT } \{x[n]\}, n = 0, 2, \dots, n-2$$

$$X_{\frac{n}{2}}^{odd}[k]: \text{is the DFT } \{x[n]\}, n = 1, 3, \dots, n-1$$

In other words, the DFT of an N-points sequence  $X[n] = 0, 1, \dots, N-1$ , can be written as the combination of two DFTs of two N/2 point sequence  $X[2m]$  and  $X[2m+1]$ , with  $m=0, 1, \dots, (N/2) - 1$

Thus FFT may be represented diagrammatically by the butterfly structure. The correct order at the data sequence is obtained by reversing the binary representation of each index. The butterfly operator and the 8-point FFT are shown in Fig. (5).

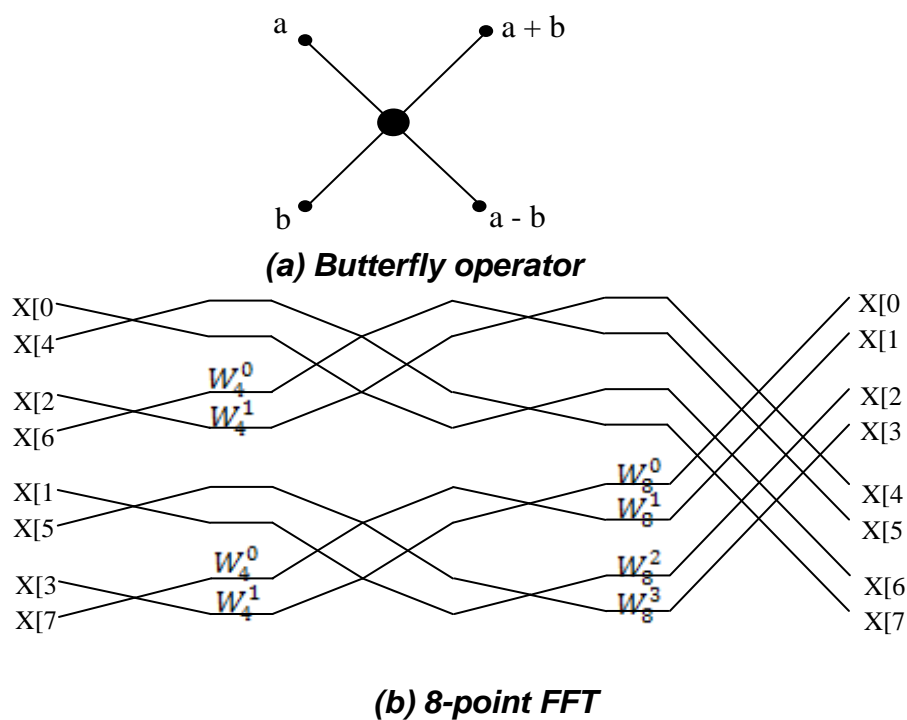
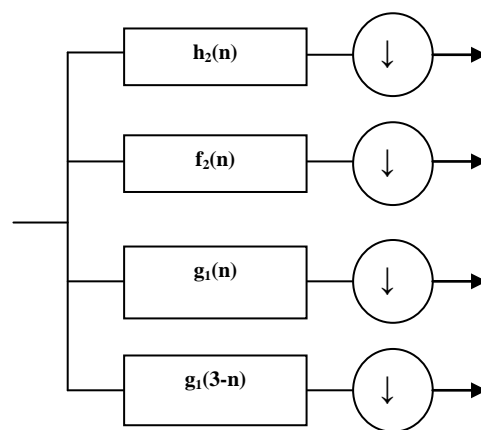


Fig. (5) Fast Fourier Transform

### 3-Slantlet Transform

The slantlet transform is an orthogonal discrete wavelet transform with two zero moment and with improved time localization. The construction of the slantlet is based on a filter bank structure where different filters are used at each scale. Fig. (6) show Two-scale filters bank using SLT it is occupied by different filters that are net products with this extra degree of freedom obtained by giving up the product form filter of shorter length are designated and satisfying orthogonality and zero moment condition <sup>[5]</sup> .

Some characteristic features at the slant filter bank are orthogonal, having Two zero moment and has octav-band characteristic. Each filter bank has a scale dilation factor of two and provides a multi resolution decomposition, the slantlet transform filter are piecewise linear, even though there is no true structure for slantlet it can be efficiently implemented like an iterated DWT filter bank. Therefore computation complexities of the slantlet are the same order are of the same order as the DWT, but slantlet transform gives better performance in de-noising and compression of the signals <sup>[6]</sup> .



**Fig. (6) Two – scale filter bank using SLT**

#### 3-1 Slantlet filter coefficients matrix

The filter that construct the slantlet filter bank are  $g_i(n)$ ,  $f_i(n)$  and  $h_i(n)$ , the scale filter bank has  $2L$  channel. The loop pass filter is to be called  $h_L(n)$ . The filter adjacent to the low-pass channel is called  $f$ . Both  $f_L(n)$   $h_L(n)$  and  $f_L(n)$  are followed by down sampling by  $2^L$ , the remaining  $2^L-2$  channel are filtered by  $g_i(n)$  and is shifted time reverse for  $i=1,2,\dots,L-1$  each is to be followed by down sampling by  $2^{i+1}$ . The sought filter  $g_i(n)$  is described four parameter [7] and can be written as.

$$g_i(n) \begin{cases} a_0 + a_1(n) \text{ for } n = 0, \dots, 2^i - 1 \\ b_0 + b_1(n - 2^i) \text{ for } n = 2^i, \dots, 2^{i+1} - 1 \end{cases} \quad (3)$$

The same approach for  $h_i(n)$  and  $f_i(n)$

$$h_i(n) \begin{cases} a_0 + a_1(n) \text{ for } n = 0, \dots, 2^i - 1 \\ b_0 + b_1(n - 2^i) \text{ for } n = 2^i, \dots, 2^{i+1} - 1 \end{cases} \quad (4)$$

$$f_i(n) \begin{cases} c_0 + c_1(n) \text{ for } n = 0, \dots, 2^i - 1 \\ d_0 + d_1(n - 2^i) \text{ for } n = 2^i, \dots, 2^{i+1} - 1 \end{cases} \quad (5)$$

To obtain  $g_i(n)$  such that sought L-scale filter bank is orthogonal with two zero moment requires parameters  $a_0, a_1, b_0$  &  $b_1$  such that

$$\begin{aligned} m &= 2^i \\ S_1 &= 6\sqrt{m / ((m^2 - 1)(4m^4 - 1))} \\ t_1 &= 2\sqrt{3 / (m * (m^2 - 1))} \\ S_0 &= S_1 * (m - 1) / 2 \\ t_0 &= \left( (m + 1) * \frac{S_1}{3} - m * t_1 \right) (m - 1) / (2m) \\ a_0 &= (S_0 + t_0) / 2 \\ b_0 &= (S_0 - t_0) / 2 \\ a_1 &= (S_1 + t_1) / 2 \\ b_1 &= (S_1 - t_1) / 2 \end{aligned}$$

The same approach work for  $h_i(n)$  and  $f_i(n)$

$$\begin{aligned} m &= 2^i \\ u &= 1 / \sqrt{m} \\ v &= \sqrt{(2m^2 + 1) / 3} \\ a_0 &= u * (v + 1) / (2m) \\ b_0 &= u * (2m - v - 1) / (2m) \\ a_1 &= u / m \\ b_1 &= -a_1 \\ q &= \sqrt{3 / (m * (m^2 - 1))} / m \\ c_1 &= -q * (v - m) \\ d_1 &= -q * (v + m) \\ d_0 &= d_1 * (v + 1 - 2 * m) / 2 \\ c_0 &= c_1 * (v + 1) / 2 \end{aligned}$$

The 2-D slantlet transform (2-D SLT) of a signal can be obtained performing 1-D slantlet of transform on the row follows by another slantlet transform to the columns.

The 2-D inverse slantlet transform of a signal can be found by applying (1-D SLT) on the row followed by another to the columns.

To generate a slantlet matrix [6] of size  $[2^L * 2^L]$  by using eq. (3), eq. (4) and eq. (5) , generate  $g_i(n)$   $h_i(n)$  and  $f_i(n)$ .

$$n = 1, 2, \dots, 2^L$$

$$T_{(1,n)} = h_L(n) + h_L(n + 2^L)$$

$$T_{(2,n)} = f_L(n) + f_L(n + 2^L)$$

$$i = L-1, \dots, 1$$

$$n = 1, \dots, 2^{i+1}$$

$$q = 2^{L-1} + 2 * (k^{2^{i+1}} - 1) + 1$$

$$T_{(q, n^{i+1} * (k-1))} = g_i(n)$$

$$T_{(q+1, n+2^{i+1} * (k-1))} = g_i(2^{i+1} + 1 - n)$$

The slantlet transform of input signal  $X_{(n)}$

$$y_{(k)} = \sum_{n=0}^{2^L-1} T_{(k,n)} X_{(n)} \dots \dots \dots (6)$$

The inverse slantlet transform can be computed as shown

$$X_{(n)} = \sum_{k=0}^{2^L-1} T_{(n,k)} y_{(k)} \dots \dots \dots (7)$$

Fig. (7) and Fig. (8) show 2-D slantlet transform and 2-D inverse slantlet transform

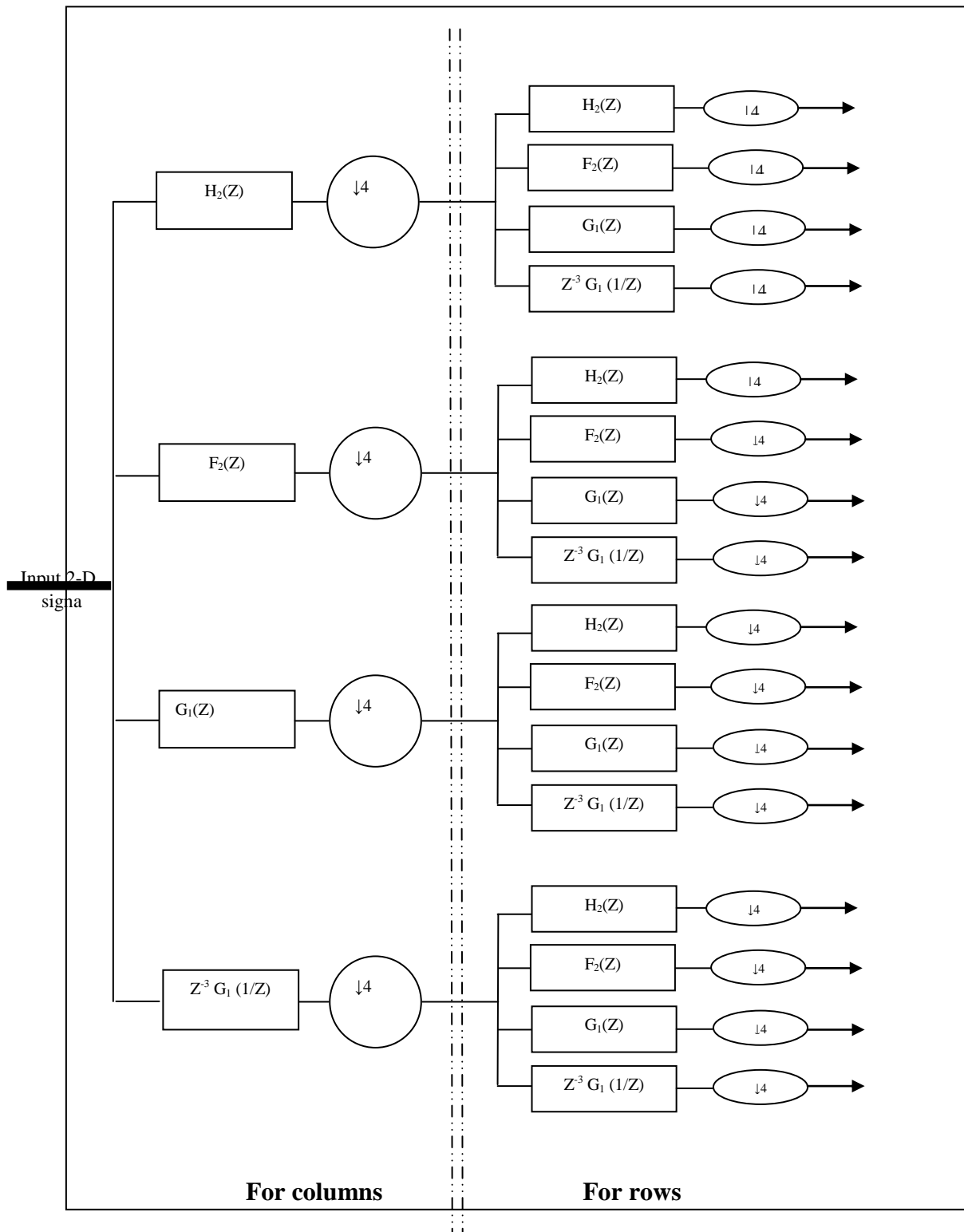


Fig. (7) scale-two, two dimension SLT



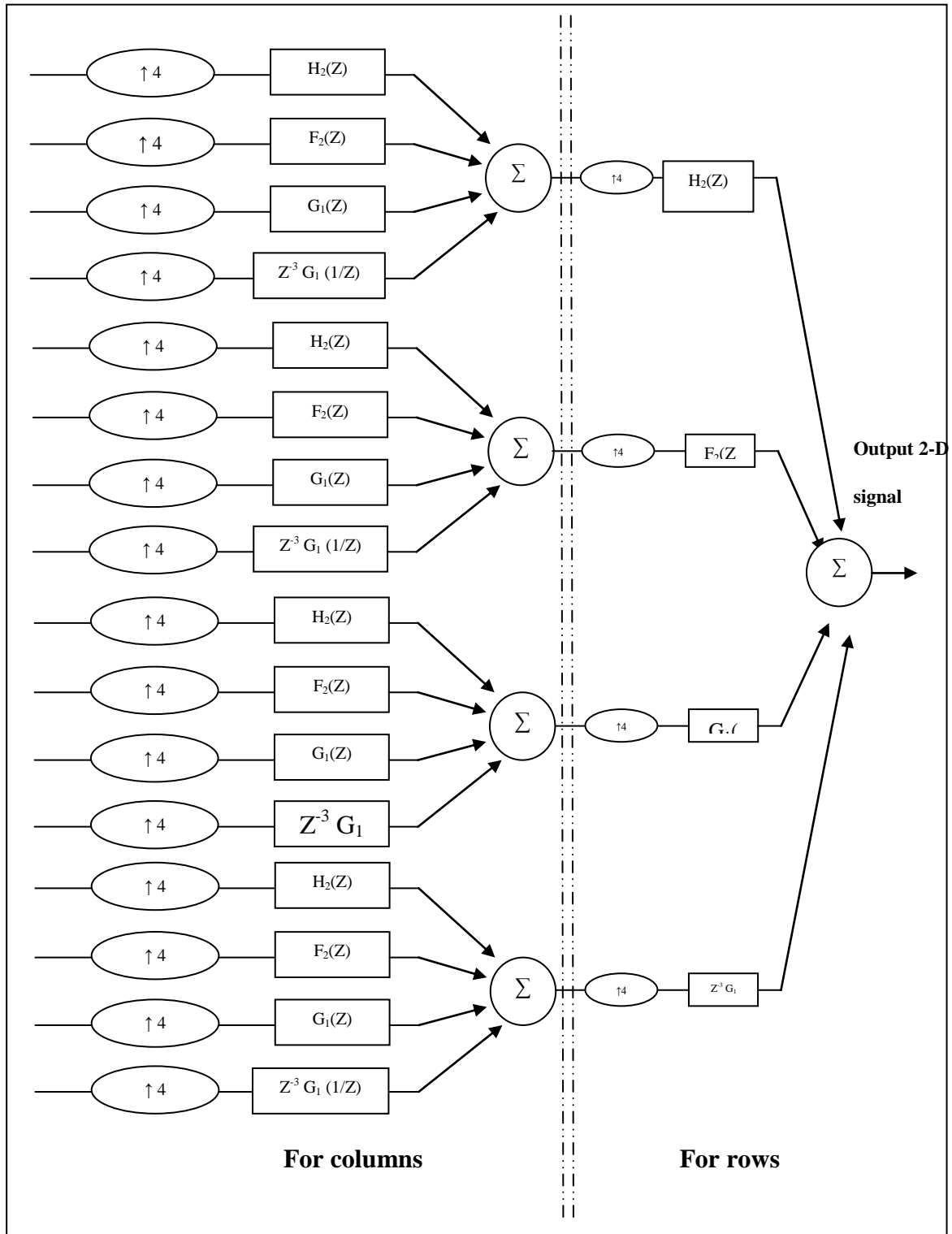
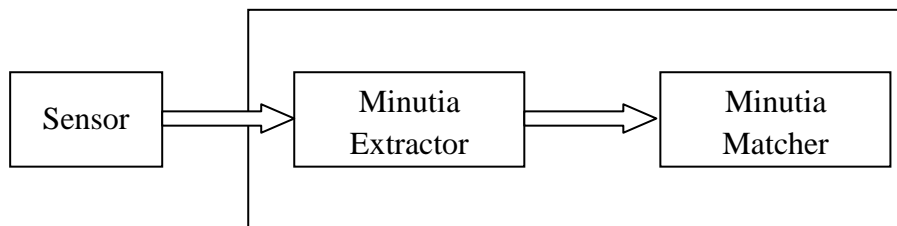


Fig. (8) scale-two, two dimension ISLT

### 4. Proposed Algorithm System

Fingerprint recognition system constitutes of a fingerprint acquiring devise, Minutia extractor and Minutia matcher as shown in Fig. (9)

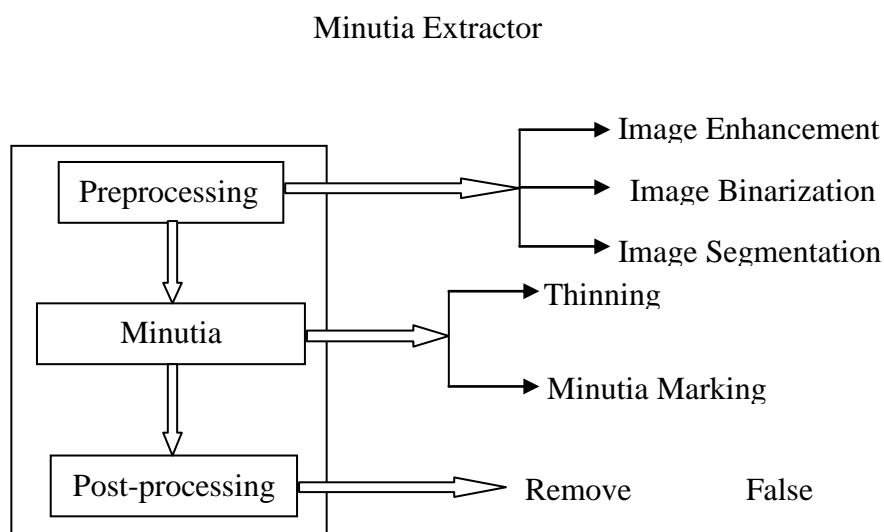


**Fig. (9) Simplified Fingerprint Recognition System**

For fingerprint acquisition, optical or semi-conduct sensors are widely used. They have high efficiency and acceptable accuracy expect from some case that user’s finger too dirty or dry. The database can be provided by FVC 2002 (fingerprint verify competition 2002). So no acquisition stage is implemented.

#### 4.1 inutia Extractor

Three-stage approach is widely used, preprocessing, minutia extractor and post-processing. Each stage will have many steps as shown in Fig. (10).



**Fig. (10) Minutia Extractor**

#### 4.2 Minutia Matcher

The minutia matcher chooses any two minutias as a reference minutia pair and then math their associate ridges first. If ridges match well, two fingerprint images are aligned and matching is conducted for all remaining minutia.

- Ridge Correction to Specify minutia pair
- Align two fingerprint images
- Minutia Match

**Fig. (11) Minutia Matcher**

## 5. Algorithm Level Design

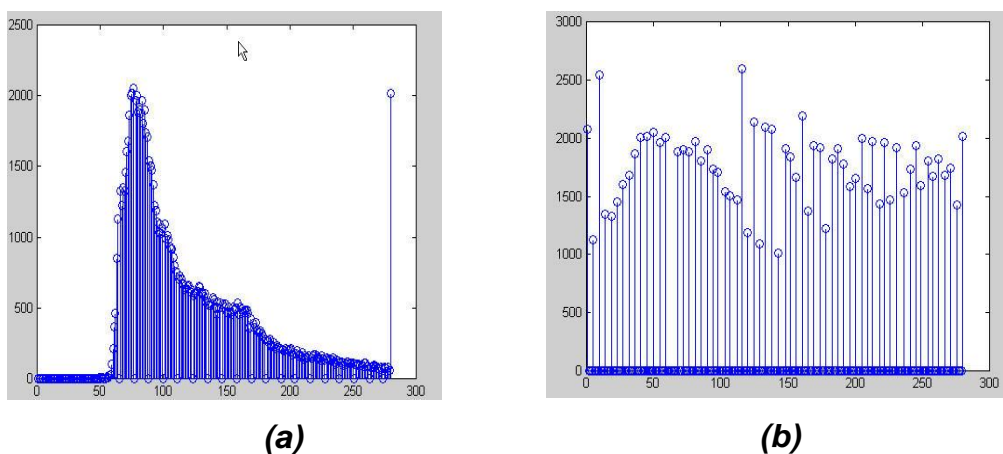
### 5.1 Minutia Extractor

#### Fingerprint Image Enhancement

Fingerprint images acquire from sensor or other Medias are not assured with perfect quality. Those enhancement methods, for increasing contract between ridges and furrow and for connecting the false broken point's ridges due to insufficient amount of ink, are very useful for keeping a higher accuracy to fingerprint recognition.

Histogram equalization is to expand the pixel value distribution of an image so as to increase the perceptual information. Histogram after histogram equalization occupies all the range from 0 to 255 and the visualization effect is enhanced.

Histogram is a graph showing the number of pixels in image at each different intensity value found in that image. For an 8-bit grayscale image there are 256 different positive intensities and then histogram will graphically display 256 number showing distribution of pixel amongst those grayscale values. Fig. (12) show the histogram and histogram equalization for one fingerprint.



**Fig. (12) fingerprint Image Enhancement:**  
**(a)The histogram of original image.**  
**(b)Histogram after histogram equalization.**

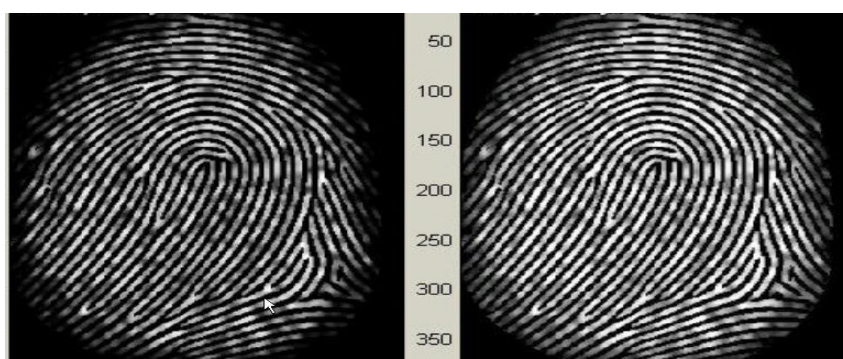
Histogram equalization has three stages:

- 1) Histogram Formation to see the article on histogram.
- 2) New Intensity values calculation for each intensity levels by the equation

$$O_i = \left[ \sum_{j=0}^i N_j \right] * \frac{\text{maximum intensity level}}{\text{Number of pixels}}$$

Max. intensity levels mean max. intensity levels which a pixel can get, example for image in grayscale domain, then the count 255 and the image of size [256 \* 256] then, the number of pixels 65536. Calculating the output intensity level for 255 input intensity level, mean that number of pixels in the image having the intensity below 255 means 0, 1, 2, ....., 255.

- 3) Replace the previous intensity values with the new intensity values. This is accomplished by putting the value of  $O_i$  in the image for all the pixels,  $O_i$  represent the new intensity value, whereas  $i$  represent the previous level. Fig. (13) represent Histogram Enhancement.

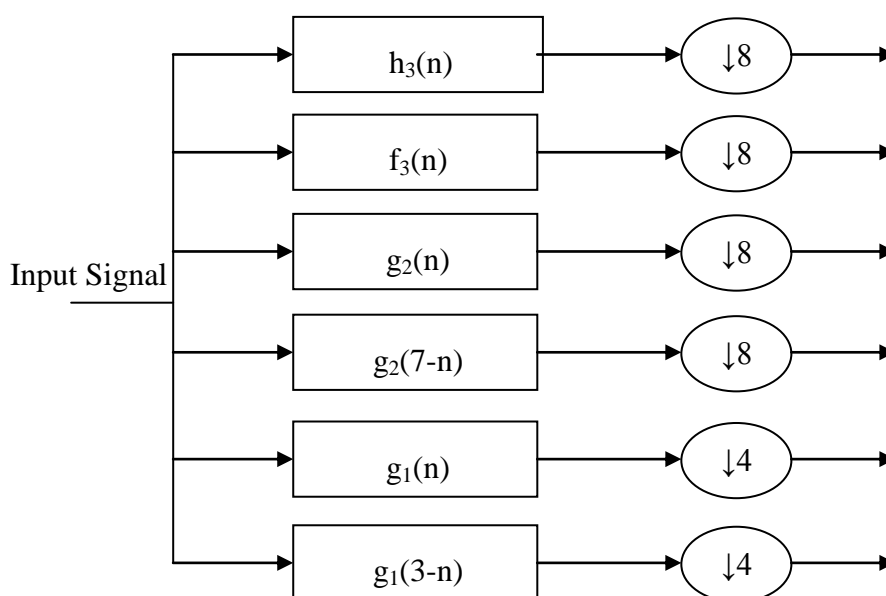


(a) (b)  
**Fig. (13) Histogram Enhancement**

- a) Original Image
- b) Enhanced Image

### 5.2.1 Fingerprint Enhancement by slantlet transform

The slantlet transform was found using the 3-scale filter bank; this structure will be obtained by using 6 different filters and the result of using this transformation on the extracted fingerprint (256 sample for each segment) will be different sub bands ( $a_1, d_1, d_2, d_3, d_4, d_5$ ). As shown in Fig. (14) .



**Fig. (14) 3-scale slantlet filterbank**

- a1: is 32 samples which are the outputs of the low pass filter  $h_3$  after down sampling by 8. Only this vector will be used as the features of the fingerprint.
- d1: is 32 samples which are the outputs of the band pass filter  $f_3$  after down sampling by 8.
- d2: is 32 samples which are the outputs of the band pass filter  $g_2$  after down sampling by 8.
- d3: is 32 samples which are the outputs of the band pass filter (shifted time reverse of  $g_2$ ) after down sampling by 8.
- d4: is 64 samples which are the outputs of the band pass filter  $g_1$  after down sampling by 4.
- d5: is 64 samples which are the outputs of the band pass filter (shifted time reverse of  $g_1$ ) after down sampling by 4.

a1 only this vector will be used as the features of the fingerprint. Fig. (15) show fingerprint enhancement by SLT. Then reconstruction fingerprint from its feature (a1) only by using inverse SLT transform. The enhanced image by SLT has improvement to connect some falsely broken points on ridges and to remove some spurious connections between ridges. The shown image in Fig (15) is also processed with histogram equalization after SLT transform. Taking ISLT and treated fingerprint image resulted as the original image.

**5.2.2 Fingerprint Enhancement by Fourier Transform**

Fingerprint image will be divided to small processing blocks (32 by 32 pixels) and perform FT according to

$$F_{(u,v)} = \sum_{x=0}^{M-1} \sum_{y=0}^{N-1} f_{(x,y)} + \exp \left\{ -2j\pi * \left\{ \left( \frac{uv}{M} = \frac{vy}{N} \right) \right\} \right\} \dots \dots \dots (8)$$

In order to a special block by its dominant frequencies,

$$FFT = abs (F_{(u,v)}) = \left| F_{(u,v)} \right|$$

Get enhanced block according to

$$g_{(x,y)} = F^{-1} \left\{ F_{(u,v)} * \left| F_{(u,v)} \right|^k \right\} \dots \dots \dots (9)$$

Where  $F^{-1}(F_{(u,v)})$  is done by:

$$F_{(x,y)} = \frac{1}{MN} \sum_{x=0}^{M-1} \sum_{y=0}^{N-1} f_{(u,v)} * \exp \left\{ 2j\pi * \left\{ \left( \frac{ux}{M} = \frac{vy}{N} \right) \right\} \right\} \dots \dots \dots (10)$$

For  $x = 0, 1, 2, \dots, \dots, 31$  and  $y = 0, 1, 2, \dots, \dots, 31$

The FFT is transformation of the signal from time domain to frequency domain means no information about time is available in the transformed signal. The FFT transform of a signal is complex number, means amplitude and phase information are available, this will make taking the amplitude alone not enough to give required result. The SLT is a transformation to the time-frequency domain but better time localization is obtained SLT as the orthogonal transform for features extraction is the more accurate system for the recognition system.

### 5.3 Fingerprint Image Binarization

Fingerprint Image Binarization to transform the 8-bit fingerprint image to 1-bit image with 0-value for ridges and 1-value for furrows. So that ridges in the fingerprint are highlighter with black color while furrows are white. Locally adaptive Binarization method is performed to binarize the fingerprint image. This is the mechanism of transforming a pixel value to 1 if the value is larger than the mean intensity value of the current block (16\*16) to which pixel belongs to. Fig. (16) represents fingerprint after adaptive Binarization.

### 5.4 Fingerprint Image Segmentation

A region of interest (ROI) is useful to be recognized for each fingerprint image. The image area without effective ridges and furrows is first discarded since it only folds background information. To extract the ROI, two-step is used.

- 1) Block direction estimation & direction check.
- 2) Morphological Operation.

#### 5.4.1 Block Direction Estimation

First, estimate the block direction for each block of the fingerprint image with (16\*16) pixel, by the algorithm

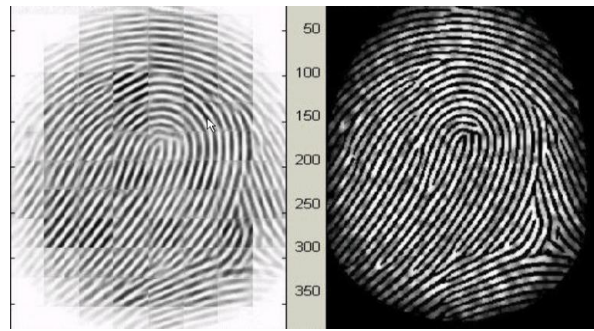
- I. Calculating the gradient values along X-direction ( $g_{(x)}$ ) and Y-direction ( $g_{(y)}$ ) for each pixel block. Two shoal filters are used to fulfill the calculation.
- II. For each block, the formula below is used to get least square approximation of the block direction.

$$tg_2 B = 2 \sum \sum (g_x * g_x) / \sum \sum (g_x^2 - g_y^2)$$

For all pixels in each block. So the value of the tangent value block direction is estimated nearly the same way illustrated by the formula:  
 $tg_2 \theta = 2 \sin \theta \cos \theta / (\cos^2 \theta - \sin^2 \theta)$

- III. After estimation of each block direction, blocks without significant information or ridges and furrows are discarded based on the following formula:

$$E = \{2 \sum \sum (g_x * g_y) + \sum \sum (g_x^2 - g_y^2)\} / W * \sum \sum (g_x^2 + g_y^2)$$



(a) (b)

Fig. (15) show the direction map of fingerprint  
(a) Enhancement image using SLT  
(b) Original image using ISLT

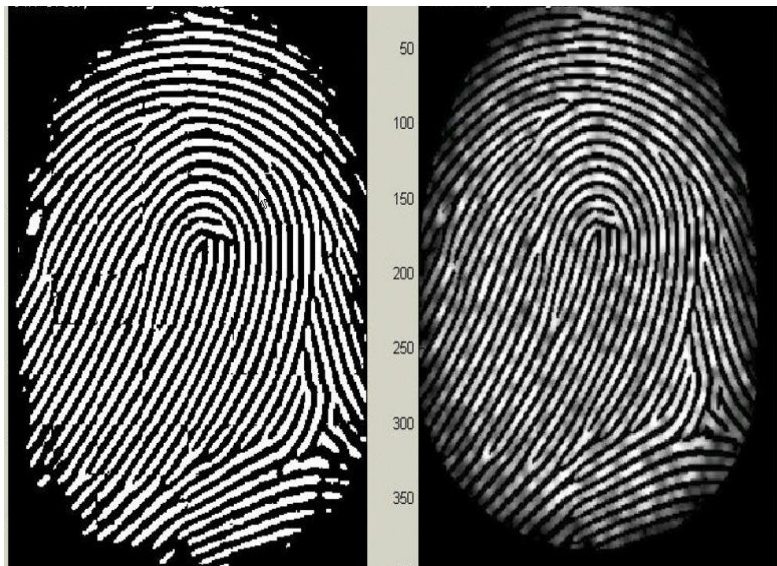


Fig. (16) Binarization Image

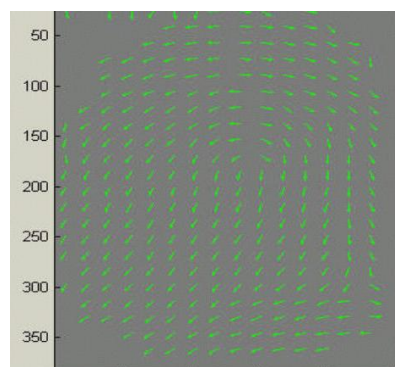
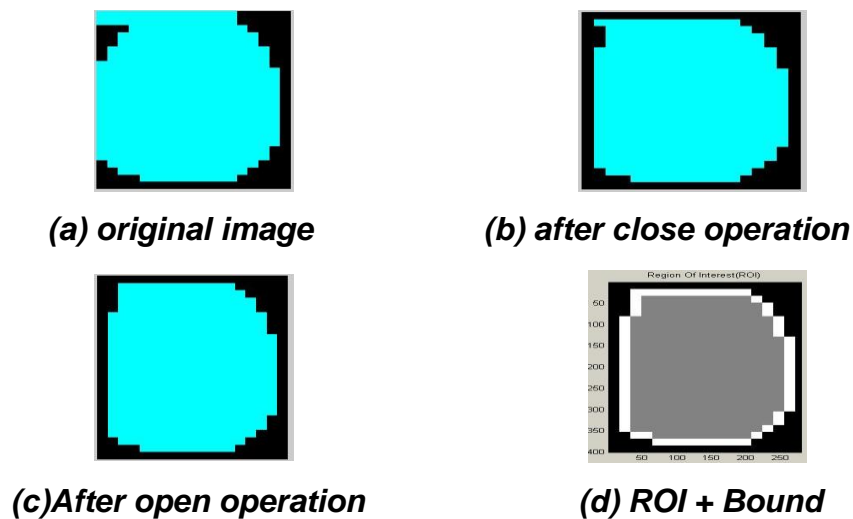


Fig. (17) shows the direction map of fingerprint

### 5.4.2 ROI by Morphological Operations

Two morphological operation called ‘OPEN’ and ‘CLOSE’ are adopted. The ‘OPEN’ operation can expand images and remove peak introduction by background noise. The ‘CLOSE’ operation can shrink images eliminate small cavities. Fig. (17).



**Fig. (18) show the OPEN & CLOSE operation.**

The bound is the subtraction of the closed area from the opened area. Then the algorithm throws away those leftmost, rightmost, uppermost and bottommost blocks out of the bounds so as to get the lightly bounded version just containing the bound and inner area.

### 5.5 Fingerprint Ridge Thinning

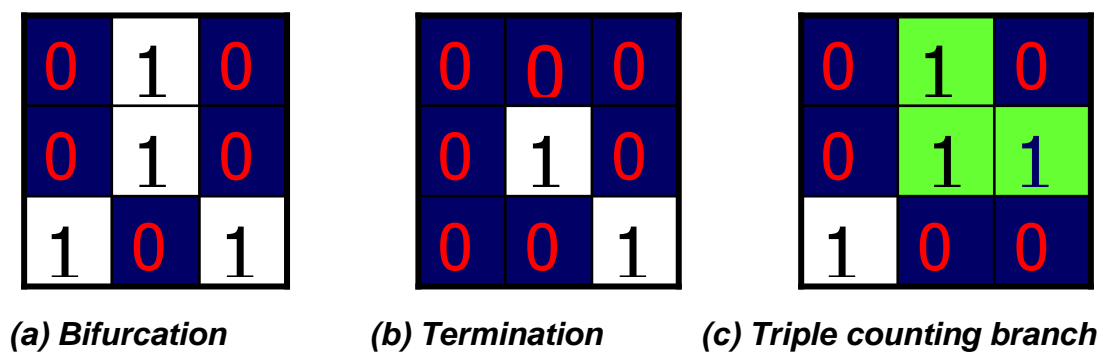
The purpose of thinning is to preserve the fingerprint minutia shape while elimination the extra information, which is noise. After applying the thinning filters the skeletal remains of the curves, only one pixel wide, are left. There are four main conditions dictating which pixel can be neglected. The neighbor of a pixel W is defined as 3\*3 pixel area surrounding pixel. Thinning is accomplished by using an interactive algorithm to turn off pixels by checking the neighborhood of pixel in questioned and verifying that the four conditions are met. The first condition eliminates the possibility of negating an isolated pixel or one that is completely surrounded. The second makes sure that the object being thinning does not get shorter. The third and fourth conditions guarantee the algorithm does not disconnect skeletal segment within objects. These conditions all ensure that the sample is properly thinned without losing valuable information.

### 5.6 Minutia Marking

For each 3\*3 window, if the central pixel is 1 and has exactly 3 one-value neighbors, then the central pixel is a ridge branch Fig. (19a) shows that, if central pixel is 1 and has only 1 one-value neighbor, then the central pixel is a ridge ending. Fig. (19b) represents that. Fig. (19c) illustrates a special case that a genuine branch is triple counted, suppose the uppermost pixel with value 1 and rightmost pixel with value 1 have another neighbor outside 3\*3 window, so the two pixel will be marked as branches too.



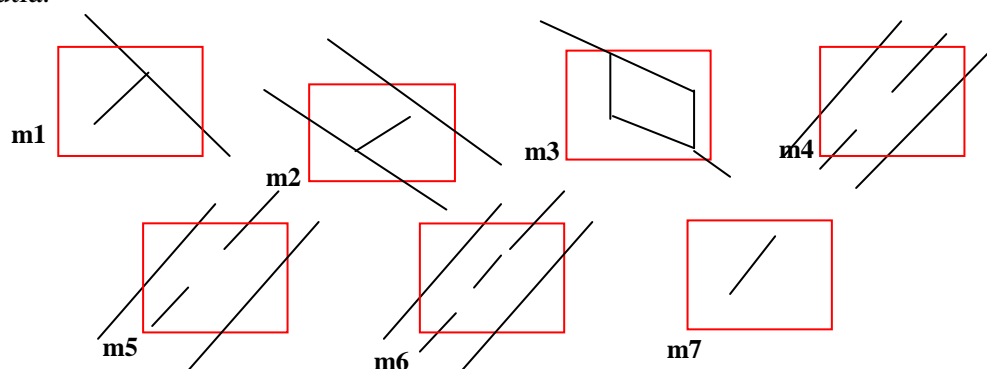
So check routine requiring that none of the neighbors of a branch are branches is added. Also the average inter-ridge width  $D$  is estimated at their stage. The average inter-ridge width refers to the average distance between two neighboring ridges;  $D$  can be approximate by scan a row of the thinning ridges, image and sum up all pixels in the row whose value is one. Then divided the row length with above summation get inter-ridge width together with the minutia marking, all thinned ridges in the fingerprint image are labeled



**Fig. (19) Minutia Marking**  
**(a) Bifurcation**  
**(b) Termination**  
**(c) Triple counting branch**

### 5.7 False Minutia Removal

False ridge breaks due to insufficient amount of ink and ridge cross-connections due to over inking are not totally eliminated. These false minutias will significantly affect the accuracy of matching if they are simply regarded as genuine minutia. Fingerprint verification system keeps essential mechanism to remove false minutia. Fig. (20) shows the types of false minutia.



**Fig. (20) False minutia structures.**

The procedure of removing false minutia is:

1. If the distance between one bifurcation and one termination is less than  $D$  and the two minutias are ridge (m1 case) remove both of them.
2. If the distance between two bifurcations is less than  $D$  and they are in the same ridge, remove the two bifurcations, (m2 and m3 cases).

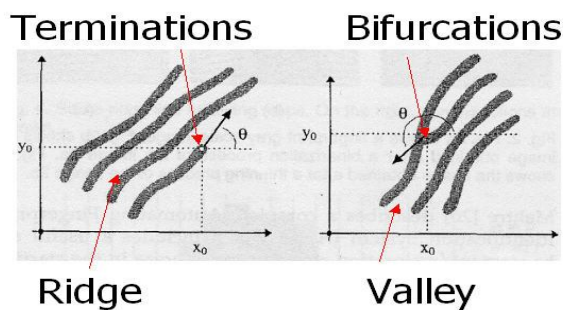
3. If two terminations are within a distance  $D$  and their directions are coincident with a small angle variation. And they suffice the condition that no any other termination is located between the two terminations. Then the two terminations are regarded as false minutia derived from a broken ridge and are removed, (m4, m5, and m6 cases).
4. If two terminations are located in a short ridge with length less than  $D$ , remove the two terminations (m7 case). Where  $D$  is the average inter-ridge width representing the average distance between two parallel neighboring ridges.

**5.8 Unify terminations and bifurcations.**

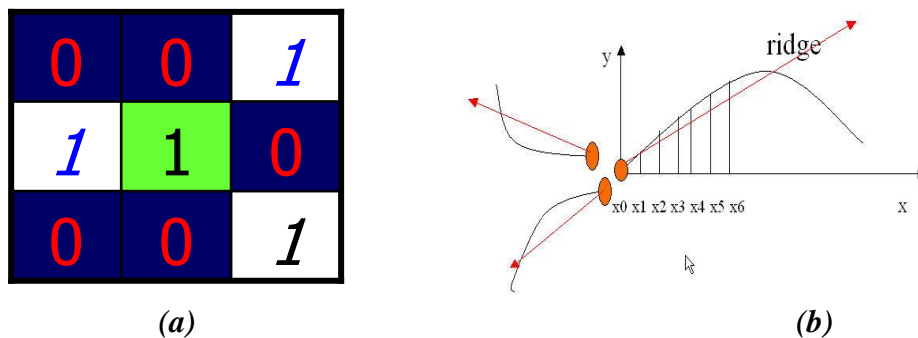
Since various data acquisition such as impression pressure can easily change one type of minutia into the other. The unification representation for both termination and bifurcation. So each minutia is completely characterized by the following parameters at least:

1. X-Coordinate.
2. Y- Coordinate.
3. Orientation.

The orientation calculation for a bifurcation needs to be specially considered. All three ridges driving from the bifurcation point have their own direction. Representation for the bifurcation orientation is shown in Fig. (21). Simply chooses the minimum angle among the three anticlockwise orientations starting from the X-axis, both methods cast the other direction away. So some information will be lost. A noval representation to break a bifurcation into three terminations. The new three terminations are the three neighbors pixels at the bifurcation and each of the ridges connected to bifurcation before, is now associated with a termination respectively as shown in Fig. (22)



**Fig. (21) Minutia. (Valley is also referred as Furrow, Termination is also called Ending, and Bifurcation is also called Branch)**



**(a) Three neighbors become terminated**  
**(b) Each termination has their own orientation**

And the orientation of each termination (tx,ty).Track a ridge segment whose starting point is the termination and length is D. Sum up all x-coordinates of points in the ridge segment. Divide above summation with D to get sx. Then get sy using the same way. Get the direction from:  $a \tan((sy - ty)/(sx - tx))$ .

## **6- Minutia Match**

Given two set of minutia of two fingerprint images, the minutia match algorithm determines whether the two minutia sets are from the same finger or not. An alignment-based match algorithm includes two consecutive stages:

- 1) Alignment stage.
- 2) Match stage

### **6.1 Alignment Stage**

Given two fingerprint images to be matched, choose any one minutia from each image; calculate the similarity of the two ridges associated with the two referenced minutia points. If the similarity is larger than a threshold, transform each set of minutia to a new coordination system whose origin is at the referenced point and whose x-axis is coincident with the direction of the referenced point.

### **6.2 Matcher state**

After getting two set of transformed minutia points, using the elastic match algorithm to count the matched minutia pairs by assuming two minutias having nearly the same position and direction are identical.

## **7- Implementation**

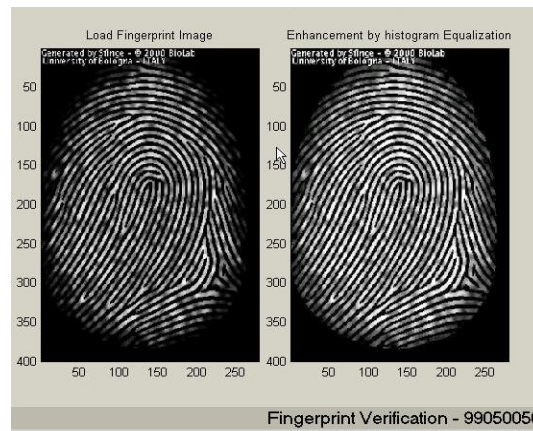
The data contains different fingerprint of different person each person have only one fingerprint. All fingerprints tries to have the amount of ink and angle rotation. Fingerprint database are in gray level and the image size is the same. In this proposed system, fingerprint are taken from some entity that gave to provide fingerprint for officers and asked not to mention to it. So that sensor are not used in this proposed. If natural fingerprint is taken, there are many problems can be faced, such that more or poor amount of ink, some person has injury in his fingers, all these will affect the accuracy of matching result. The matching ration for the result is to 100; . Implementation of this technique is done by the MATLAB 2008<sup>®</sup>. The main MATLAB 2008<sup>®</sup> functions that are used in the work: Figure, area, ui control, imread, double, FFT, im show, esc fspecial ('average', 'sobel') filter 2 bw label, bw morph ('open', 'close', 'hbreak'). SLT function not built in Funct.

### **7-1 SLT created to minutia feature extractor**

Many steps are implemented in the work:-

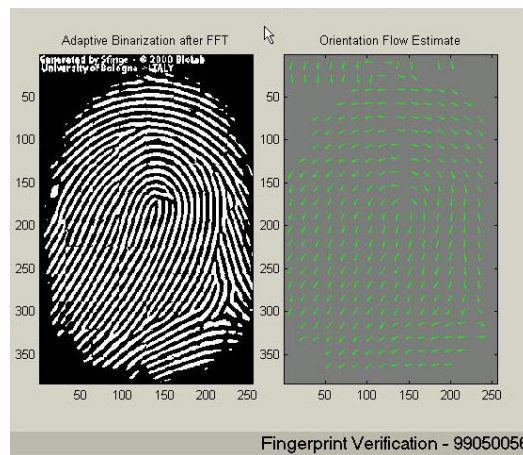
1. Load a gray Level fingerprint image, fingerprint ridges should have large gray intensity comparing with the back ground and valleys. Fig. (15) fingerprint are taken to implement.

2. Histogram Equalization are implemented and Figure below show the original fingerprint and enhanced image.
3. SLT is applied instead of FFT. SLT is used to extractor the feature of the Histogram Equalization image of fingerprint, with scale 3, Filter bank. Fig. (23) Fig. (15).

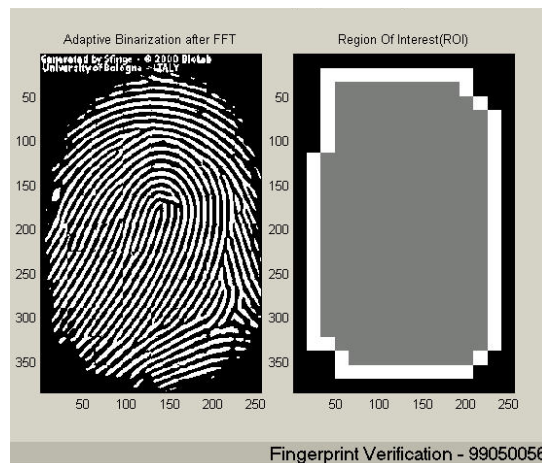


**Fig. (23) Histogram Equalization**

4. Binarization form from the image result above (step3) and also binarization and block direction map see Fig. (2) below, Fig. (25) represent Region of interest ROI.

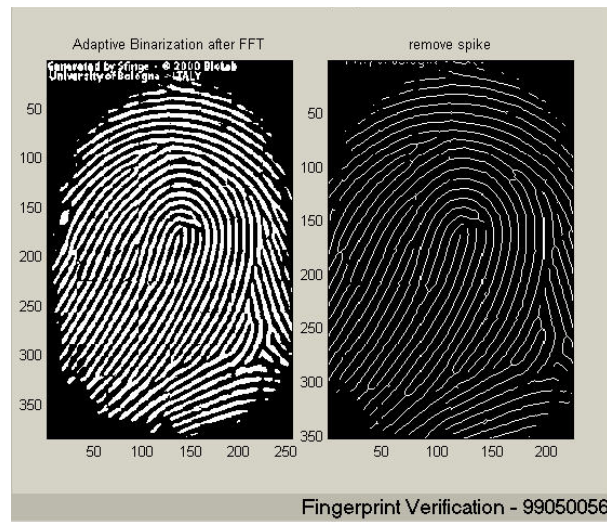


**Fig. (24) Fingerprint Image**



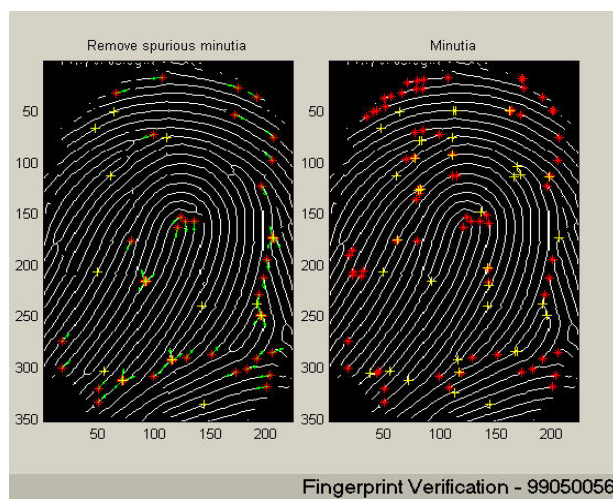
**Fig. (25) ROI extraction**

5. Thinning and Removal H breaks. First fingerprint image and then H breaks removal, isolated peaks removal and spike removal as seen in Fig (26 ).



**Fig. (26) Remove spike**

6. Extract and Real Minutia. Minutia marking and false Minutia removal. Bifurcation are located with red stars. And the genuine minutia are labeled with orientations. All that are shown in the last Fig. (27).



**Fig. (27)**

7. Finally, saving the minutia to a text file. The saved text file stores the information on all genuine minutias.

**7-2 Code Test:**

The following table represents the results of matching between 10 finger prints .

<b>fingerprint</b>	<b>fingerprint</b>	<b>match ratio</b>
<b>1</b>	<b>1</b>	<b>100</b>
<b>1</b>	<b>2</b>	<b>0</b>
<b>1</b>	<b>3</b>	<b>0</b>
<b>1</b>	<b>4</b>	<b>2.2472</b>
<b>1</b>	<b>5</b>	<b>0</b>
<b>1</b>	<b>6</b>	<b>0</b>
<b>1</b>	<b>7</b>	<b>0</b>
<b>1</b>	<b>8</b>	<b>0</b>
<b>1</b>	<b>9</b>	<b>0</b>
<b>1</b>	<b>10</b>	<b>86.5169</b>

<b>fingerprint</b>	<b>fingerprint</b>	<b>Match ratio</b>
<b>2</b>	<b>2</b>	<b>100</b>
<b>2</b>	<b>3</b>	<b>9.5238</b>
<b>2</b>	<b>4</b>	<b>0</b>
<b>2</b>	<b>5</b>	<b>49.7354</b>
<b>2</b>	<b>6</b>	<b>0</b>
<b>2</b>	<b>7</b>	<b>0.2646</b>
<b>2</b>	<b>8</b>	<b>0</b>
<b>2</b>	<b>9</b>	<b>0</b>
<b>2</b>	<b>10</b>	<b>0</b>

<b>fingerprint</b>	<b>fingerprint</b>	<b>Match ratio</b>
<b>3</b>	<b>3</b>	<b>100</b>
<b>3</b>	<b>4</b>	<b>0</b>
<b>3</b>	<b>5</b>	<b>0.5618</b>
<b>3</b>	<b>6</b>	<b>25.8427</b>
<b>3</b>	<b>7</b>	<b>1.1236</b>
<b>3</b>	<b>8</b>	<b>2.5281</b>
<b>3</b>	<b>9</b>	<b>1.4045</b>
<b>3</b>	<b>10</b>	<b>0</b>

<b>fingerprint</b>	<b>fingerprint</b>	<b>Match ratio</b>
<b>4</b>	<b>4</b>	<b>100</b>
<b>4</b>	<b>5</b>	<b>0.885</b>
<b>4</b>	<b>6</b>	<b>0</b>
<b>4</b>	<b>7</b>	<b>0</b>
<b>4</b>	<b>8</b>	<b>0</b>
<b>4</b>	<b>9</b>	<b>89.521</b>
<b>4</b>	<b>10</b>	<b>0</b>

<b>fingerprint</b>	<b>fingerprint</b>	<b>Match ratio</b>
<b>5</b>	<b>5</b>	<b>100</b>
<b>5</b>	<b>6</b>	<b>0</b>
<b>5</b>	<b>7</b>	<b>0</b>
<b>5</b>	<b>8</b>	<b>0</b>
<b>5</b>	<b>9</b>	<b>0</b>
<b>5</b>	<b>10</b>	<b>0</b>

<b>fingerprint</b>	<b>fingerprint</b>	<b>Match ratio</b>
<b>6</b>	<b>6</b>	<b>100</b>
<b>6</b>	<b>7</b>	<b>0</b>
<b>6</b>	<b>8</b>	<b>0</b>
<b>6</b>	<b>9</b>	<b>0</b>
<b>6</b>	<b>10</b>	<b>0.6579</b>

<b>fingerprint</b>	<b>fingerprint</b>	<b>Match ratio</b>
<b>7</b>	<b>7</b>	<b>100</b>
<b>7</b>	<b>8</b>	<b>35.2941</b>
<b>7</b>	<b>9</b>	<b>0</b>
<b>7</b>	<b>10</b>	<b>0</b>

<b>fingerprint</b>	<b>fingerprint</b>	<b>Match ratio</b>
<b>8</b>	<b>8</b>	<b>100</b>
<b>8</b>	<b>9</b>	<b>0</b>
<b>8</b>	<b>10</b>	<b>0</b>

<b>fingerprint</b>	<b>fingerprint</b>	<b>Match ratio</b>
<b>9</b>	<b>9</b>	<b>100</b>
<b>9</b>	<b>10</b>	<b>0</b>

<b>fingerprint</b>	<b>fingerprint</b>	<b>Match ratio</b>
<b>10</b>	<b>10</b>	<b>100</b>

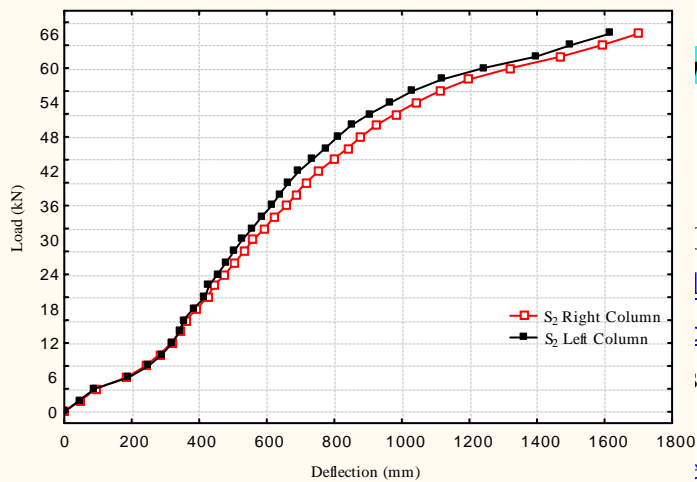


## 8- Conclusion

Although automated fingerprint identification system comes in various forms, there are fundamental parts that remain the same. SLT is vital in enhancing the quality of a fingerprint. After this enhancement is applied and the image becomes distinct, the print is further thinned. Recognition works best on thinned image, because recognition on program has sufficiently limited the domain of its parameters. Once features are extracted and stored with relevant information. The extracted features are later used to compare a new fingerprint with a set of enrolled fingerprints already stored in a data base. If the recognized features match, the new fingerprint can be identified and associated with an individual.

The following issues can be concluded from the methods applied for the fingerprint recognition:

1. For finding enhanced feature at the fingerprint image several methods can be used such as FFT. In the proposed features are founded using SLT, so that dimensionality reduction in this transformation method will reduce the computational efforts to find the feature extractor.
2. The transform of image to another domain will be done on all the sample of the image this means all the information about image are taken in consideration unlike other methods that were applied to choose only some information.
3. The transformation of the signal can be done from time domain to time-frequency domain this gives better results than transformation to frequency domain only such as in FFT.
4. The SLT is an orthogonal transform provides improve time localization than FFT therefore it will improve the recognition results.
5. The ridge ID used to distinguish minutia and the seven types of false minutia are strictly defined comparing with those loosely defined by the often methods.
6. The procedures of removal is well considered to reduce the computation complexity.
7. It is the best way to recognize a person, because no one can take, borrow or steal a fingerprint from another person to use it. Compare with any purpose as that may occur with ID card password.
8. It is fast and simple way to identify any person. So that many entities in country use this way. Also according to the worst conditions were passed through it, it is best to take fingerprint of all people in the country and check it in any time to avoid problems that may occur.



(2005, November 1). Fingerprint identification, 06, from

[labs/projectv1.1.pdf](#)

[ja/node41.html](#). Nanavati, S., Thieme, M., & : identity verification in a networked world. New

[ingerprint\\_recognition](#), endnote-jain.

4. B.W. jervis and E.c. If eachor, “ Digital Signal Processing, a Practical Approach”; Second edition, 2002.
5. G.Panad. P.K. Dash, A.K. and s.k. Meher, “ Data Compression of Power Quality Events Using The Slantlet Transform”. IEEE. Transaction on power Delivery, vol.17.2, April 2002.
6. I.w. Selesenick. “ DISCRETE WAVELET TRANSFORM OF APPROXIMATION ORDER 2, WITH IMPROVED TIME LOCALIZATION- THE SLANTLET TRANSFORM polytechnic. University-Electrical Engineering- G Metrotech Centre Brooklyn, NY//201-3840, 1998.
7. Mommed Hazim Abdul-Kareem “ optimum Technique For Data File Denoising” M. sc. The University of Baghdad, Collage of Engineering. Electrical Eng. Dept. 2007.