

Degradation of Dazomet by Thermal Fenton and Photo-Fenton Processes under UV and Sun lights at Different Temperatures

Eman A. Mohammed

Souad A. Mousa*

Received 4/3/2018, Accepted 16/5/2018, Published 3/6/2018



This work is licensed under a [Creative Commons Attribution 4.0 International License](https://creativecommons.org/licenses/by/4.0/).

Abstract:

In this research, the degradation of Dazomet has been studied by using thermal Fenton process and photo-Fenton processes under UV and lights sun. The optimum values of amounts of the Fenton reagents have been determined (0.07g FeSO₄ .7H₂O, 3.5μl H₂O₂) at 25 °C and at pH 7 where the degradation percentages of Dazomet were recorded high. It has been found that solar photo Fenton process was more effective in degradation of Dazomet than photo-Fenton under UV-light and thermal Fenton processes, the percentage of degradation of Dazomet by photo-Fenton under sun light are 88% and 100% at 249 nm and 281 nm respectively, while the percentages of degradation for photo-Fenton under UV-light are 87%, 96% and for thermal Fenton are 70% and 66.8% at 249 nm and 281 nm respectively. In this research the effect of temperature on all the reactions has been studied in the range 25°C-45°C, it has been noticed that the reaction rate constant (k) has increased with increasing temperature, and the best percentage degradation of Dazomet was at 45°C in all processes, so, the thermodynamic functions ΔG*, ΔH*, ΔS* have been calculated.

Keywords: Fenton processes, Dazomet degradation, photocatalysts, Photodegradation of Pesticides.

Introduction:

Dazomet (tetrahydro-3,5-dimethyl-1,3,5-thiadiazine-2-tione) (IUPAC) is a soil fumigant. It is also known as tetrahydro-3,5-dimethyl-2H-1,3,5-thiadiazine-2-thione (1), Fig.1.

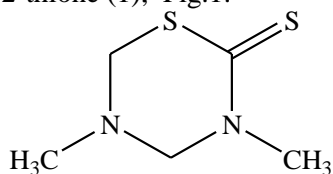

Figure 1. Structure of Dazomet

Many researchers have studied the properties of Dazomet and its degradation in various methods such as UV-visible spectroscopy, high-performance liquid chromatography (HPLC), gas chromatography-mass spectrometry (GC-MS), and fast atom bombardment-mass spectrometry (FAB-MS) (2-12). In this work Dazomet pesticide has been used to study its degradation using Fenton processes (13). It is suggested that the Fe⁺² / Fe⁺³ catalysts are able to promote hydrogen peroxide decomposition leading to the formation of hydroxyl radicals, which are highly reactive with a wide range of organic pollutants (14, 15).

Department of Chemistry, College of Science for Woman, University of Baghdad, Baghdad, Iraq.

*Corresponding author: souadabdmousa@yahoo.com

By the following sets of reactions, the possible mechanism of Fenton reaction may be understood: (16, 17)

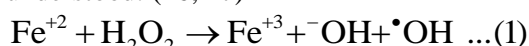

In the absence of organics and in the presence of excess H₂O₂, the OH[•] will react with H₂O₂ to form superoxide.

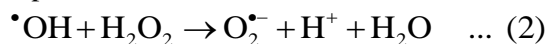

Originally, the superoxide was thought to react with hydrogen peroxide, this reaction is commonly known as the Haber Weiss reaction

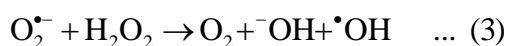

Later studies by Barb et al (1951) and Rush and Bielski (1985) have shown unequivocally that equation 1 does not take place as written, because of the very low rate constant of the reaction. Instead, superoxide reduces Fe⁺³ rather than H₂O₂:

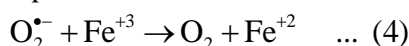

Therefore, the overall reaction is seen as a decomposition of H₂O₂ as the following equation

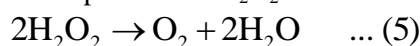

The photo-Fenton processes consist of in the combination of ferrous ions (Fe⁺²), hydrogen peroxide (H₂O₂), and UV irradiation (18, 19). The photo-Fenton process can be divided into the following steps; the first stage is the so-called Fenton reaction, in which ferrous ions (Fe⁺²) are

oxidized to ferric ions (Fe^{+3}), giving rise to hydroxyl radicals (HO^\bullet) as shown in eq.1

The ferric ions, represented by the complex $[\text{Fe}(\text{OH})]^{+2}$, is reduced back to Fe^{+2} by absorption UV irradiation, according to following equation

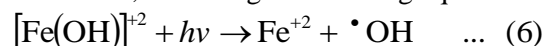

The generated hydroxyl radicals can degrade organic pollutants (RH) present in aqueous solutions. Parameters such as pH and reagent concentration ratios must be controlled, in order to enhance the efficiency of the degradation process, as shown in the following equation (2, 3)

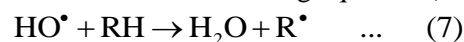

Hydrogen peroxide concentration plays a more crucial role in deciding the overall efficiency of the

degradation process. (3) Recently, the possibility of combining the solar photo-Fenton and biological process has also been proposed considering the increase in biodegradability after photo-Fenton process. (20, 21, 22)

In this paper the degradation of the Dazomet has been studied by Fenton reactions using UV-visible spectrophotometer to observe the degradation of the Dazomet.

Materials and Methods:

Chemicals

Table 1 shows all chemicals used in this work, their purity available and supplier companies.

Table 1. Supplier Company and Purity of Used Materials

No	Chemical materials	Molecular formula	Supplier	purity
1	Dazomet	$\text{C}_5\text{H}_{10}\text{N}_2\text{S}_2$	Unifert Company	98%
2	Ferrous sulphate heptahydrate	$\text{FeSO}_4 \cdot 7\text{H}_2\text{O}$	BDH	99.5%
3	Hydrogen peroxide	H_2O_2	Merk Germany	30%

Instrumentation

Table 2 illustrates the list of instruments used in this work, their manufactures, brand, and country of supplier.

Table 2. The Used Instruments, their Manufactures, Brand and Suppliers

No.	Instrument	Brand	Country of supplier
1.	pH meter	Milwaukee	USA
2.	Centrifuge	Gimi	Taiwan
3.	UV-Visible spectrophotometer	Bio-rad	USA
4.	Analytical sensitive balance	Sartorius	Germany
5.	Recirculating chiller	wise	Daihan Scientific
6.	High performance liquid chromatography	Shimadzu	Japan
7.	Hot plate stirrer	Wise	Daihan Scientific
8.	Ultrasonic bath	Quigg	Germany

Irradiation System

In this work irradiation system (Fig. 2) consists of Pyrex photoreaction cell 75 ml capacity with a quartz window fitted with a focusing lens to ensure parallel beam of light. The mercury lamp 125 watt was placed 10 cm apart from the photoreaction cell. The cell is supplied with two openings of 0.5 cm in diameter and one of these was used for sampling processes. The magnetic stirrer was used to keep the catalyst aqueous suspension in homogeneous form during the photolysis experiments, and the circulating thermostat was used to control the reaction temperature.

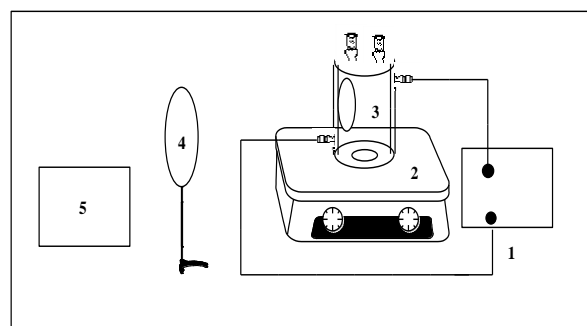

Figure 2. Irradiation System; 1- Circulator, 2- Magnetic stirrer, 3- Photoreaction Cell, 4-Lens, and 5- UV- Source

Preparations of Stock Solution and Standard Calibration Curve of Dazomet

Fig. 3 shows the standard calibration curve of Dazomet. According to the results of calibration curve, it has been found that the best concentration

to use in experiments is 25 ppm where above the concentration the absorbance is higher than 2 as (beer- lambert law) and the absorbance values

recorded through this work transferred to concentration using calibration curve.

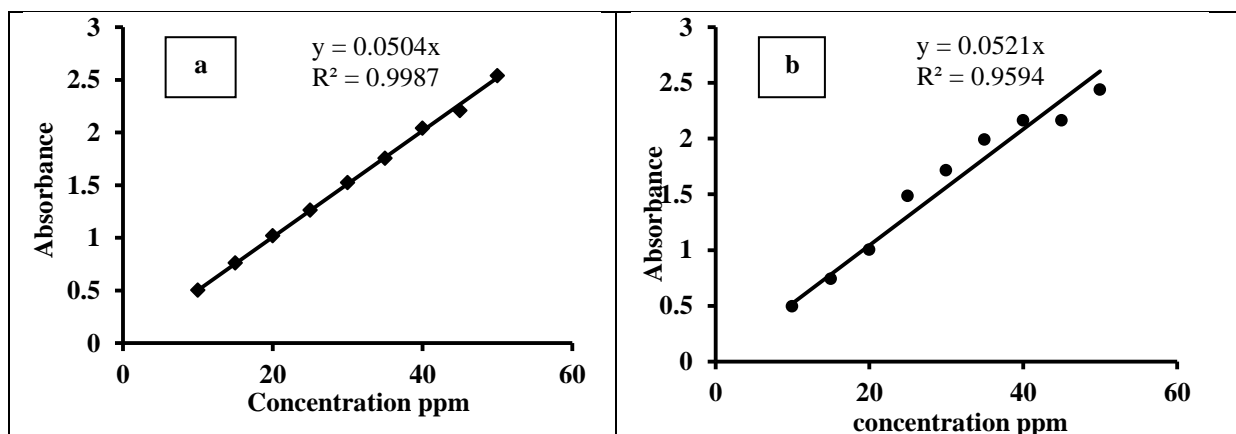

Figure 3. Calibration Curve of Dazomet at (a) 249 nm and (b) 281 nm Respectively.

Procedure of Degradation of Dazomet by Thermal Fenton, Photo-Fenton Reaction and Solar Fenton.

All of the experiments were carried out in the photoreaction cell using (irradiation system) Fig. 2. Firstly several concentrations of H_2O_2 (30%) were added, secondly different concentrations of $FeSO_4 \cdot 7H_2O$ were used, **thirdly** different buffer solutions pH (3, 5, 7, 9) (prepared by using HCl, NaOH, $C_8H_5KO_4$, K_2HPO_4 , $C_4H_{11}NO_3$) were used to find the best media for the reaction, circulating thermostat was used to control the reaction temperature, while magnetic stirrer was used to mix the mixture, the solutions was irradiated with medium mercury lamp (in photo-Fenton processes). Then 5ml aqueous solution of mixture from each experiment is taken at various time intervals (10 min during 90 min), then $FeSO_4 \cdot 7H_2O$ was removed from the samples by using centrifuge. After that, the absorbance of Dazomet was measured by using UV-Visible spectrophotometer at wavelengths 249 nm and 281 nm to determine the optimum values of $FeSO_4 \cdot 7H_2O$, H_2O_2 and pH. A series experiments was repeated using different temperatures (25, 30, 35, 40 and 45°C) to determine the best temperature for degradation of pesticide at optimum values of catalysts. A solar Fenton experiment was carried out by putting 75 ml of Dazomet solution 25ppm on Pyrex beaker and optimum values of $FeSO_4 \cdot 7H_2O$, H_2O_2 were added at pH 7 then covered by thick quartz plate which the sun light could enter through quartz plate. The experiment was performed at 12 pm on mid July 2017.

The percentage degradation of dazomet was calculated by using the following equation. (23)

$$\%D = \frac{C_0 - C_t}{C_0} \times 100 \quad \dots(9)$$

Where, %D: The percentage degradation, C_0 : The initial concentration (mg/L) at zero time.

C_t : The final concentration (mg/L) at any time.

Results and Discussion:

Absorption Spectrum of Dazomet

Fig.4 shows the absorption spectrum of Dazomet pesticide. The change in the absorption of Dazomet was monitored at two wavelengths 249 nm and 281 nm respectively during the experiments as both of the beaks are important to show the change in absorption.

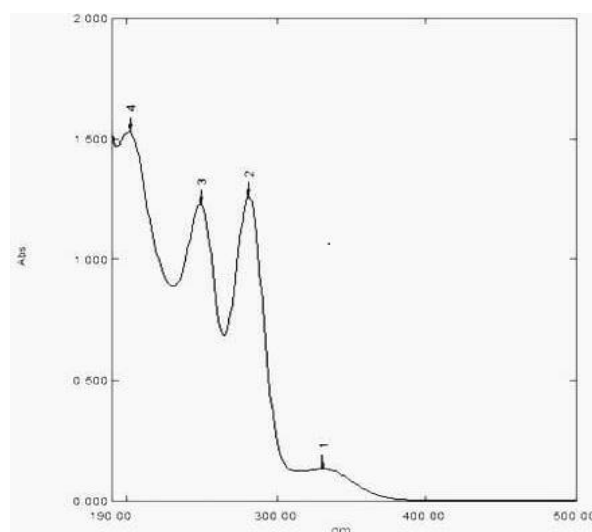

Figure 4. UV-Visible Absorption Spectrum of Dazomet in Aqueous Solution

Photo Fenton Reaction:

Effect of Hydrogen Peroxide H_2O_2 Amount

Fig.5 shows the percentage degradation of Dazomet at different dosage of H_2O_2 varying from 3-5 μ l. to determine the optimum value of H_2O_2 for the best degradation of Dazomet at 25 °C within

irradiation time 90 min, pesticide removal increases with increasing the amount of H_2O_2 till $3.5 \mu l$, where the percentages of degradation was 78% and 89% at 249 and 281 nm respectively. After that, the percentage of removal decreases with increasing the

amount of H_2O_2 . From the results, it can be noticed that the excess H_2O_2 does not improve the removal efficiency, because H_2O_2 converts to oxygen and water. (23)

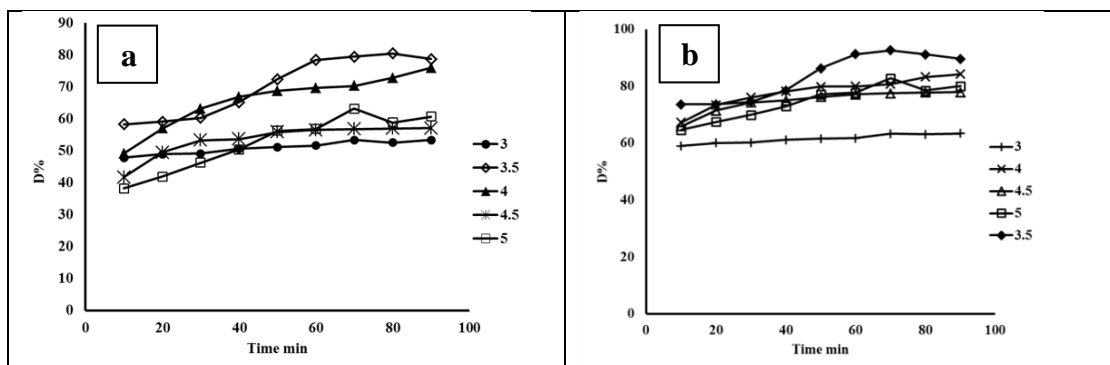

Figure 5. Percentage Degradation of Dazomet on Photo Fenton with Varying Amount of H_2O_2 at (a) 249 nm and (b) 281 nm.

Effect of Ferrous Sulphate Heptahydrate $FeSO_4 \cdot 7H_2O$ Amount

Various amounts of Ferrous sulphate heptahydrate ($FeSO_4 \cdot 7H_2O$) were added to aqueous solution of Dazomet (25 ppm) to determine the optimum value of ferrous sulphate heptahydrate at fixed amount of H_2O_2 ($3.5 \mu l$) and $25^\circ C$ within irradiation time 90 min. Fig. 6 shows the degradation percentage (D%) of Dazomet, it can be observed that the degradation of Dazomet increases

with increasing the amount of $FeSO_4 \cdot 7H_2O$ till attaining an optimum value of $FeSO_4 \cdot 7H_2O$, which is 0.07 g, where the percentages of degradation reach to 87% and 96% at 249 and 281 nm respectively. After that, the degradation will be decreased, owing to the fact that when Fe^{+2} concentrations become higher, most of the HO^\bullet radicals were used in the side reactions effectively. (23)

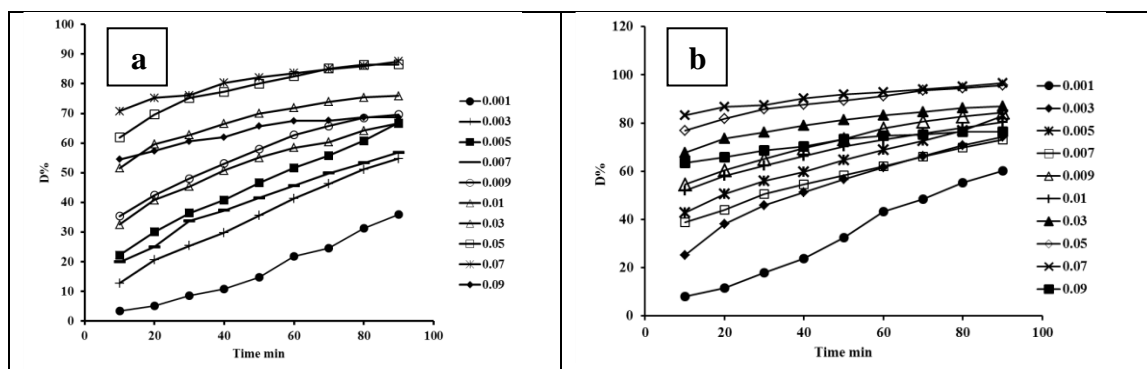

Figure 6. Percentage Degradation of Dazomet with Photo Fenton Process at Various $FeSO_4 \cdot 7H_2O$ Concentrations at a) 249 nm and b) 281 nm.

Effect of pH

Fig.7 shows the effect of pH on the degradation of Dazomet in aqueous solution at different pH ranging from 3-9. It can be easily depicted that the maximum degradation achieved at pH 7 (optimum pH) where the percentages of degradation was 54% and 63% at 249 and 281 nm respectively at fixed amounts of $FeSO_4 \cdot 7H_2O$

(0.07g) and H_2O_2 ($3.5 \mu l$). This may happen because at higher pH, ferrous ions get easily converted to ferric ions, which have a tendency to produce ferric hydroxo complexes with H_2O_2 . While at lower pH, the HO^\bullet radical scavenges by H^+ ions and therefor may inhibit the radical forming activity of iron. (24)

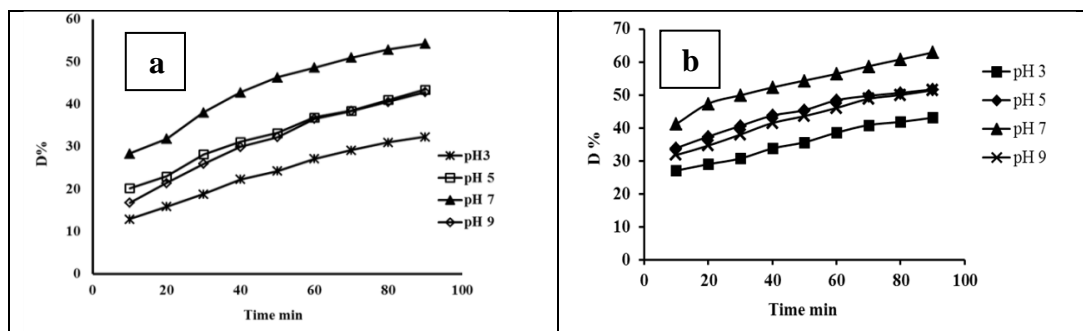

Figure 7. Percentage Degradation of Dazomet on Photo Fenton Reaction with Varying pH Solutions at a) 249 nm and b) 281 nm.

Thermal Fenton Studies

Effect of Amount of Hydrogen Peroxide H₂O₂:

Fig. 8 illustrates the effect of amount of H₂O₂ on Fenton reaction of degradation of aqueous solution of Dazomet (25 ppm), added in range 3-4.5 μl. It is observed that the highest percentage of degradation was at 3.5 μl. It can be explained that

more of H₂O₂ molecules, increases the number of HO[•] radicals. Therefore, the rate of reaction increases but on further increasing of H₂O₂, while the rate of reaction decreases because most of the HO[•] radicals are consumed by the H₂O₂ and there are less HO[•] radicals available which will slow down the reaction but there is less degradation compared with photo-Fenton process. (25)

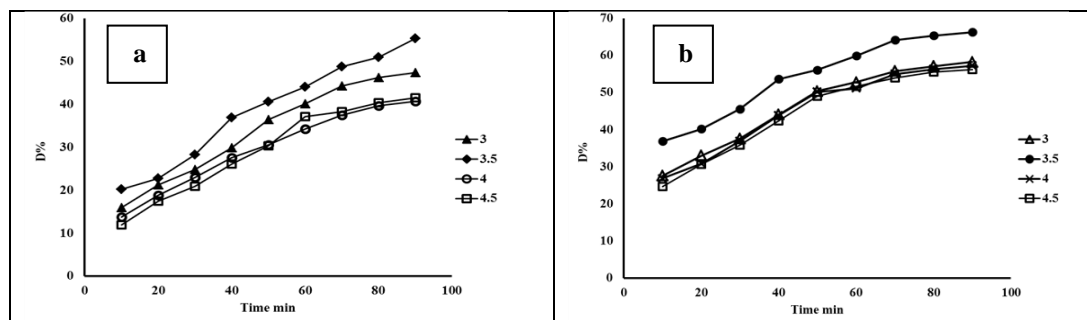

Figure 8. Percentage Degradation of Dazomet on Thermal Fenton Reaction with Varying Amount of H₂O₂ at a) 249 nm and b) 281 nm.

3.3.2 Effect of Ferrous Sulphate Heptahydrate FeSO₄ .7H₂O Amount

Thermal Fenton experiments were performed in dark by covering the aqueous solution of Dazomet container with aluminum foil to make it away from light and magnetic stirrer was used so that proper mixing takes place. Fig.9 shows that the optimum value of FeSO₄ .7H₂O is at irradiation time 90 min and temperature 25 °C with fixed amount of H₂O₂ (3.5 μl) . It has been noticed that the

percentage degradation of dazomet with thermal Fenton reaction at optimum value of FeSO₄ .7H₂O (70%, 66.8% at 249 and 281 nm respectively) was less than percentage removal of dazomet with photo Fenton reaction where the percentages of degradation were 87%, 96% at 249 and 281 nm respectively. The reason is when there is no light during the reaction, Fe⁺³ ions are accumulated in the system and after Fe⁺² are consumed, the reaction partially stops. (26)

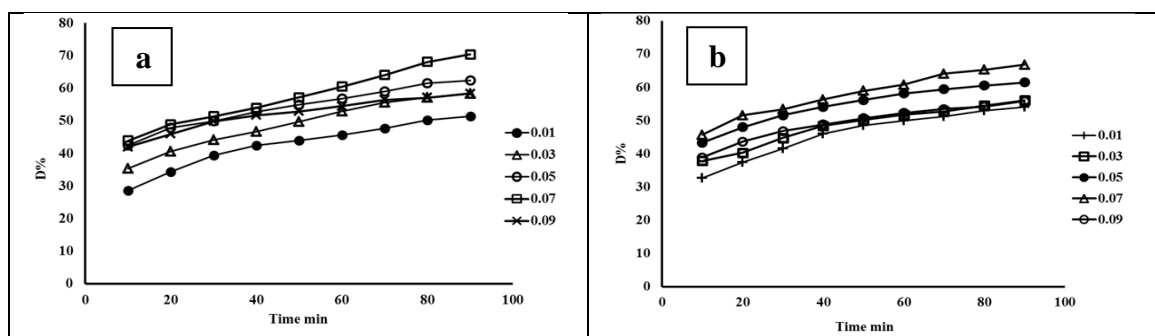

Figure 9. Percentage Degradation of Dazomet on Thermal Fenton Reaction with Varying FeSO₄ .7H₂O at a) 249 nm and b) 281 nm.

Effect of pH

The pH effect on thermal Fenton reaction for Dazomet degradation in aqueous solution was studied as shown in Fig.10. The degradation was investigated in the pH range 3 – 9 at fixed amounts of FeSO₄ .7H₂O (0.07g) and H₂O₂ 3.5 μl), the best value was at pH 7 where the percentages of degradation reach to 44.7% and 51.5% at 249 and

281 nm respectively. When the other parameters were kept constant. In the dark, the reaction has been explained to slow down relative to the photo Fenton reaction after depletion of H₂O₂ because the reconversion of Fe⁺³ to Fe⁺² necessary for the subsequent production of HO[•] radicals is stopped. (26)

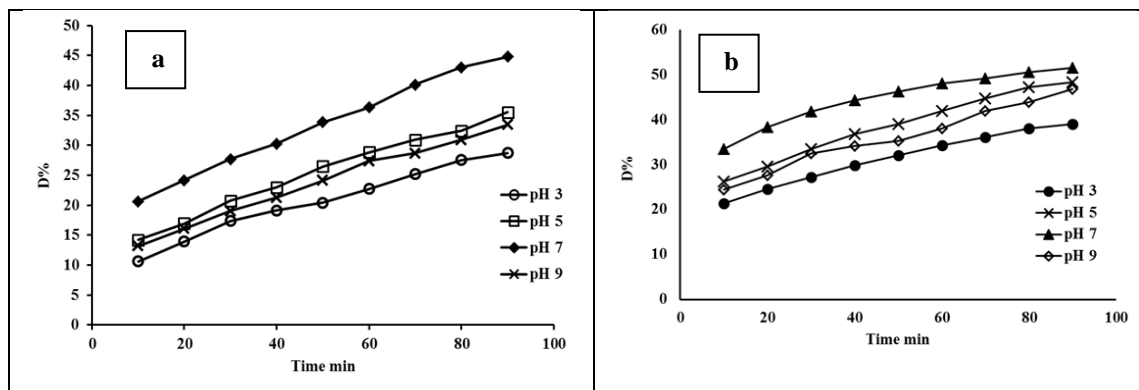

Figure 10. Percentage Degradation of Dazomet on Thermal Fenton Reaction with Varying pH Solutions at a) 249 nm and b) 281 nm.

Sunlight As Light Source in Photo Fenton Process (Solar Photo Fenton Process)

The degradation experiment of 25 ppm Dazomet in aqueous solution was carried out using sunlight as light source through 15 July 2017 at 12 pm at optimum values of FeSO₄ .7H₂O, H₂O₂ and pH

(0.07 g, 3.5μl and pH 7 respectively), at irradiation time 90 min. Fig. 11 shows the results of degradation relation with time. According to the results, the solar photo-Fenton process is more efficient for wastewater treatment than others photocatalytic process in neutral conditions

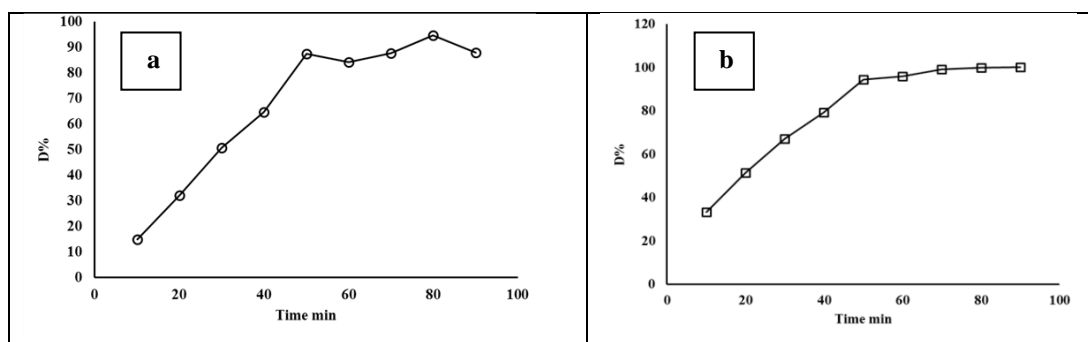

Figure 11. Percentage of Degradation of Aqueous Solution of Dazomet Using Sun Light on Photo Fenton Process at Optimum Values of FeSO₄ .7H₂O, H₂O₂ and pH 7. at a) 249 nm and b) 281 nm.

Dazomet Degradation Results Using Photo Fenton, Thermal Fenton, and Solar Photo Fenton Processes

It has been found that the highest degradation of aqueous solution of Dazomet has

been obtained from solar photo-Fenton reaction as shown in Table 3.

Table 3. Percentage Degradation of Fenton Processes at Optimum Values of Ferrous Sulfate, Hydrogen Peroxide (0.07g FeSO₄ .7H₂O, 3.5μl H₂O₂) and at pH 7.

λ nm	D% Solar photo Fenton	D% Photo Fenton	D% Thermal Fenton
249 nm	88%	87%	70%
281 nm	100%	96%	66.8%

The reasons for these results were explained from the mechanism described early by the equations (1-5). Irradiation of the Fenton reaction not only regenerates Fe^{+2} , the crucial catalytic species in the Fenton reaction, but also produces an additional hydroxyl radical, the species responsible for the degradation of organic material. As a consequence of these two effects, the photo-Fenton process is faster than the conventional thermal Fenton process. Moreover, since Fe^{+2} is regenerated by light with decomposition of water rather than H_2O_2 , the photo-Fenton process consumes less H_2O_2 and requires only catalytic amounts of Fe^{+2} . The photo-Fenton reaction has several operational and environmental advantages. Therefore the positive effect of irradiation under UV-light or solar light on the rate of degradation is regenerated Fe^{+2} , which leads to increase the $\cdot OH$ radicals compared to Fenton process. This means photo-reduction of Fe^{+3} to Fe^{+2} ions produce secondary $HO\cdot$ radicals with H_2O_2 according to the mechanism of the photo Fenton reaction (eq. 6-8). (27, 28)

values of $FeSO_4 \cdot 7H_2O$ and H_2O_2 (0.07g $FeSO_4 \cdot 7H_2O$, 3.5 μl H_2O_2) at pH 7 at different temperatures in the range (25- 45) °C. It has been found that the Dazomet percentage degradation in aqueous solution increases with increasing temperature. These results could arise from increasing the generation of $\cdot OH$, which would enhance the Dazomet degradation. The Arrhenius expression, showing the relationship between the reaction temperature and rate constant k is expressed as follows:

$$k = A \exp\left(\frac{-E}{RT}\right) \dots (10)$$

where: A is the pre-exponential (or frequency) factor, E is the activation energy ($cal \cdot mol^{-1}$), R is the gas constant ($1.987 cal \cdot mol^{-1} K^{-1}$), T is the reaction absolute temperature (K)

In summary, the temperature has a positive influence on the Dazomet degradation in the photo Fenton reaction and thermal Fenton, but the required activation energy for the photoreaction less the the activation energy for the thermal as we believe that the existence of light in photoreaction enhance the reaction more than in thermal reaction as shown in Table 4. (29, 30, 31)

Effect of Temperature on Reactions

Fig.12 shows the results from series experiments performed by using the optimum

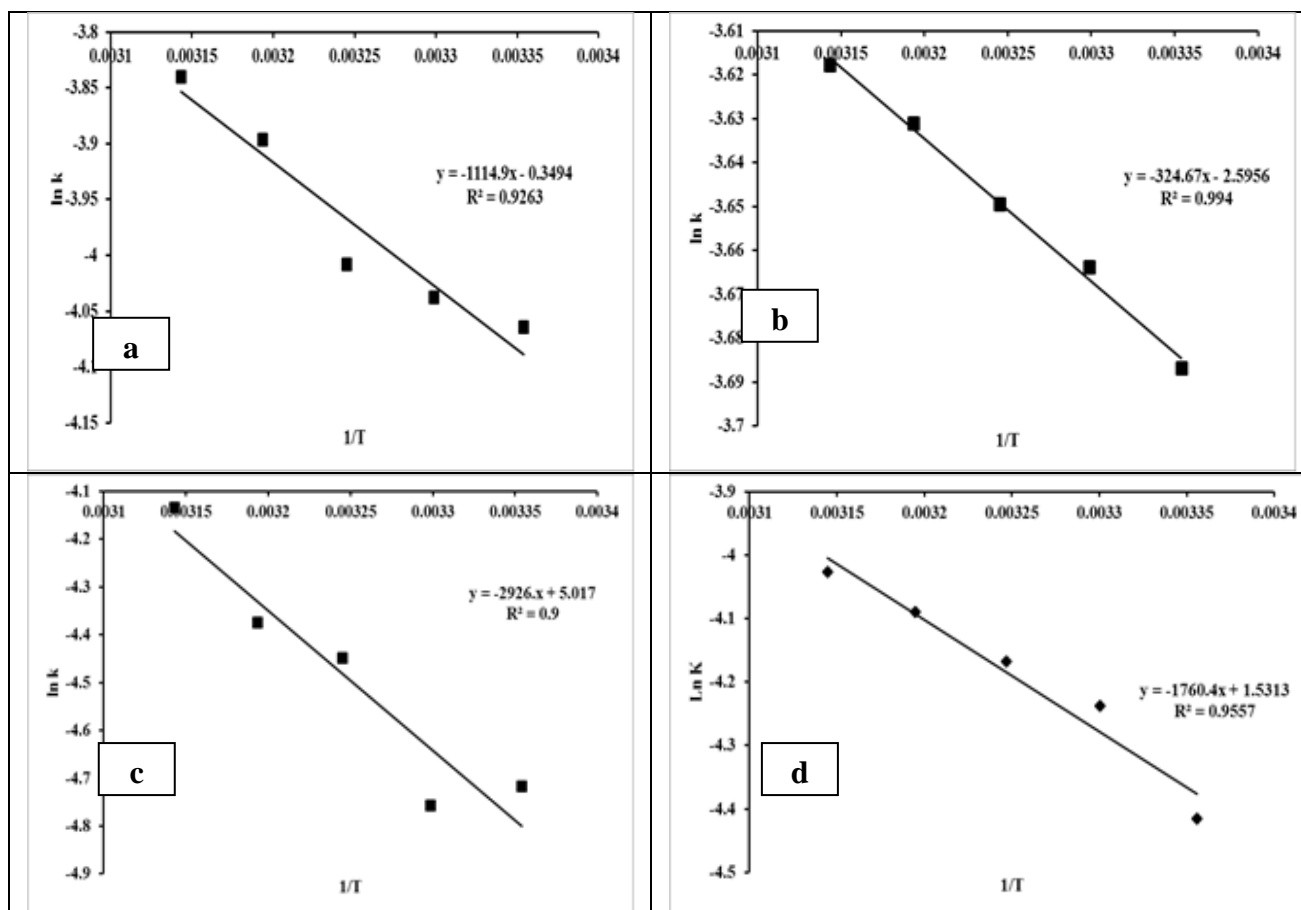

Figure 12. Relationship Between Logarithms Rate Constant Versus 1/T of Dazomet Degradation Using Photo Fenton Reaction at a) 249 nm b) 281 nm, Thermal Fenton c) 249 nm d) 281 nm.

Table 4. Reaction Rate Constants and Activation Energy Values of the Dazomet Degradation at Different Temperatures.

Photo Fenton				
Temperature ⁰ C	k min ⁻¹ at 249 nm	ΔE cal mol ⁻¹	k min ⁻¹ at 281 nm	ΔE cal mol ⁻¹
25	0.017174		0.025051	
30	0.017636		0.025634	
35	0.018163	2228.685	0.026007	649.0153
40	0.020309		0.026489	
45	0.021497		0.026842	
Thermal Fenton				
25	0.00894		0.01209	
30	0.00859		0.01444	
35	0.0117	5849.074	0.01549	3518.24
40	0.0126		0.01675	
45	0.01601		0.01783	

Chromatographic Analysis HPLC of Photo Fenton Process

Figure 14 shows the HPLC chromatogram of Dazomet using photo Fenton processes to degrade

the Dazomet, it can be observed that the absorbency peaks, at retention time in minutes before irradiation, and after irradiation are different.

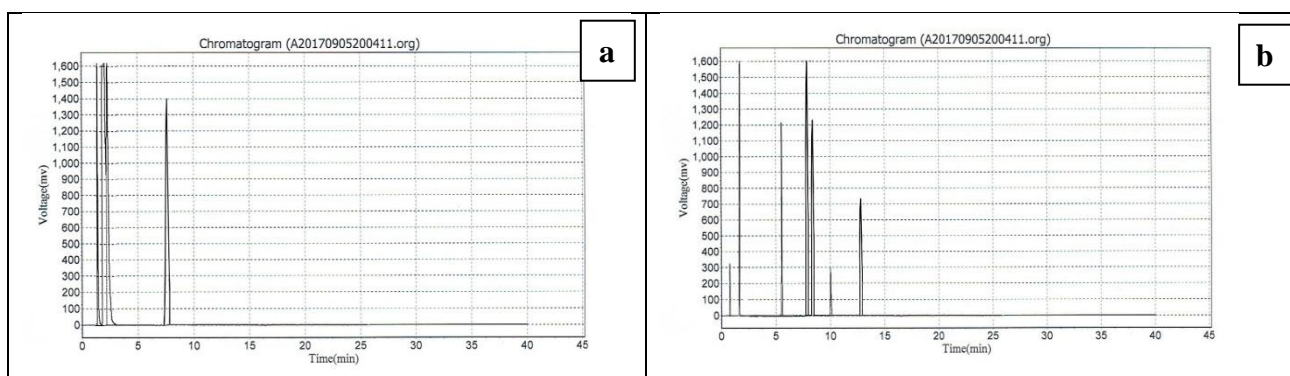
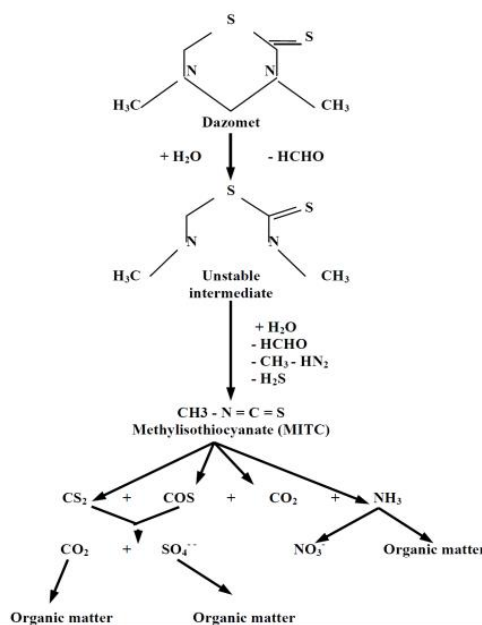

Figure 13. HPLC Chromatogram of Dazomet Using Photo Fenton Process: a) Before Photolysis b) After 120 min.

Mechanism of Pathway Degradation of Dazomet

From a previous study, it can be suggested that the mechanism of photo degradation of Dazomet, after formation the OH[•] radicals, can undergo series of reactions with Dazomet. Scheme 1 can describe the products. (1) Dazomet is rapidly degraded in aqueous media to carbon disulfide, formaldehyde, and methylamine. However, in moist soil it degrades mainly to methyl isothiocyanate. It is unstable and decomposes to methylamine in water, probably via thiocarbamic acid, methyl isocyanide in turn degrades to methyl isocyanate, this product was summarized in the scheme illustrated in the scheme 1. (32)



Scheme 1. Mechanism of Pathway Degradation of Dazomet (32)

Thermodynamics Quantities Calculations

The thermodynamic parameters of activation that must be considered to determine the process are changes in Gibbs free energy (ΔG°), standard enthalpy (ΔH°), and standard entropy (ΔS°).

ΔG° was calculated by

$$\Delta G^\circ = \Delta H - T\Delta S$$

The ΔH° , ΔS° , and ΔG° were calculated by the Eyring equation:

$$\frac{\ln k}{T} = \ln \frac{k_B}{h} + \frac{\Delta S^\circ}{R} - \frac{\Delta H^\circ}{RT} \dots \quad (11)$$

Where; k is the degradation rate constant, k_B is the Boltzman constant ($1.3807 \times 10^{-23} \text{ J K}^{-1}$), h is the

plank constant ($6.6261 \times 10^{-34} \text{ Js}$), R is the gas constant ($1.989 \text{ cal mol}^{-1} \text{ K}^{-1}$), T is temperature (K). Table 4 shows the calculated quantities of Gibb's free energy (ΔG°), enthalpy (ΔH°) and entropy (ΔS°). It can be seen from these results that the enthalpy and Gibb's free energy values in photodegradation are less than the values in thermal degradation, due to the existence of light which plays a role in enhanced the degradation of Dazomet. Additionally the Table shows that the values of entropy in photodegradation are negative which are attributed to stimulated process, where the thermal degradation can be happened spontaneously, so the entropy values are positive.

Table 4. Thermodynamic Quantities of Dazomet Degradation Using Photo-Fenton and Thermal Fenton Processes.

Photo-Fenton process						
	k min	D%	R	$\Delta H^\circ \text{ cal mol}^{-1} \text{ K}^{-1}$	$\Delta S^\circ \text{ cal mol}^{-1} \text{ K}^{-1}$	$\Delta G^\circ \text{ cal mol}^{-1} \text{ K}^{-1}$
249 nm	0.0231	87.528	0.9263	2228.0850	-0.5990	2406.61
281 nm	0.0374	96.06	0.994	649.0153	-5.1478	2183.074
Thermal Fenton process						
	k min	D%	R	$\Delta H^\circ \text{ cal mol}^{-1} \text{ K}^{-1}$	$\Delta S^\circ \text{ cal mol}^{-1} \text{ K}^{-1}$	$\Delta G^\circ \text{ cal mol}^{-1} \text{ K}^{-1}$
249 nm	0.0135	70.34	0.9	5849.074	10.2546	2793.188
281 nm	0.0122	66.8	0.9557	3518.24	3.0328	2614.454

Conclusion:

It can be concluded from this work that the pesticide Dazomet has been degraded using Fenton reactions (photo-Fenton under UV-light and sun light and thermal Fenton). The optimum values of all used catalyst have been figured out, in addition, pH of the reaction media has been found out. the effect of temperature on all the reactions has been studied in the range (25 -45)°C, it has been noticed that rate constant of the degradation (k) has increased with increasing temperature, and the best percentage degradation of Dazomet was at 45°C in all processes. The thermodynamic functions of activation ΔG° , ΔH° , ΔS° have been calculated.

Acknowledgements:

Grateful acknowledgment is due to the University of Baghdad for financially supporting this research.

Conflicts of Interest: None.

References:

- Gurusinghe PG, Roush T, Wofford P, Sava R, Segawa R, Feng H, et. al. Environmental Monitoring results of basamid G(Dazomet) application in Watsonville, California 2006. Lincoln University,2008;1-41
- Morarj RL. Degradation and biological activity of dazomet. Ph.D Thesis, Loughborough University Institutional Repository;1982.
- Morrell JJ, Sexton CM, Lebow S. The effect of pH on decomposition of Myloneb (Dazomet) and tridipam to fungitoxic methylisothiocyanate in wood. SWST. 1988;20(4):422-430.
- Subramanian P, Teesch L, Thorne PS. Degradation of 3,5-Dimethyl-Tetrahydro-2H-1,3,5-Thiadiazine-2-Thione in aqueous aerobic media. Environ. Toxicol. Chem. 1996;15(4): 503-513.
- Juzwik J, Stenlund DL, Allmaras RR, Copeland SM, Mcroberts RE. Incorporation of tracers and dazomet by rotary tillers and a spading machine. SOIL TILL RES. 1997; (41):237-248.
- Petanovska-Ilievska BR,Lila B Vodeb LB. Determination of Dazomet in Basamid Granulat Using Reversed Phase HPLC. Croat. Chem. Acta. 2002;75(1): 225-234.
- Fraedrich SW, Dwenill LD. An evaluation of dazomet Incorporation methods on soil-borne organisms and pine seedling production in southern nurseries. SOUTH J APPL FOR. 2003; 27(1):41-49.
- Blasco C, Font G, Picó Y. Determination of dithiocarbamates and metabolites in plants by liquid chromatography-mass spectrometry. J Chromatogr. A. 2004; (1028):267-276.

9. Erçağ E, Erçağ A, Apak R. Spectrophotometric determination of the soil fumigant:dazomet with copper(II)–neocuproine reagent. *Anal. Chim. Acta.* 2004; (505):95–100.
10. Iusarski CS, Pietr SJ. Combined application of dazomet and *Trichoderma asperellum* as an efficient alternative to methyl bromide in controlling the soil-borne disease complex of bell pepper. *Crop Prot.* 2009;(28):668–674.
11. Ali IH. A Study of adsorption of Dazomet from aqueous solution on Kaolin. *JNUS.* 2009;12 (1):38-43.
12. Dhahir SA, Kadhim NJ, Ayal AK. Sunlight Photocatalytic of dazomet herbicides in aqueous solution. *JKU.* 2011;9 (1):182-187.
13. Barbusinskki K. Fenton reaction controversy concerning the chemistry. *Eco. Chem. Eng.* 2009; 16(3):347-358.
14. Mwebi NO. Fenton and Fenton like reactions: Nature of oxidizing intermediates. Ph.D Thesis. University of Maryland; 2005.
15. Rossi AF. Fenton's process applied to wastewaters treatment heterogeneous and homogeneous catalytic operation modes. Ph.D Thesis. University of Coimbra;2014.
16. Ebrahiem E, Al-Maghrabi M, Mobarki A. Removal of organic pollutants from industrial wastewater by applying photo-Fenton oxidation technology. *Arab. J. Chem.* 2017;(10):S1674-S1679
17. Ertugay, N, Nuran Acar F. Removal of COD and color from Direct Blue 71 azo dye wastewater by Fenton's oxidation: Kinetic study. *Arab. J. Chem.* 2017;(10):S1158-S1163.
18. Galvão SAO, Mota ALN, Silva DN, Moraes JEF, Nascimento CAO, Chiavone-Filho O. Application of the photo-Fenton process to the treatment of wastewaters contaminated with diesel. *Sci. Total Environ.* 2006; (367):42–49.
19. de Freitas Matos TA, Dias ALN, Reis ADP, da Silva MRA, Kondo M.M. Degradation of Abamectin Using the Photo-Fenton Process. *IJChER.* 2012; (Article ID 915724):1- 7.
20. Philippopolous CJ, Nikolaki MD. Photocatalytic processes on the oxidation of organic compounds in water, book new trends in technologies. Blandnaromov (Ed.). 2010;chapter(6): 90-102.
21. Carneiro PA, Nogueira RFP, Zanoni MVB. Homogeneous photodegradation of C.I. Reactive Blue 4 using a photo-Fenton process under artificial and solar irradiation. *DYES PIGMENTS.* 2007; (74): 127-132.
22. Sreeja PH, Sosamony KJ. A Comparative Study of Homogeneous and Heterogeneous Photo-Fenton Process for Textile Wastewater Treatment. *Proc. Technol.* 2016; (24):217 – 223.
23. Kumar BN, Anjaneyulu Y, Himabindu V. Comparative studies of degradation of dye intermediate (H-acid) using TiO₂/UV/H₂O₂ and photo-Fenton process. *Chem. Pharm. Res.* 2011; 3(2): 718-731.
24. Karale RS, Manu B, Shrihari S. Fenton and Photo-Fenton Oxidation Processes for Degradation of 3-Aminopyridine from water. *APCBEE Procedia.* 2014;(9):25-29.
25. Karr G. Degradation studied of herbicide isoproturon by using heterogeneous solar photo Fenton process (using fly ash). Thesis of Master. Thapar university;2013.
26. Faust BC, Hoigne J. Photolysis of Fe⁺³ – hydroxy complexes as sources of OH radicals in clouds, fog and rain. *Atmos. Environ,* 1990;(24) A :79 – 89.
27. Sohrabi MR, Khavaran A, Shariati S, Shariati Sh. Removal of Carmoisine edible dye by Fenton and photo Fenton processes using Taguchi orthogonal array design. *Arab. J Chem.* 2017;(10):3523-3531.
28. Kavitha V, Palanivelu K. The role of ferrous ion in Fenton and photo-Fenton processes for the degradation of phenol. *Chemosphere.* 2004;(55): 1235-1243.
29. Pourn ShR, Abdul Aziz AR, Daud WM. Review on the main advances in photo-Fenton oxidation system for recalcitrant wastewater. *J Ind Eng Chem.* 2015;(21): 53-69.
30. Samet Y, Hmani E, Abdelhédi R. Fenton and solar photo-Fenton processes for the removal of chlorpyrifos insecticide in wastewater. *Water SA.* 2012;38(4): 537-542.
31. JianHui S, JingLan F, ShaoHui Sh, YunQing P, MengKe S, Yan Sh. Degradation of the antibiotic sulfamonomethoxine sodium in aqueous solution by photo-Fenton oxidation. *Environ. Sci. Technol.* 2012;57(5): 558-564.
32. Ullah S. Biocides in papermaking chemistry. Master Thesis. University of Jyväskylä; 2011.

تجزئة الدايزوميت باستخدام تفاعلات الفنتون الحرارية والضوئية تحت الاشعة فوق البنفسجية واشعة الشمس بدرجات حرارية مختلفة

سعاد عبد موسى

ايمان عدنان محمد

قسم الكيمياء، كلية العلوم للنبات، جامعة بغداد، بغداد، العراق.

الخلاصة:

في هذا البحث تم دراسة تجزأ مبيد الدايزوميت (رباعي هايدرو-5,3-ثنائي مثيل -2 هيدروجين-5,3,1 ثايدازيرين -2-ثايون) باستخدام تفاعلات الفنتون الضوئية تحت الاشعة فوق البنفسجية وأشعة الشمس وتفاعلات الفنتون الحرارية (في الظلام) حيث تم اجراء التجارب من اجل الحصول على افضل قيم للعوامل المساعدة المستخدمة في التفاعلات الضوئية والحرارية التي هي كبريتات الحديدوز المائية وبيروكسيد الهيدروجين 30%، الاس الهيدروجيني، ودرجة الحرارة والتي حددت عند الحصول على اعلى نسبة تجزأ لمبيد الدايزوميت حيث تم الحصول على القيم المثالية لكبريتات الحديدوز المائية وبيروكسيد الهيدروجين 30% في تفاعلات الفنتون الضوئية (0.07 غرام و3.5 مايكروليتر على التوالي) وان نسبة التجزأ لمبيد الدايزوميت هي (87% 96% عند 249 و 281 نانومتر على التوالي) ، بينما في تفاعلات الفنتون بالظلام لاحظنا ان القيم المثالية لكبريتات الحديدوز المائية وبيروكسيد الهيدروجين 30% هي (0.07 غرام و3.5 مايكروليتر على التوالي (نفس القيم في عمليات الفنتون الضوئية في حين نسبة التجزأ لمبيد الدايزوميت هي (70% و66.8% عند 249 و 281 على التوالي)، علاوة على ذلك ، في عملية الفنتون الضوئية تحت اشعة الشمس تم الحصول على نتائج تشير الى ان نسبة تجزأ الدايزوميت هي (88% و 100% عند 249 و 281 نانومتر على التوالي) باستخدام القيم المثالية لكبريتات الحديدوز المائية وبيروكسيد الهيدروجين 30% و الاس الهيدروجيني التي حددت مسبقا. من هذه النتائج وجد ان نسبة تجزأ مبيد الدايزوميت باستخدام تفاعل الفنتون الضوئي تحت اشعة الشمس اعلى من تفاعل الفنتون الضوئي تحت الاشعة فوق البنفسجية وتفاعل الفنتون بالظلام. كما وجد ان الوسط المتعادل هو الافضل (pH 7) لجميع التفاعلات. وتم دراسة تأثير درجة الحرارة على جميع التفاعلات ضمن المدى (25- 45 م°) حيث لوحظ ان ثابت سرعة التفاعل يزداد بازدياد درجة الحرارة وان افضل نسبة تجزأ للدايزوميت كانت عند درجة حرارة 45 م° في جميع التفاعلات، كما تم حساب قيم الدوال الترمودايناميكية: الانثالبي، الانتروبي و طاقة كبس الحرارة.

الكلمات المفتاحية: تفاعلات الفنتون، تجزئة الدايزوميت، المحفزات الضوئية، التجزئة الضوئية للمبيدات.