



## Optimum Design of Buttress Dam Using Genetic Algorithm

Noor Nazar Al-Bayati<sup>a</sup> , Chelang A. Arslan<sup>b</sup>

<sup>a,b</sup>Department of Civil Engineering, University of Kirkuk, Kirkuk, Iraq

### PAPER INFO

#### *Paper history*

Received: 30/08/2023

Revised: 29/11/2023

Accepted: 19/12/2023

#### *Keywords:*

Genetic Algorithm

Optimization

Buttress dam

FSO

FSS

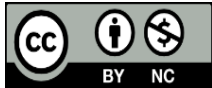

Copyright: ©2023 by the authors. Submitted for possible open access publication under the terms and conditions of the Creative Commons Attribution (CC BY-NC 4.0) license.

<https://creativecommons.org/licenses/by-nc/4.0/>

### ABSTRACT

Designing large structures like dams requires carefully selecting various geometric, hydraulic, and structural characteristics. The required structural design and performance criteria are considered when selecting these characteristics. In order to find the best solution, a variety of restrictions must simultaneously be carefully taken into account. This study presents an effective method for determining the optimal shape design for concrete buttress dams. The research was divided into two crucial phases. The dam's initial design and subsequent modeling were mostly done using DIANA FEA and traditional design and stability analysis. After that, a genetic algorithm was used on the MATLAB platform to control optimizing the dam's shape. Three design factors were used in this phase to alter the goal function and to reduce the amount of Concrete used, which decreased project costs. These variables covered three areas of the buttress's cross-section. Two important limitations were scrutinized during this optimization process: establishing a safety margin against overtopping and preventing sliding. The analysis included a detailed assessment of Shear friction stability to complete a thorough stability study. The optimization efforts had a spectacular result, resulting in a significant 52.365% reduction in the total volume of Concrete used, dropping from 19147.5 cubic meters to 9122.55 cubic meters. This decrease was made possible by reducing three distinct components (X1, X2, X3), with respective proportions of 37.5%, 13.33%, and 30%, including two segments related to the buttress and the final segment linked (slab) to the strip footing.

## 1. Introduction

### 1.1 General:

A buttress dam is an engineering marvel that showcases human creativity in using water's power for a variety of advantageous applications. A form of concrete construction known for its distinctive shape; the buttress dam relies on a clever configuration of substantial buttresses to

withstand the weight of the water it is holding back. The stability and durability of the dam are ensured by these buttresses, which are deftly positioned along the dam's downstream face. They effectively distribute the water pressure and balance the forces generated by the reservoir. Buttress dams were developed as a creative response to specific geological and topographical issues that came up during the construction of dams. Unlike

\* Corresponding author: Noor Nazar ALBayati; [nn3822782@gmail.com](mailto:nn3822782@gmail.com) ; +964770076771

conventional gravity dams that rely solely on their massive weight to withstand the pressure of the water, buttress dams utilize a combination of Concrete and the precise positioning of buttresses to resist the hydrostatic forces acting on them effectively.

Throughout history, buttress dams have been successfully implemented in numerous water management projects worldwide, contributing significantly to irrigation, hydroelectric power generation, flood control, and water supply. Their ability to span vast distances and maintain a relatively slim profile makes them suitable for accommodating substantial volumes of water while minimizing the environmental impact. As technology and engineering practices advance, buttress dams persist as an exemplar of mankind's ability to conquer nature's challenges, providing sustainable solutions to water-related demands while harmonizing with the surrounding landscape. This brief explores the fundamental aspects of buttress dams, shedding light on their historical significance and continued relevance in shaping our modern world.

For large-scale projects like buttress dams, which primarily rely on the weight of the components, the cost of the materials is critical to the design and building process. Optimizing the design by reducing the amount of Concrete and associated costs is advised to lower construction costs. Several strategies can be used to do this but to select the most efficient optimization method, it is crucial to comprehend the project's parameters[1] completely. Large structures like buttress dams may be challenging to build using conventional methods because of their numerous drawbacks and multiple objectives. Researchers have consequently developed superior processes and more sophisticated, user-friendly approaches. These methods integrate genetic algorithms and cutting-edge technology, particularly artificial intelligence. This study's use of genetic algorithms has proven effective at solving various optimization problems. The advantages are their direct approach, strong reactivity to shifting conditions, and adaptability. The genetic algorithm is a modern artificial intelligence technique that has received prominence for its effectiveness in solving complicated issues that are big in scope and have a wide range of potential answers.

Optimization problems and design started in the 1960s and many researchers continued it after that. Bersini et al.[1] introduced the genetic algorithm and proposed using a multi-parent crossover operator, which integrates the GA with the simplex method. This unique combination facilitates the creation of novel offspring by incorporating genetic material from two maternal individuals and an additional individual. The researchers concluded that the three crossover operators demonstrated superior efficiency compared to the remaining two.

Silvoso et al.[2] study focused on utilizing evolutionary algorithms to optimize the expenses associated with building dams. The study shows that the GA genetic algorithm may accomplish large-scale concrete structure design. They discovered that a dynamic punishment mechanism that permitted some cracking in earlier generations effectively guided the evolutionary algorithm toward the ideal outcome.

Through the use of cubic splines and the incorporation of various shape components, Sun et al.[3] investigated an optimization model for the construction of an arch dam shape. The recommended cubic spline method successfully decreased the ideal volume of the arch dam. Degrees of freedom are crucial to optimizing the design of an arch dam, according to Fanelli[4] When modeling arch dams geometrically utilizing Hermit cubic splines, Akbari et al.[5] proposed a brand-new alternate strategy and an enhanced computational technique. Using genetic algorithms in MATLAB for design optimization and the modeling tool SolidWorks, Sulaibi et al.[6] released a scholarly study that explored the best planning and analysis of an arch dam. The quantity of Concrete needed to build the dam was significantly reduced due to the analysis by 53.75%. Araujo et al.[7] provided a method for designing a gravity dam using the MATLAB platform's Genetic Algorithm (GA). The study concentrated on a gravity dam made of Concrete at Belo Monte, Brazil. By adjusting the dam's height, freeboard height, crest width, and base length, four design factors were adjusted with the primary goal of reducing the cross-sectional area of the dam. The final objective was to lower dam construction's overall cost. However, the study was limited by including safety considerations for sliding, tipping, and floating. In their study, Wang et al.[8] combined SKSM (Shape Kernel Spline Method) and GA

(Genetic Algorithm) to identify the ideal form of single-arch dams. They compared their results to those attained by independent technique studies employing the Genetic Algorithm-Finite Element Method (GA-FEM) and the Genetic Algorithm-Kernel Spline Method (GA-KSM). The thickness of the dam at the base, crest, and  $H/3$  and  $2H/3$  from the top, had an impact on the overall volume of Concrete, an objective function for optimal design. Surprisingly, the GA-SKSM method only required 5.40 computational effort to reach this goal. The findings show how the GA-SKSM method has the ability to greatly improve computational effectiveness and function as a useful tool for optimizing the design of single-curvature arch dams. In their study, Gholizadeh et al.[9] investigated the ideal arrangement of curved dams. The researchers used neural systems and metaheuristics to deal with frequency limitations. The study produced a crucial proposal for an effective soft computing approach that makes use of two important metaheuristics—Genetic Algorithm (GA) and Particle Swarm Optimization (PSO)—to guarantee the best shape design for curved dams. The current study explores the utilization of a genetic algorithm for optimizing the configuration of a buttress dam. The optimization process involves the manipulation of various shape parameters.



Figure 1. Khassa Chai dam

## 1.2 hydrological characteristics the study area

Sogreah (1983) selected rainfall gauging stations with measurements covering long periods in the Khassa Chai catchment's area, or nearby and then calculated, using a planimetric survey, the Thiessen coefficients corresponding to each station and Khassa Chai catchment's area, while this calculation

provides a rainfall index, it is not sufficient to give the average quantity of water falling in Khassa Chai catchment's area each year. The coefficients need to be corrected using the region's mean rainfall isohyets.

The first stage therefore involves calculating the Thiessen coefficients. Only three rainfall gauges may be adopted: Kirkuk, Tuz Khurmatu, Sulaimaiya.[10] Figure (1) shows the Thiessen distribution. It can be seen from this Figure that the Khassa Chai catchment is covered only by the Kirkuk gauging station. The average annual rainfall in the Khassa Chai catchment area from (1935 to 1980) using the Thiessen method is 376 mm.

The second stage involves tracing the mean annual rainfall isohyets for the upper Adhaim region. Figure (2) shows the mean annual rainfall isohyets for the region. The rainfall index can, therefore, be calculated for the Khassa Chai catchment's area as shown in Table (1). The average annual rainfall at the Khassa Chai catchment area (1935 to 1980) using the Isohyets method is 568 mm. The corrected Thiessen coefficient can be calculated  $[568/376=1.5]$

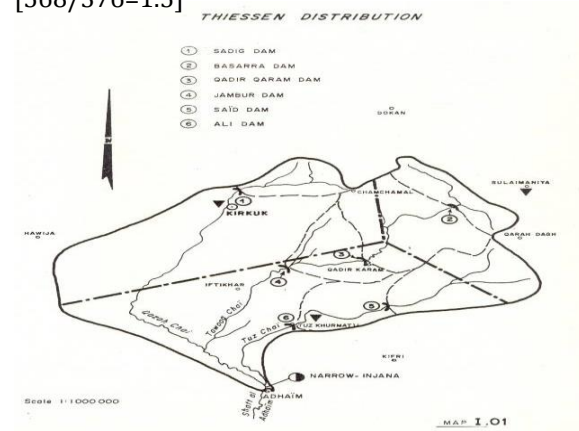

Figure 2. Thiessen Distribution for Upper Adhaim Catchment by Sogreha (1983).



Figure 3. Rainfall Isohyets mope for Upper Adhaim

**Table 1.** Calculation of Isohyets Khassa Chai catchment's area in mm

Isohyets	Area (km <sup>2</sup> )	Average Rainfall	Rainfall Volume
300-400	0	350	0
400-500	98	450	44100
500-600	206	550	113300
600-800	99	700	63900
800-1000	7	900	6300
1000-1200	0	1100	0
total	410	---	233000

## 2. Materials and Methods

### 2.1 Elementary profile of buttress dam

All The Khassa Chi site location was utilized for designing and testing the buttress dam, incorporating all the relevant site information. This included crucial data such as the maximum water depth, the depth of the silt behind the dam, and other pertinent parameters. The simply supported slab type of buttress dam was chosen as an alternative to the one already constructed at Khassa Chi, in the northern part of Kirkuk city. This type of dam features a R.C.C. deck slab that is freely supported by the buttresses, which have corbels to rest on. The deck slab is inclined at approximately 40-55 degrees to the horizontal to effectively support the dead load of a portion of the reservoir water. This inclination provides a stabilizing force in addition to the self-weight of the dam, ensuring it remains secure and prevents any sliding. The initial phase of this research involved the selection of the elementary profile of the buttress dam, which was later modified to accommodate practical considerations. Firstly, the bottom width of the buttress dam was chosen based on two criteria: the stress criterion and the sliding criterion, as depicted in the equations below.

#### 1-Stress criterion

$$B = \frac{H1}{\sqrt{G-1}} \text{ (considering uplift )or} \quad (1)$$

$$= \frac{H1}{\sqrt{G}} \text{ (with no uplift pressure)}$$

#### 2-Sliding criterion

$$B = H1 / (\mu(G-1)) \text{ (considering uplift pressure )or } = H1 / (\mu * G) \text{ (with no uplift pressure)} \quad (2)$$

B represent base of dam, H1 is water height in reservoir, G Specific gravity of soil particles, and  $\mu$  represent to coefficient of friction consecutively.

The width provided for elementary profile should be greater than the width given by the two above equations (1)&(2).

H1:is the water height at U/S. [11] Another important consideration was the inclination angle of the selected buttress slab, which was set to equal a specific value (50°).

### 2.2 Design considerations

Design considerations for buttress dams or buttresses are similar to those for gravity dam sections, with the key difference being the incorporation of buttress thickness 't' to bear the additional load coming from the dam length, which is the sum of the clear spacing between consecutive buttresses (x) and the buttress thickness (t). Therefore, for a meter length of the buttress section, it will bear the loads from (x + t) meters of dam length, as opposed to the unit meter length in a gravity dam section. To account for this, the unit weight of water can be effectively modified by using a surcharge factor (S), which is defined as  $S = (x + t)/t$ . Consequently, the effective unit weight of water is considered as  $\gamma_w * (x + t)/t$ . The design process for buttress sections can be carried out in the same manner as for gravity dam sections, considering unit length and a continuous section. The deck slabs can be designed as simply supported R.C.C. decks, each spanning over two adjacent buttresses, with each deck having a span of x + t meters.[12]

#### 2.2.1 Buttress spacing and Deck slope

##### 2.2.1.i Spacing of buttresses

The most cost-effective spacing of buttresses occurs when the minimum thickness of Concrete is optimally utilized. The determination of this spacing is significantly influenced by the values of the upstream slope of the dam ( $q_1$ ). To achieve economic efficiency, it becomes essential to adjust the buttress spacing according to the height of the

dam. The suggested spacing's for various dam heights are presented in the Table below.[13]

**Table 2.** Recommended buttress spacing[13]

Mean Dam height in m	The recommended buttress spacing in m
<15	4.5
15-30	4.5-7.5
30-45	7.5-12

### 2.2.1.ii Important design ratios

The height, thickness, and spacing of buttresses can be regulated by considering two important factors:

$$\text{Slenderness ratio} = \frac{(\text{Height of buttress})}{(\text{Thickness of buttresses})} = 12 \text{ to } 15 \quad (3)$$

This ratio helps control the relative slimness or stoutness of the buttresses in proportion to their height.

$$\text{Massiveness factor} = \frac{(\text{Spacing of buttress})}{(\text{Thickness of buttresses})} = 2.5 \text{ to } 3 \quad [12] \quad (4)$$

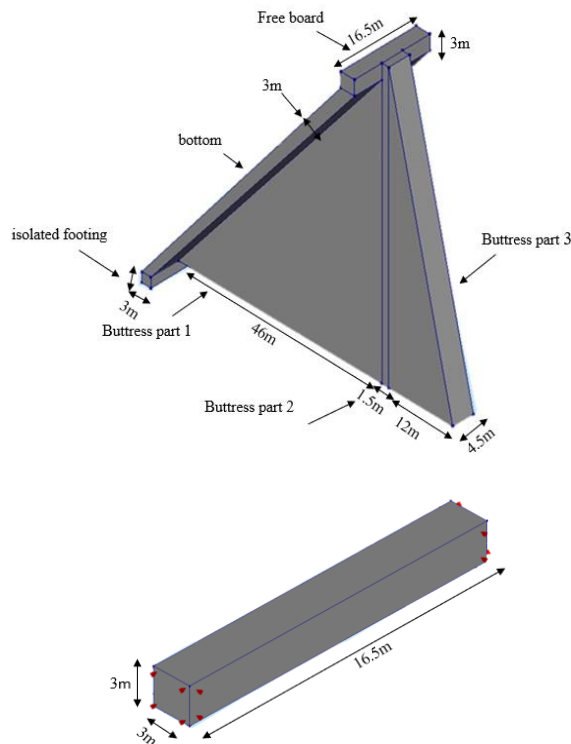

**Figure 4.** (a) Model of concrete buttress dam, (b) Model of foundation

This factor assists in determining the degree of mass or spacing between the buttresses about their thickness. With the considerations mentioned above taken into account for the design of the buttress dam, the dimensions were chosen as depicted in Figure (1).

## 2.3 load applied on buttress dams

Dams are massive constructions vulnerable to a variety of loading scenarios during their life as:

### 2.3.1 Dead Weight:

The weight of the buttresses and the faces upstream and downstream are examples of dead loads. The buttresses can independently carry the dead load because the combination of the normal pressure on the sloped contact and an appropriate friction angle is adequate to prevent any sliding of the slab about the buttress. This occurs regardless of the specific details of the connection.[14]

### 2.3.2 Hydrostatic Pressures Exterior:

The impact of hydrodynamic pressures on slab and buttress dams warrants greater attention than that given to gravity dams. The water flow over an ogee crest generates hydrodynamic forces that exceed the flow depth or result in a negative pressure, causing the slab to lift off the buttresses. The dam's upper region may experience sub-atmospheric negative pressures, while bucket pressures may approach the jet stagnation pressure. The impact of hydrodynamic forces on the structural integrity of a slab and buttress dam's thin slabs is a matter of concern, as they may not have been sufficiently reinforced to endure the elevated pressures induced by flood loading. However, the mass concrete of a gravity dam remains unaffected by such forces.

In addition, ensuring efficient ventilation of the interior of these hollow dams is imperative. During a flood event characterized by a swiftly rising tail water, the formation of an air pocket within the dam can exert upward pressure on the structure, as depicted in Figure (1). The vertical load negatively impacts the structure's overall stability, and it may result in the displacement of slabs from the buttresses. [13]

### 2.3.3 Hydrostatic Internal Loading:

the reduction of uplift at the interface between Concrete and rock can be achieved significantly by establishing buttresses directly on rock or spread

footings. This is because the gaps between the buttresses provide adequate drainage. In such scenarios, it is a justifiable assumption that the uplift fluctuates between the headwater pressure at the upstream face and the tail water pressure at the downstream boundary of the upstream face slab or arch. It can be inferred with certainty that the uplift pressure below the remaining buttress or buttress footing is attributable to the tail water pressure.[13]

### 2.3.5 The uplift forces:

should be analyzed similarly to concrete gravity dam uplift pressures when investigating failure planes within the foundation. The nature of the foundation below the dam greatly controls the reaction shown by the dam. In the case of a mat dam, uplift pressure is tacking account, while the effect of the uplift pressure is reduced in the presence of the isolated footing and is ignored, as in this study.

### 2.3.6 Earthquake Forces:

Concrete buttress dams exhibit similar behavior to that of other types of dams when subjected to earthquake forces. The application of horizontal acceleration is recommended in both the transverse(i.e.,upstream-downstream)and longitudinal (i.e.,cross-valley) directions[15]. It is recommended that separate analyses be conducted for each application. Vertical acceleration should also be taken into consideration. The hydrodynamic pressures induced by an earthquake in dams supported by the seismic coefficient method are influenced by the upstream slope of the dam. As per Zangar (1952) findings, the rise in pressure caused by a horizontal earthquake can b predicted for dams with constant upstream slopes from:

$$P_e = \frac{1}{2} \alpha w h C_m [y/h (2 - \frac{y}{h}) + \sqrt{y/h(2 - y/h)}] \quad (5)$$

$P_e$ : pressure increase,  $\alpha$ : intensity of horizontal eartcuak,  $C_m$ : max.value of cofficent C.y: depth of pressure inceace, h: dam height.

At the base of a dam, where the vertical coordinate is denoted by  $y = h$ , the expression for the hydrostatic pressure  $P_b$  (equivalent to the pressure at the base) can be derived:

$$P_e = K w h C_m \quad (6)$$

This Figure depicts the maximum value of the coefficient C and the values for the coefficient at the base of dams for various upstream face inclinations from vertical and the total horizontal force above the base, in pounds per foot, is :

$$V_b = 0.726 P_b h \quad (7)$$

$M_b$  is the cumulative torque required for overturning is calculated as follow:

$$M_b = 0.299 P_b h^2 \quad (8)$$

All the loads above will be calculated and assessed. Subsequently, a stability analysis will be conducted based on various load combinations. Various modes of failure will be considered, and corresponding safety factors will be calculated and verified.

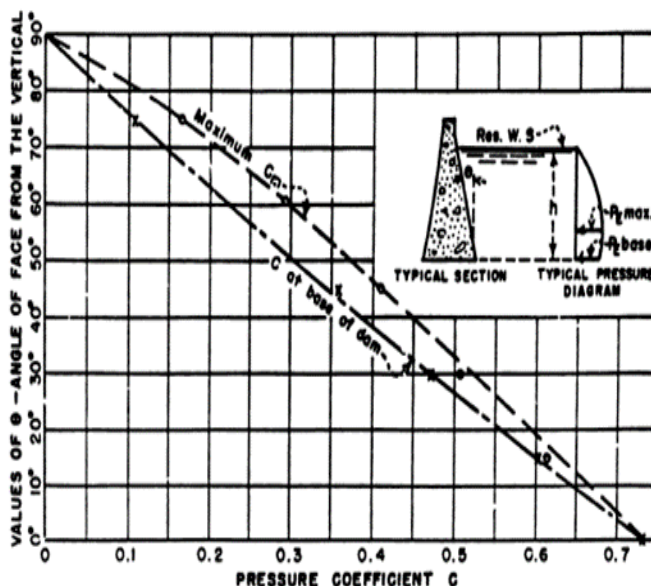

Figure 5. Increased Pressure Coefficients for Continuously Sloping Faces[14]

## 2.4 Stability Considerations.

### 2.4.1 Overturning stability

The safety factor pertaining to overturning must adhere to the prescribed guidelines, ensuring it remains above the recommended thresholds. This safety factor is computed using Equation. It represents the relationship between stabilizing moments and overturning moments, safeguarding the structural integrity. The selection of the rotation axis requires careful consideration, factoring in both the structural strength and the foundation's characteristics. In instances where a robust foundation is present, the axis of rotation is conventionally positioned at the monolith's toe.

$$FSO = \frac{\sum MR}{\sum MO} \quad (9)$$

$\sum MR$ : sum of moment right,  $\sum MO$ : sum of overturning moment Should be  $FSS > 2$  or  $2.5$ . [11]

### 2.4.2 Sliding stability

If the magnitude of the horizontal forces causing sliding surpasses the resistance offered at the dam's base or any other point, the dam will experience failure due to sliding. The resistance to sliding can be attributed to either friction in isolation or a combination of friction and shear strength of the joint. Determining a structure's resistance to sliding involves utilizing a safety factor as a basis for assessing its sliding stability. Should be  $FSS > 1.5$ ,  $\mu$ : Factor For reduce frictional resistance,  $\sum V$ : sum of vertical force,  $\sum H$ : sum of horizontal force [11]

### 2.4.3 Shear friction stability

This criterion incorporates shear forces into the calculations. The permissible shear stress value ranges from 7 to 14 kg/cm (0.25 shear resistance). The static friction coefficient falls within the range of 0.65 to 0.75. According to USBR standards, this value, when seismic forces are not considered, must exceed 4. It should be greater than 1.5 when considering seismic forces to mitigate potential financial and human losses.

$$FFS = \frac{\mu \sum V_r + b * \sigma}{\sum H} \quad (11)$$

$\sigma$ : Allowed shear tension at shear surface [12]

## 2.5 Genetic Algorithms

Genetic Algorithms are a category of probabilistic algorithms that fall under the broader classification of Evolutionary Algorithms. This group constitutes a family of computational models inspired by the intricate process of natural evolution [17]

The concept of GAs was originally conceived in 1960 by the American scientist John Holland [17]. Its primary objective at inception was to delve into phenomena associated with species adaptation and natural selection, while simultaneously formulating a methodology for integrating these fundamental concepts into computing. In 1975, Holland authored the book "Adaptation in Natural and Artificial Systems," which marked the inception of Genetic Algorithms as a formal field of study. This work not only established the theoretical underpinnings of GAs but also explored practical applications. Concurrently, in the same year,

Kenneth De Jong, a student of Holland, concluded his doctoral dissertation titled "An Analysis of the Behavior of a Class of Genetic Adaptive Systems." De Jong's dissertation is the pioneering systematic and comprehensive investigation into using GAs for optimization. The subsequent 1980s decade witnessed another pivotal figure emerging from Holland's tutelage. David E. Goldberg [18], Holland's student, achieved his initial triumph in industrial applications utilizing Genetic Algorithms. Since these ground-breaking milestones, the utilization of GAs has exponentially expanded across various domains and applications.

### 2.5.1 Optimization with Genetic algorithm

The general process of optimization using Genetic

$$FSS = \frac{\mu \sum V}{\sum H} \quad (10)$$

Algorithms (GAs) entails the following steps [18]:

**Generation of Initial Population:** An initial population is created arbitrarily to establish the starting point. The size of this initial population is predetermined. In the context of this study, the initial population comprises twenty solutions, each representing a specific dam volume with distinct dimensions. The objective function is tied to this volume.

**Computation: of Optimal Individuals:** The assessment of individual fitness necessitates the determination of the objective function's value. This study's fitness (objective) function corresponds to the dam body volume, as indicated in equation (12) below. The optimal solution is the one that yields the minimum value for the objective function.

**Selection:** The process involves identifying the most optimal individuals to serve as parents for the subsequent generation. In this study, Tournament selection is employed.

**Application of Genetic Operators, including Crossover and Mutation:** Genetic operators like crossover and mutation are applied to facilitate the creation of new generations or individuals.

**Crossover** involves merging two parent individuals to generate a new child individual. A single point is used as the crossover point in this study. It selects a random integer 'n' within the range of 1 to the number of variables, then gathers vector entries numbered less than or equal to 'n' from the first parent, and genes numbered greater than 'n' from the second parent. These entries are concatenated to form the child individual. For example:

Parent 1 (P1) = [1 2 3 4 5 6 7 8]  
 Parent 2 (P2) = [A, B, C, D, E, F, G, H]  
 Random Crossover Point = 3, Child = [A, B, C, 4 5 6  
 7 8]

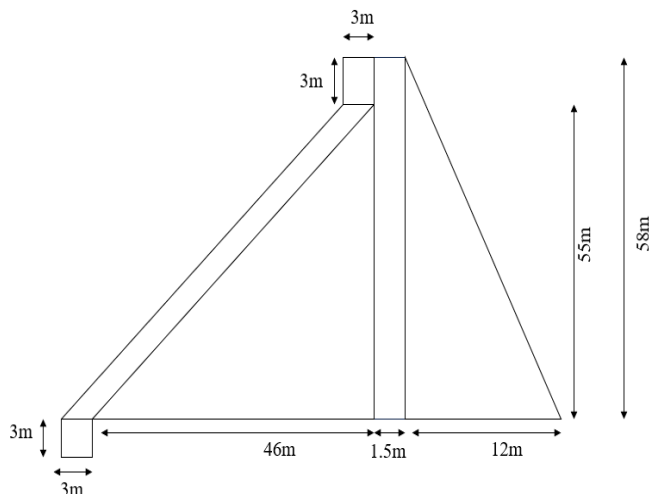

Figure 6. cross section of dam

Mutation functions introduce minor arbitrary changes to individuals within the population. This enhances genetic diversity and enables the genetic algorithm to explore a broader solution space. In this study, the mutation rate is set at 0.01.

**Establishment of Termination Criteria:** Determining when to terminate the optimization process is crucial. For this study, the termination condition defaults to 100 generations, and the stall generations default to 50.

### 2.5.2 Optimum design of Buttress dam

The objective of this study revolves around identifying the smallest volume of Concrete required to maintain the stability requirements[12]. This objective aligns with the overarching goal of minimizing the cost associated with constructing the dam. The optimization conundrum can be succinctly expressed subsequently: Minimize  $V(x)$   
 Subject to:

$$g_j(x) \leq 0, j = 1,2,3, n \quad (12)$$

Where  $x$ : vector of design variables,  $g_j$ : Constraints  
 $V(x)$ : volume of the dam (The objective function which must be minimized).

### 2.5.3. Objective function and design variables:

Several variables directly influence the design of the buttress dam's shape. These variables intricately delineate both the form and dimensions of the dam. As such, the objective of this study resides in the pursuit of optimal values for these variables. This pursuit aims to yield an optimal shape that adheres to design constraints and remains resilient against failure. In this study, the selection of these variables adheres to the subsequent criteria:

The objective function that was set to be minimized in this study is the volume of one strip of designed buttress dam:

$$V(x) = 5692.5 + 1056 \cdot X_1 + 261 \cdot X_2 + 130.5 \cdot X_3 \quad (13)$$

Where  $V$  is dam's concrete body volume,  $X_3$  is width of the strip foundation and slab thickness,  $X_2$  is part 2 of buttress,  $X_1$  is width of part 3 of the buttress as shown in Figure (3).

### 2.5.4 Constraints functions and design constraints

Constraints represent functional interactions between design variables and other design elements, fulfilling particular physical phenomena and resource limitations. The user's judgment will determine the type and number of limitations that should be included in the formulation. Constraints can appear as exact mathematical formulas or take on a more subtle shape[19].

Two different sorts of constraint sets are relevant to form concrete buttress dam. In order to exert control over the design process and make the construction project easier, certain limits are crucial.

Stability constraints in this study were:

1- For safety of Sliding (FSS):

$$FSS = 1.5 - \frac{0.75 \sum_{R(X)} F \uparrow (X_1, X_2, X_3)}{\sum_{H(X)} F \leftrightarrow (X_1, X_2, X_3)} \quad (14)$$

2- For the safety of Overturning (FSO):

$$FSO = 2.5 - \frac{\sum M_R(X_1, X_2, X_3)}{\sum M_O(X_1, X_2, X_3)} \quad (15)$$



The process of optimization can be summarized with following flowchart.

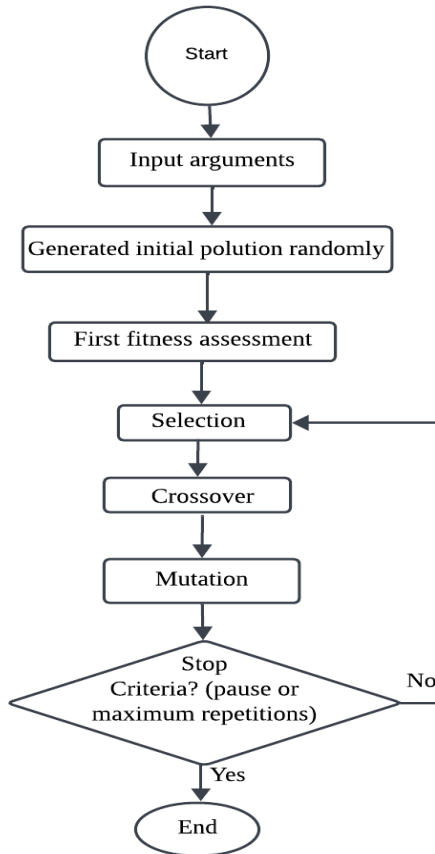

Figure 7. Flowchart of genetic algorithm optimization

### 3. Results and Discussion

#### 3.1 Results of Modelling the buttress dam and Stability check.

In this research, a buttress dam of R.C.C. deck slab type was designed as an alternative to the earthen dam originally constructed, specifically Khassa Chi Dam in Kirkuk. The site selection aimed to leverage vital information from the dam, such as the

maximum water level and sediment deposition height, among other pertinent details essential for dam designs. Figures [1,2] illustrate all the fundamental dimensions of the dam, adhering to the standards mentioned in the preceding section 2.2, wherein the chosen proportions and dimensions were based. Following the initial dimension selection, the stress and sliding criteria were verified according to the provided equations (1) and (2). The dam's foundations were designed based on the sliding and stress criteria during the initial design phase. The maximum base size was selected with consideration of safety measures. Analysis of hydrological data indicated that the maximum water level during typical operating conditions is 55 meters, the height of the water is responsible for the inclination of a front slab [12] in this study, the incline angle is 50 degrees. Subsequently, a second section with a width of 1.5 meters was added, considering the incline angle of the first section. Finally, the last section of the buttress was designed with a width of 12 meters. The modelling of the dam was carried out using the DIANA FEA program, which provided specifications for each material used in the construction process. These specifications are presented in Table 2. All relevant design considerations were considered when selecting the slenderness ratio massiveness factor, and plotting a suitable master curve. The dam's height measures 58 meters, with a maximum water level of 55 meters. This level represents the highest observed water level in natural conditions at Khassa Chai. Additionally, a freeboard of 3 meters is incorporated, which minimizes the possibility of an uncontrolled release of water or tailings on the dam. This aspect holds significance due to its ability to mitigate potential adverse social and environmental consequences upstream of the impoundment, as mentioned in the provided reference[21].

Table 3: The characteristics of the dam, foundation, and reservoir

Properties Material	Density Kg/m <sup>3</sup>	The young modulus N/m <sup>2</sup>	The ratio of Poisson	Specification of Mass density	Material class
Dam	2400	3.2e+10	0.2	-	Concrete and masonry
Foundation		8e+09	0.2	Saturated density	Soil and rock
Reservoir	1000	-	-	-	-

The dam is partitioned into two sections: a frontal surface, a level panel measuring 3 meters in thickness, and inclined at an angle of 50 degrees. The range of inclination angles observed is between 40 and 50 degrees. It is noted that a lower angle of inclination

is preferable as it enhances the structure's ability to withstand the hydrodynamic forces originating from the upstream direction.[12]The dam's rear section comprises three distinct components, namely the buttress. The first segment measures 46 meters in width and 55 meters in height and is situated beneath the frontal slab. The second component, the insulation wall, is 1.5 meters wide and 58 meters high and houses a drainage gallery. The third and final section is characterized by a

base width of 12 meters and a height of 58 meters, with all pillars measuring 4.5 meters in thickness. Stability calculations were conducted for all anticipated loading conditions as outlined [12], and the test results are presented in Table (3) below

It is crucial to note that the foundation type adopted for the dam is of the isolated footing variety, which effectively mitigates the impact of foundation settlement pressures, reducing the uplift pressure effect.

**Table 4:** Factor of safety for Load combinations for stability analysis

Load combination	FSO	FSS	FFS	Notes
Normal Operating condition	3.67	1.67	2.82	Full reservoir elevation, normal dry weather tail water, normal uplift, ice and silt (if applicable).
Flood discharge condition	3.89	1.45	2.61	Reservoir of maximum flood pool elevation, all gates are opened, tail water at flood elevation, normal uplift and silt (if applicable).
Normal operating with earthquake	3.4	1.4	2.7	Normal operating with earthquake.

### 3.2 Results of Optimization

Some potential optimal solutions have been identified after using the genetic algorithm in MATLAB and their settings as mentioned earlier in the optimization process. Each of these solutions presented a novel form for the design of the concrete buttress dam.

#### 3.2.1 Buttress dam model with optimal parameters:

A range of potential optimal solutions emerged after implementing the optimization process utilizing the Genetic Algorithm within MATLAB along with the pre-defined parameters. Each of these solutions introduced novel dimensions for

the buttress dam design. Out of the pool of solutions, fifteen models were carefully selected based on their alignment with the dam's structural requirements, while the remaining samples were disregarded. Subsequently, the most effective configuration among these 12 samples underwent a comprehensive analysis utilizing the finite element method via the Diana program. This analysis was conducted to assess the adherence of the chosen design to stress constraints. The outcomes of this analysis revealed a noteworthy observation: in all instances, the maximum stress levels remained well below the permissible stress limits. This outcome signifies the success and feasibility of all the considered samples. However, the ultimate aim was to achieve a configuration that minimized volume and stress.

**Table 5.** Models of the optimal shape of the buttress dam selected by genetic algorithms

Samples	X1	X2	X3	concrete volume $m^3$	Reduction ratio
1	11	1.1	2.1	9632.7	49.692%
2	11	1	2	9501.0	50.379%
3	10.8	1	2	9474.9	50.516%
4	10.6	1.1	2.2	9686.1	49.413%
5	10.4	1	2.1	9528.3	50.237%
6	10.2	1	2	9396.6	50.925%
7	10	1	2	9370.5	51.061%
8	9.5	1.1	2.5	9859.36	48.508%
9	8.5	1.1	2.5	9728.85	49.189%
10	7.5	1.3	2	9122.55	52.356%
11	6.8	1.5	2.1	9189.0	52.009%
12	7	1.5	2.1	9215.1	51.873%

The selection of models was based on their appropriateness for the shape of the dam while disregarding other samples. One of the samples above is selected based on having the smallest dam volume and stresses. Each of these solutions presented a novel form for the design of the concrete buttress dam. It is important to mention that for each model selected in Table above the stability of the dam was checked through the constraint function, which means checking FSO and FSS. The value of FFS was also checked and calculated.

Concrete is lowered from the initial design  $19147.5m^3$  to the final design  $9122.55 m^3$  due to the shape's optimal volumetric qualities. This is what the optimization process is trying to achieve. through a previous table, it was found that a sample shows that a percentage reduction in the size of Concrete amounted to 52.356% of the total size in a conventional design.

**Table 6.** Comparing the amount of reduction in dimensions after the optimization process

Design variable	initial dimensions	Optimum dimensions	Reduction %
$X_1$	12m	7.5m	37.5%
$X_2$	1.5m	1.3m	13.33%
$X_3$	3m	2m	30%
Total volume	$19147.5m^3$	$9122.55 m^3$	52.356%

In Figure (8) a reduction can be seen in the dam's cross-section, indicating a decrease in the amount of Concrete. The optimal fitness plot, a graphical representation that illustrates the highest fitness value achieved in each generation of a genetic algorithm, was plotted against the corresponding iteration number. The iteration number refers to the count of complete cycles that the genetic algorithm has executed across its entire population. From Figure (9) it is noted that there are numbers of best fitness in the diagram after 66 iterations in GA (It represents the number of attempts to reach the best solution and is automatically selected in a genetic algorithm); The last value has been reached ( $9122.55m^3$ ) in the down is chosen because It represents the best fitness This is the individual that has the highest fitness value, according to the fitness function.

also, a mean fitness value ( $9122.55m^3$ ) refers to the average fitness value of all individuals in the current population. This measures how well the population is doing as a whole.

The expectation plot presented in Figure(10) is a graphical representation that illustrates the expected quantity of offspring about the raw scores for each iteration of a genetic algorithm. The raw scores represent the fitness values of the individuals within the population. The utilization of this plot serves as a valuable instrument for comprehending the process by which the genetic algorithm effectively determining and selecting individuals for reproduction. Examining the algorithm's prioritization of individuals with

elevated fitness values can be beneficial. As the raw scores increase, there is an observed increase in the expected number of children. This implies that the genetic algorithm prioritizes individuals with superior fitness values for reproduction.



Figure 8. Traditional and improved design of case study dam.

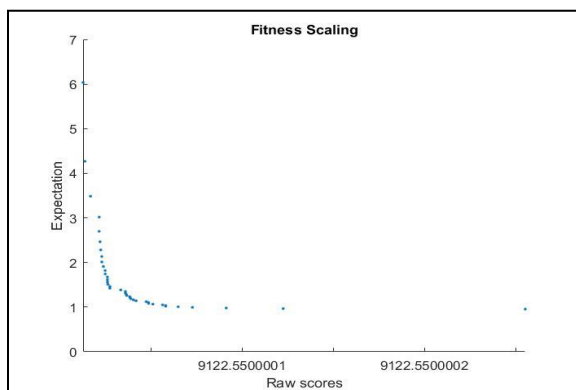

Figure 9. Best Fitness plot in GA

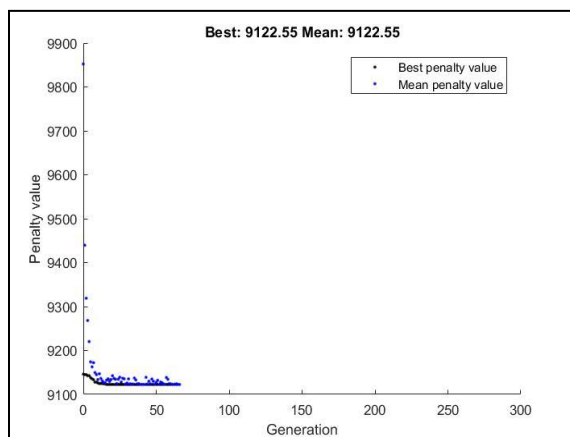

Figure 10. Expectation plots for children versus the raw

#### 4. Conclusion:

The main goal of this paper was to access optimum design of a buttress dam by controlling different shape parameters; result has demonstrated that using the (GA) tool in the MATLAB software is an effective approach to obtaining an optimal design for concrete buttress dams to decrease the total volume of Concrete and the construction cost, Design variables include a triangular portion of the buttress at the downstream of the dam, which has reduced by 37.5%, As well as the medial part of the buttress, which has decreased to 13.33%, and width of deck slab of the dam which also reduced 30%, Due to the shape's superior volumetric properties, it was capable to reduce the required volume of Concrete from 19147.5m<sup>3</sup> in the original design to 9122.55m<sup>3</sup> in the final design. The optimization procedure aims to do this: the total reduction was 52.356% in concrete volume, so GA was a versatile approach for optimization and possibly optimal structural design. It is important to mention that the reduction in the volume paired with allowed stresses. It is noted that the maximum stresses in the optimization solutions were below the allowable limit.

#### 5. Acknowledgment

I would like to particularly acknowledge and thank my supervisor for giving me this opportunity to complete this excellent project on optimizations, which also enabled me to conduct a great deal of research and learn about many new topics. My knowledge and abilities significantly increased as a result.

#### References

- [1] H. Bersini and G. Seront, "In search of a good evolution optimization crossover," in *the 2nd Conference on Parallel Problem Solving from Nature*, 1992, pp. 479–488.
- [2] M. M. Silvano, E. M. R. Fairbairn, M. Asce, R. D. T. Filho, N. F. F. Ebecken, and J. L. D. Alves, "Optimization of Dam Construction Costs Using," in *Concrete*, 2003, pp. 154–161.
- [3] L. S. Sun and F. Du, "Robust optimization for shape design of arch dams based on strain energy," in *Applied Mechanics and Materials*, 2015, vol. 777, pp. 94–100.
- [4] S. Pourbakhshian, M. Ghaemian, and A. Joghataie, "Shape optimization of concrete arch dams considering stage construction,"

- Sci. Iran.*, vol. 23, no. 1, pp. 21–35, 2016, doi: 10.24200/sci.2016.2094.
- [5] J. Akbari, M. T. Ahmadi, and H. Moharrami, “Advances in concrete arch dams shape optimization,” *Appl. Math. Model.*, vol. 35, no. 7, pp. 3316–3333, Jul. 2011, doi: 10.1016/j.apm.2011.01.020.
- [6] A. A. H. S. and . N. W. awaid A., “Optimum Analysis and Design of Curved Concrete Dams,” *Iraqi J. Civ. Eng.*, vol. 11, no. 3, pp. 32–51, 2017, doi: 10.37650/ijce.2017.172892.
- [7] L. J. Araujo, A. Vieira, and D. Gutstein, “Optimization study for the cross-section of a concrete gravity dam: Genetic algorithm model and application,” *Rev. Int. Metod. Numer. para Calc. y Disen. en Ing.*, 2019, doi: 10.23967/j.rimni.2019.06.002.
- [8] Y. Q. Wang, R. H. Zhao, Y. Liu, Y. Z. Chen, and X. Y. Ma, “Shape optimization of single-curvature arch dam based on sequential Kriging-genetic algorithm,” *Appl. Sci.*, vol. 9, no. 20, p. 12, Oct. 2019, doi: 10.3390/app9204366.
- [9] S. Gholizadeh and S. M. Seyedpoor, “Shape optimization of arch dams by metaheuristics and neural networks for frequency constraints,” *Sci. Iran.*, vol. 18, no. 5, pp. 1020–1027, 2011.
- [10] A. H. Kadoury, *MEAN RAINFALL IN KHASA CHAI CATCHMENTS*. 2005, p. 16.
- [11] J. Zhou, A. Nekouie, C. A. Arslan, B. T. Pham, and M. Hasanipanah, “Novel approach for forecasting the blast-induced AOp using a hybrid fuzzy system and firefly algorithm,” *Eng. Comput.*, vol. 36, no. 2, pp. 703–712, 2020, doi: 10.1007/s00366-019-00725-0.
- [12] J. Zhou, C. Li, C. A. Arslan, M. Hasanipanah, and H. Bakhshandeh Amnieh, “Performance evaluation of hybrid FFA-ANFIS and GA-ANFIS models to predict particle size distribution of a muck-pile after blasting,” Springer London, 2021. doi: 10.1007/s00366-019-00822-0.
- [13] Shashi Kumar Sharma, *Irrigation Engineering and Hydraulic Structures*, 4th ed. NEW DELHI: S Chand & Co Ltd, 2017.
- [14] C. Darwin, *ENGINEERING GUIDELINE FOR THE EVALUATION OF HYDROPOWER PROJECTS*, vol. XXX. England, 1991.
- [15] Chaoran Fu and Bjartmar Porri Hafliadason, “Progressive failure analyses of concrete buttress dams,” 2015. [Online]. Available: <https://www.diva-portal.org/smash/record.jsf?pid=diva2:824952>
- [16] T. Bäck, *Evolutionary Algorithms in Theory and Practice*. Oxford University Press, 1996. doi: 10.1093/oso/9780195099713.001.0001.
- [17] J. H. (John H. Holland and J. H., *Adaptation in natural and artificial systems : an introductory analysis with applications to biology, control, and artificial intelligence*. Ann Arbor SE -: University of Michigan Press Ann Arbor, 1992. doi: LK - <https://worldcat.org/title/1531617>.
- [18] J. L. Torres and N. B. Linsangan, “Application of Genetic Algorithm for Optimization of Data in Surface Myoelectric Prosthesis for the Transradial Amputee,” *Int. J. Inf. Educ. Technol.*, vol. 5, no. 2, pp. 113–118, 2015, doi: 10.7763/ijiet.2015.v5.486.
- [19] S. N. Sivanandam and S. N. Deepa, “Genetic Algorithms BT - Introduction to Genetic Algorithms,” S. N. Sivanandam and S. N. Deepa, Eds. Berlin, Heidelberg: Springer Berlin Heidelberg, 2008, pp. 15–37. doi: 10.1007/978-3-540-73190-0\_2.
- [20] Santosh Kumar Garg, *Irrigation Engineering And Hydraulic Structures*, vol. 20, no. 1. 1986. doi: 10.1201/b19987-15.
- [21] G. Sachdeva, S. Chakraborty, and S. Ray-Chaudhuri, *Seismic response control of a structure isolated by flat sliding bearing and nonlinear restoring spring: Experimental study for performance evaluation*, vol. 159. 2018. doi: 10.1016/j.engstruct.2017.12.033.