

Fuzzy Logic Controller Based DVR For Power Quality Improvement under Different Power Disturbances with Non-Linear Loads

Abdul-Jabbar Fathel Ali

Electrical Engineering Depart.

Wasit University

Kut, Iraq

AJF_572@yahoo.com

Wael Hussein Zayer

Electronic Depart.

Southern Technical University

Amara, Iraq

wael.zayer@stu.edu.iq

Samhar Saeed Shukir

Electrical Engineering Depart.

Middle Technical University

Kut, Iraq

samharalwandi@gmail.com

Abstract: The power quality problems can be defined as the difference between the quality of power supplied and the quality of power required. Recently a large interest has been focused on a power quality domain due to: disturbances caused by non-linear loads and Increase in number of electronic devices. Power quality measures the fitness of the electric power transmitted from generation to industrial, domestic and commercial consumers. At least 50% of power quality problems are of voltage quality type. Voltage sag is the serious power quality issues for the electric power industry and leads to the damage of sensitive equipments like, computers, programmable logic controller (PLC), adjustable speed drives (ADS). The prime goal of this paper is to investigate the performance of the Fuzzy Logic controller based DVR in reduction the power disturbances to restore the load voltage to the nominal value and reduce the THD to a permissible value which is 5% for the system less than 69Kv. The modeling and simulation of a power distribution system have been achieved using MATLAB/Simulink. Different faults conditions and power disturbances with linear and non-linear loads are created with the proposed system, which are initiated at a duration of 0.8sec and kept till 0.95sec.

Index Terms—Power quality improvement, Dynamic voltage restorer, fuzzy logic controller, and power quality problems.

I. INTRODUCTION

Power quality is a set of parameters that define the characteristics of the power supply as delivered to the consumers in normal operating conditions in terms of continuity of supply and characteristics of voltage such as, frequency, magnitude, waveform and symmetry [1]. Power quality is not only a technical problem but also a problem that leads to financial losses. Many surveys have been shown that poor power quality causes large economic losses to industrial sectors and large amount of power is wasted due to poor power quality in the services. A survey conducted on industrial sector in India that the poor power quality and operating conditions related to downtime lead to losses of estimated ten billion USD[2]. Power quality events are unpredictable but they can be anticipated. Identifying the exact problem requires sophisticated electronic testing equipments but the symptoms such as, automated system stopping for

no apparent reason, equipment failure during lightning and thunder storm, electronic system failure on a frequent basis, tripping of circuit breakers without being overloaded, and working of electronic system in one location but not in another location help us to identify the power quality problems [3]. Power quality is a combination of voltage and current quality. In most cases the utility is responsible for voltage quality at the point of common coupling (PCC) while the consumers often influence the current quality at the PCC. There is always a relationship between the voltage and the current in any practical power system. Voltage sag and harmonics are the most common power quality problems in the industrial process. The voltage sag is the main power quality problem for the manufacturing industries and telecom sectors. Harmonics problems are perceived especially by the service sectors such as hospitals and banks. Several types of power improvement devices have been developed to protect equipment

from power problems, but the efficient and effective devices are Custom power devices which are able to provide customized solutions to power quality variations. The notion of custom power devices is using power electronic controllers in the power systems to supply high quality power and reliable that is needed for the sensitive equipments. DVR is efficient and effective to compensate large voltage variations due to its lower cost, smaller size and dynamic response. It uses for mitigating the power disturbances, load balancing, and active filtering. The first DVR in the world was installed in the USA in the year 1996 . It was engineered by Electrical Power Research Institute . This DVR was installed at the medium voltage level of 12kV and rated for 2MVA[4]. Dynamic Voltage Restorer is a fast, efficient and flexible custom power device inserted in the system between the source and the critical load through a booster transformer to compensate any power disturbances affecting the load voltage. Three-level inverter is proposed in this work to obtain high power and low harmonics at the output of the inverter. Fuzzy logic controller for the DVR Prove that it is effective and powerful in eliminating the power quality problems because that the Inverter in the DVR is non-linear and needs a non-linear controller[5]. The performance of the DVR based on Fuzzy Logic control to enhance the power quality under different power disturbances is presented in this paper.

II. POWER QUALITY PROBLEMS

Power quality problems, effects and causes will be discussed in the following section:

A. Voltage sag

A sag is a sudden decrease in the r.m.s voltage that the voltage value becomes between 10% and 90% from nominal value, and keeps from 0.5 cycle to several seconds. Sag with duration of less than 0.5 cycle are regarded as transients. Voltage sag either symmetrical or unsymmetrical, in symmetrical sag all three phase voltage are reduce in the same value, and this occurs in a three phase fault as shown in Fig.1. While double line to ground fault and single line to ground fault are produced unsymmetrical sag as shown in Fig.2

B. Harmonics

Harmonics are spectral components with frequencies equal to multiplies of the base frequency as shown in Fig.3, the 2nd order and 3rd order harmonics are presence with the fundamental frequency waveform. The main cause of harmonics voltage distortion is the nonlinear loads. There are also several factors that contributing to the voltage harmonics such as [6]:

- 1-The voltage generated by synchronous generators are not exactly sine wave due to the deviation from an ideal form of generators.
- 2- The electrical power transmitted from the generating stations to the load is not completely linear for a number of reasons, most notably nonlinear power transformers due to the saturation of magnetic flux in the iron core of the transformer.
- 3-Transformation from AC voltage to DC voltage and vice versa occur using power electronic components. Table.1 shows voltage distortion limits according to IEEE standard 519.

C. Voltage swell

Swell is a sudden increase in the r.m.s voltage that its value becomes between 110% and 190% from nominal value, and keeps from 0.5 cycle to several seconds. Swells with duration of less than 0.5 cycle are regarded as transients. The main causes of swell are, energizing a large capacitive bank or switching off a large inductive loads. Fig.4 shows a waveform depicting a voltage swell.

D. Voltage interruptions

The voltage is decreased to less than 0.1pu for a period not exceeding 1 min. The interruptions mainly due to equipments failure in the electrical system, storms, fire, objects (cars, trees, etc), striking poles or lines, and human error. Voltage interruptions is shown in Fig.5.

E. Voltage transient

Transient is a sudden change in steady state conditions of voltage, current, frequency or all for a period less than one cycle. The main reason for the case of the transient is the energizing and switching off a large sources or loads in electrical power network. Fig.6 shows the status of the transient.

F. Asymmetrical voltage

Asymmetrical voltage occurs when the values of individual phase voltages are not equal in magnitude or the phase difference between these voltages is not equal 120 degree. Asymmetrical voltage occurs due to a large single loads such as induction furnaces and unbalance loading for the individual phase voltages. Fig.7 shows the status of Asymmetrical voltages Among all the problems of power quality, the voltage sag problem is the biggest risk and most common problem in electrical systems so its causes and effects will be discussed in detail.

III. Causes of voltage sag

A. Voltage sag due to faults

The main cause of the sag is the power system faults. The type of sag depends on the nature of fault and its location. The fault near a distribution substation causes all the customers connected to this station will face a deep sag. The main reasons for failure of the power system are: interference from birds and smaller animals and weather (wind, lightning, snow)[7].

B. Recloser of circuit breaker

The operation or recloser the circuit breaker in a specific line leads to temporary disconnection in this line. If the grid is weak , this temporary disconnection will cause to occur a sag in all the feeders adjacent to this line. The extent of this sag depends on the distance from the source and the distance from the fault.

C. Energizing the transformers

When several transformers are energized at the same time, a high current flows that leads to a drop in the voltage which is experienced by the customers in the entire area.

D. Starting of induction motors

The induction motors take a high current at the start of about six times the normal current. This high current leads to a drop in voltage depending

on the parameters of the power system and the induction motor specifications.

IV. Effects of voltage sag

Voltage sag problems in industrial equipments include [8]:1-Relays opening due to the sag affecting relay's coil voltage. 2-Make voltage sensors in power systems operate unnecessarily.

3-Incorrect reports from sensors such as, water pressure sensors and air flow sensors. 4-Fuses or circuit breaker operating due to a large increase in current after the sag.

V. Power Quality Improvement Techniques and Solutions

Several types of power improvement devices have been developed to protect equipment from power problems, but the efficient and effective devices are custom power devices which are able to provide customized solutions to power quality variations. The notion of custom power devices is using power electronic controllers in the power systems to supply high quality power and reliable that is needed for the sensitive equipments. The custom power devices can be classified into two categories: Network Reconfiguring type and Compensating type.

Network Reconfiguring type protects the sensitive loads by:

- Avoid interruption, voltage sag and swell by connecting healthy feeder.
- Disconnects the fault circuits
- Limits fault current by quickly inserting a series inductance in the fault path

The compensating type is used for load balancing and active filtering, power factor correction, and voltage regulation. Compensating type are Dynamic Voltage Restorer (DVR) , Unified Power Quality Conditioner (UPQC) and Distributed Static Compensator (DSTATCOM).

VI. Dynamic Voltage Restorer (DVR)

Series device is efficient and effective to compensate large voltage variation by voltage injection. It used for mitigating the power disturbances.

VII. The basic structure of the DVR

Fig.8 shows the basic structure of the Dynamic Voltage Restorer.

The power circuit of the DVR consists of five main parts, energy storage unit, inverter circuit, pulse width modulation (PWM), passive filter, and series injection transformer.

VIII. Fuzzy Logic Controller Based Dynamic Voltage Restorer

Currently, Fuzzy Logic controller plays an important role in practical applications, there are a large number of products in the markets (mostly designed in Japan) which used Fuzzy Logic control. Yasunobu and Miyamoto at Hitachi designed a fuzzy logic controller for an Automatic train control (ATO) system which operating in Japan since July 1978 until now where two systems are used the fuzzy logic controller are the system to control the constant speed (CSC) and the automatic stop control (ASC)[9]. Another example of the use of Fuzzy Logic is the wireless control of unmanned aircraft using oral instructions used to guard the sea[10]. These and other applications demonstrate the strength of the FL control technology. FL controller are an appropriate choice when mathematical formulations are tedious. The using of FL controller will reduce a tracking error and a transient overshoot of PWM. The performance of the FL controller depends on the knowledge and expertise of the designer[11]. FL controller is preferred to the PI controller because of the accurate mathematical formulations model is not required and its robustness to system variation during operation. FL controller is one of the most successful operations of fuzzy set theory. It uses the linguistic variables rather than numerical variables. FL provides a simple way based on vague, ambiguous, noisy, imprecise, or missing input information. This controller based on the capability to understand the system behavior and it relies on quality control rules[12]. In this paper FL controller is used for controlling the voltage injection of the DVR.

IX. The Construction of Fuzzy Logic Controller

The general structure of the FLC as shown in Fig.9 consists of five principle components, namely: fuzzification interface, inference mechanism, defuzzification interface, rule base and knowledge base [13].

A. Fuzzification

It converts a crisp input signal, error and change of error into fuzzified signal that can be quantified by level of memberships in the fuzzy set.

B. Inference mechanism

It infers the fuzzy control action from the knowledge base and rule base to convert the input conditions to fuzzified output.

C. Defuzzification interface

It converts the fuzzified output to crisp control signal using the output memberships function, which acts in the system as the change in the control input. In this paper centroid method is used for defuzzification.

D. Rule base

It consists of a set of linguistic rules which change the fuzzified input to the desired output.

E. Knowledge base

It consists of data base with linguistic definitions and rule base. Data base composed of input and output membership functions and provides the necessary information for fuzzification and defuzzification operations.

X. The Membership Functions

There are a large number of functions which can be used for different applications [14].

A. Triangular membership function

It is piecewise-linear function, which is often used in applications. Operations and graphical representations with this fuzzy sets are very simple. It can be constructed depending on little information.

A triangular membership function A with endpoints (a,0) and (b,0), (c,α) is the high point and α is the cut set. Fig.10 shows the triangular function Is defined by:

$$A(x) = \begin{cases} \alpha \left(\frac{x-a}{c-a} \right) & \text{if } a \leq x \leq c \\ \alpha \left(\frac{x-b}{c-b} \right) & \text{if } c \leq x \leq b \\ 0 & \text{otherwise} \end{cases} \text{-----(1)}$$

B. Trapezoidal membership function

It is like triangular function, simple, linear, needs a little information, its graphical representation and operations is very simple.

The trapezoidal membership function with end points, (a,0) , (b,0) and high points (c,α) , (d,α) as shown in Fig. 11

Is defined by

$$A(x)=\begin{cases} \alpha \left(\frac{x-a}{c-a}\right) & \text{if } a \leq x \leq c \\ \alpha & \text{if } c \leq x \leq d \\ \alpha \left(\frac{x-b}{d-b}\right) & \text{if } d \leq x \leq b \\ 0 & \text{otherwise} \end{cases} \quad \text{--- (2)}$$

C. Gaussian functions

It has useful mathematical properties. Fig.12 shows the Gaussian membership function

It is defined by: $A(x) = e^{-\frac{(x-c)^2}{2\sigma^2}}$ -----(3)

The parameters c and σ determine the shape and the center of the curve respectively. When c=0 and σ=1 the gaussian function is called the standard gaussian which centered at c=0 and the area under the curve is equal to $\sqrt{2\pi}$.

D. S- and Z- functions

These are the sigmoid functions as shown in Fig.13 and Fig.14, and they defined by the following equations;

S-function $A(x) = \frac{1}{1+e^{-x+1}}$ -----(4)

Z – function $A(x) = \frac{1}{1+e^{x-1}}$ -----(5)

XI. The input and output membership function and the set of the linguistic rules for the fuzzy Logic controllers

The input and output membership functions for the first controller are shown in figures 17,18,19. Table.2 shows the 20 linguistic rules for the first controller.

The input and output membership functions for the second controller are shown in figures 20,21 and the rules set which is 9 rules are demonstrated in table.3

XII. Modeling and simulation

The control system of the DVR based on Fuzzy Logic controller is depicted in Fig.22

Fig.23 shows the non-linear loads have been connected to the electrical power source. Double tuned filter which has been connected at the second feeder helps the DVR in mitigating the THD under non-linear loads . The efficiency and

the capability of the fuzzy logic controller based DVR have been demonstrated by the simulation results under different power disturbances which are simulated for a periode of 0.15s from 0.8s and kept till 0.95s.

The parameters of the electrical power system are demonstrated in table.4

The simulation results below show that the DVR with the double tuned filter is effective and efficient in restoring the load voltage to the normal form and mitigating the THD to a permissible values

XIII. The Total Harmonic Distortion(THD) levels of the load voltage

The Total Harmonics Distortion is an important indication used for analyzing the power quality.

The definition of THD is given by

$$THD_{Vp} = \frac{\sum_{n=2}^{n=\infty} V^2_{pn}}{V_{p1}}$$

Where, p is the phase order and n is the harmonic order.

The THD can be calculated as follows:

$$THD = \frac{THD_{va} + THD_{vb} + THD_{vc}}{3}$$

DVR reduces the THD from a high value to an acceptable value as indicated in table.5.

XIV. Conclusions

This paper deals with mitigating the power quality problems such as sag, swell, and harmonics. The custom power devices are used to enhance power transfer capabilities and stability margins of a transmission line. Dynamic Voltage Restorer is one of the most effective and efficient custom power devices due to the smaller size, lower cost , and the dynamic response. DVR can solve the voltage disturbances to protect the sensitive load in distribution system. Most of the researchers applied the control strategies to compensate the voltage disturbances in critical load but did not focus on the objective of reducing the total harmonics distortion (THD) . In many sensitive loads such as, airport lighting system, medical equipment, auxiliary plant of power system, and adjustable speed drives. The level of (THD) is more important, this paper focuses on harmonics mitigation to less than 3% and voltage compensation in evaluating the performance of the

Dynamic Voltage Restorer using fuzzy logic controller method with linear and non-linear loads. From the simulation results obtained, it can be concluded that , the Double tuned filter which tuned at the 5th and 7th harmonics with a value of Q=1.25MVAR is used under non-linear loads to help the DVR in compensating the required voltage for improving the power quality under different voltage variations. The performance of the Fuzzy Logic controller is more best with non-linear loads compared with its function with linear loads since it depends on the non-linear equations, it is the most efficient in enhancing the performance of the DVR in compensating any kind of power disturbances and reducing the voltage THD by improving the injection capability which is highly affected by the control algorithm employed.

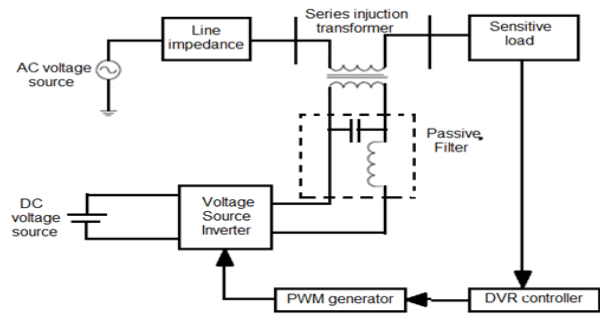

Fig.8 The basic structure of the DVR

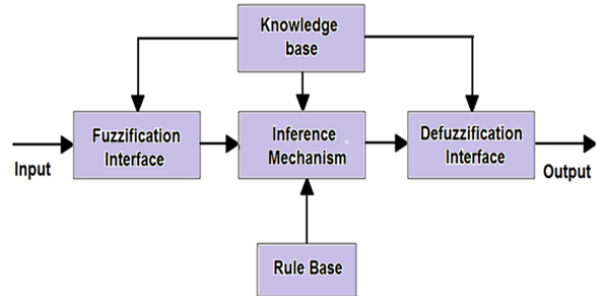

Fig.9 : The structure of the Fuzzy Logic controller

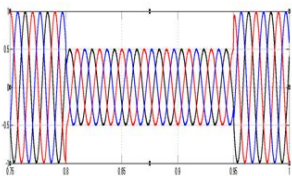

Fig.1: Symmetrical voltage sag due to three phase to ground fault

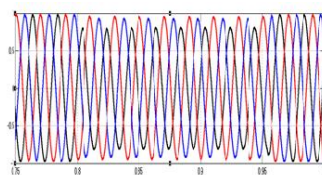

Fig.2: Unsymmetrical voltage sag due to Single line to ground fault

Table.1: Voltage distortion limits for harmonics

Bus voltage	Total harmonic distortion (%) for individual voltage	Total harmonic distortion(%) for three-phase voltage
$V < 69 \text{ kV}$	3.0	5.0
$69 \leq V < 161 \text{ kV}$	1.5	2.5
$V \geq 161 \text{ kV}$	1.0	1.5

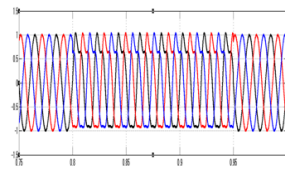

Fig.3: Harmonics voltage

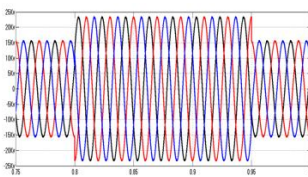

Fig.4: Voltage swell

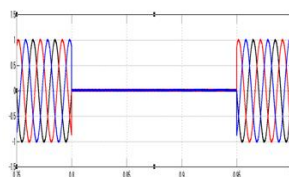

Fig.5: Voltage interruptions

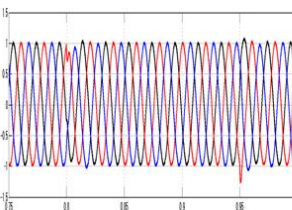

Fig.6: Voltage transient

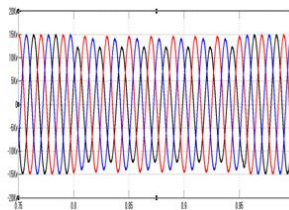

Fig.7: Asymmetrical voltage

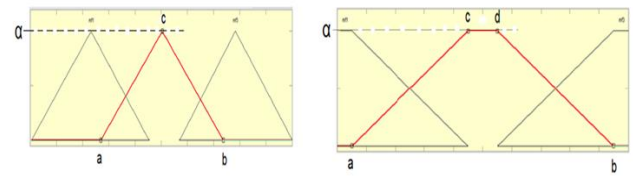

Fig.10: The triangular membership function

Fig.11: The trapezoidal membership function

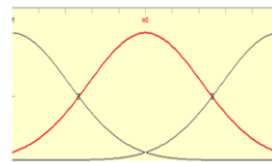

Fig.14: The Gaussian function

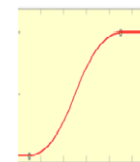

Fig.15: The S-function

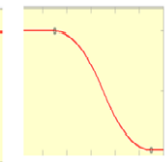

Fig.16: The Z-function

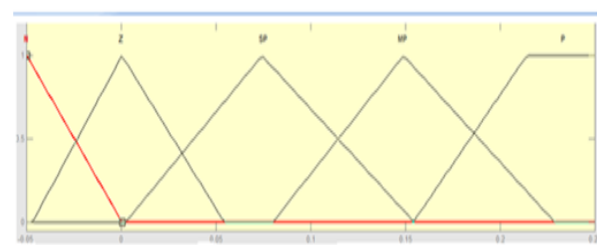

Fig.17: The input membership function of error for the first controller

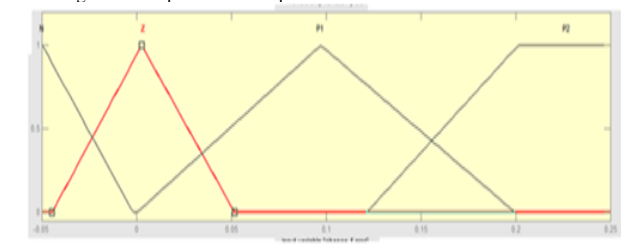

Fig.18: The input membership function of the change of error for the first controller

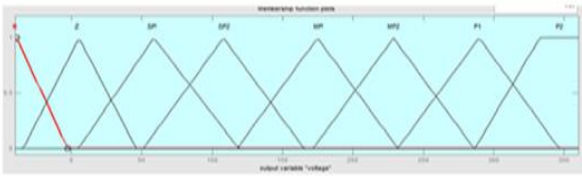

Fig.19: The output membership.

Table.2: The set of linguistic rules for the first controller

Δe \ e	N	Z	P1	P2
N	N	N	N	N
Z	Z	Z	Z	Z
SP	SP1	SP1	SP2	SP2
MP	MP1	MP1	MP2	MP2
P	P1	P1	P2	P2

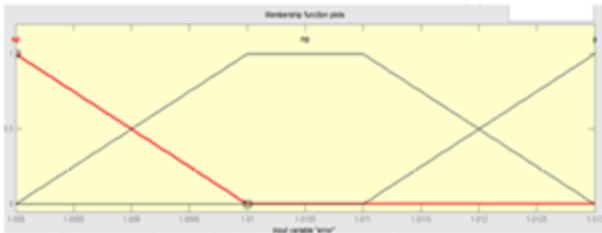

Fig.20: The input membership function of the error and change of error for the second controller

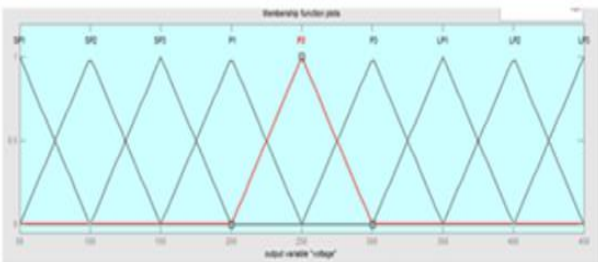

Fig.21: The output membership function for the second controller.

Table.3: The set of linguistic rules for the second controller

Δe \ e	SP	MP	P
SP	SP1	SP2	SP3
MP	MP1	MP2	MP3
P	LP1	LP2	LP3

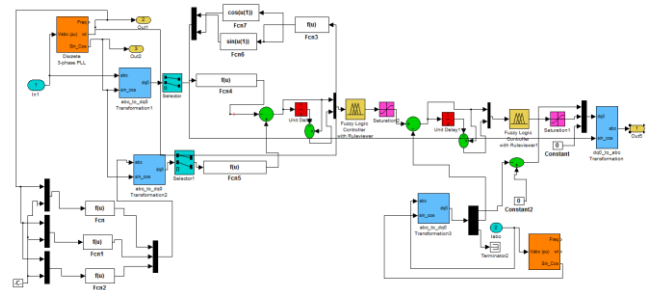

Fig.22: Modeling and simulation the control system of the DVR based on Fuzzy Logic controller

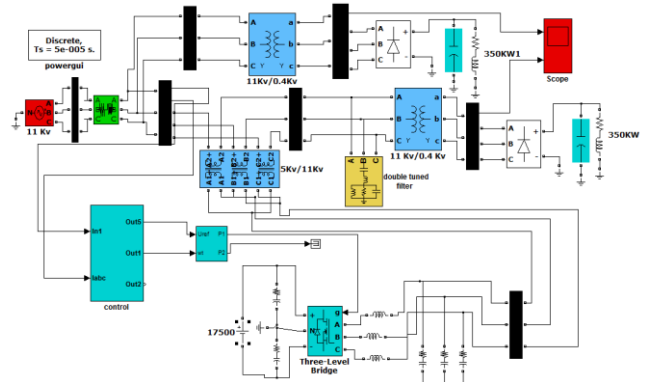

Fig.23: The modeling and simulation of the system with DVR using three phase programmable source with non-linear loads

Table.4: The parameters of the electrical power system

The parameters of the electrical power system	The values of the parameters
The voltage source	11kV _{r.m.s} ,50Hz
The transformer of the load	11000/400 V _{r.m.s} , 350KVA
The DC source	17500v
The active filter	100μF, 300mH
The injection transformer	5000/11000V _{r.m.s} , 3MVA
The electrical load	350KW, 50Hz, 400v
The fault resistance	0.001 ohm
The ground resistance	0.001 ohm
Double tuned filter	Tuned at 5 th and 7 th harmonics, Q=1.25MVAR

Case-1: (50%) Sag

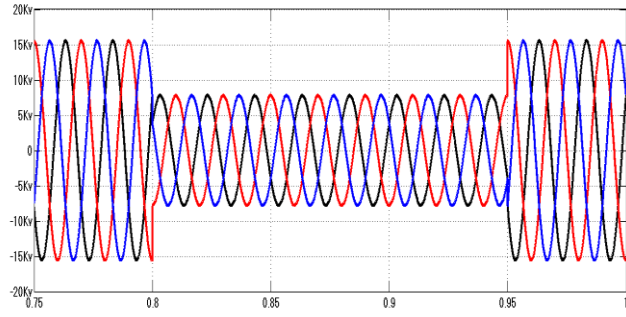

Fig.24: The load voltage at the first feeder (without DVR)

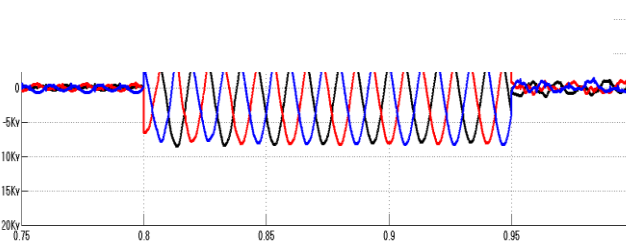

Fig.25: The injection voltage by the DVR

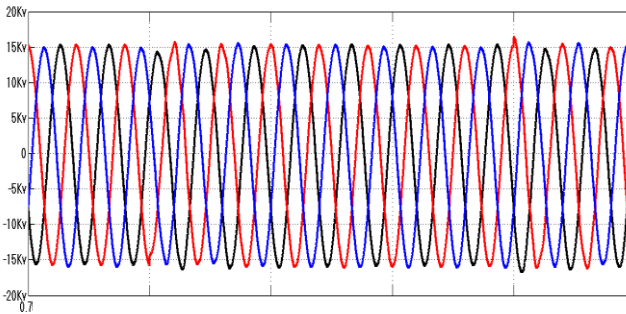

Fig.26: The load voltage at the second feeder (with DVR)

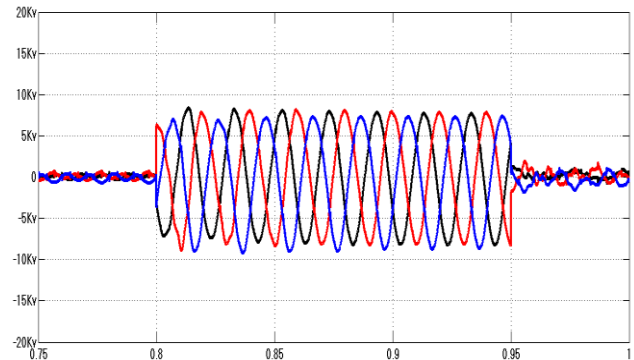

Fig.28: The injection voltage by the DVR

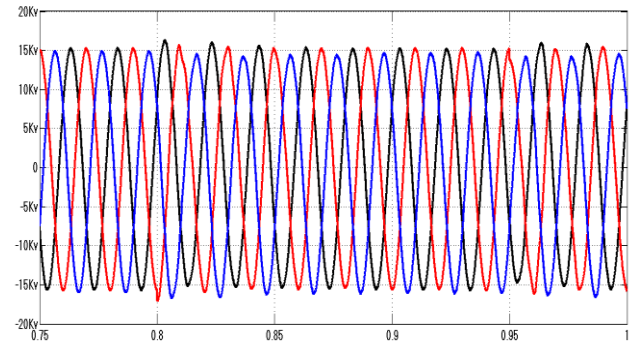

Fig.29: The load voltage at the second feeder (with DVR)

Case-3: Voltage interruption

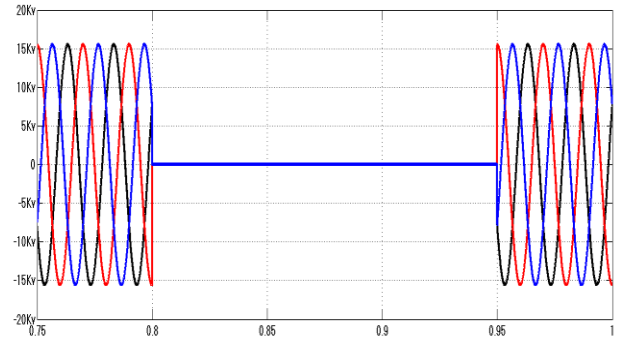

Fig.30: The load voltage at the first feeder (without DVR)

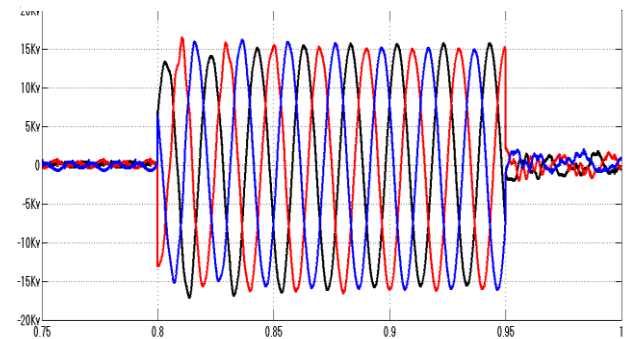

Fig.31: The injection voltage by the DVR

Case-2: 150% Swell

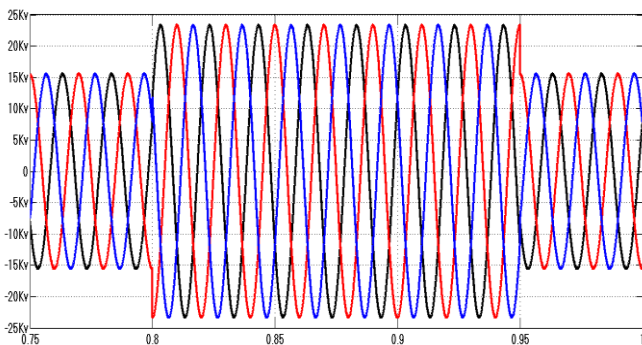

Fig.27: The load voltage at the first feeder (without DVR)

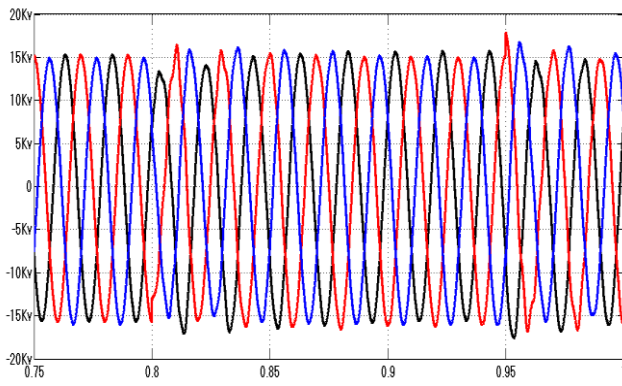

Fig.32: The load voltage at the second feeder (with DVR)

Case-5: Source voltage with 3rd and 4th harmonics

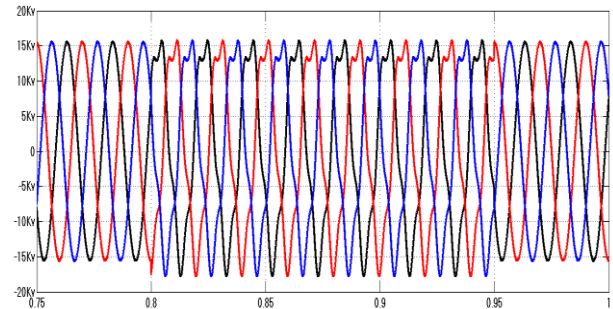

Fig.36: The load voltage at the first feeder (without DVR)

Case-4: Source voltage with 2nd and 3rd harmonics

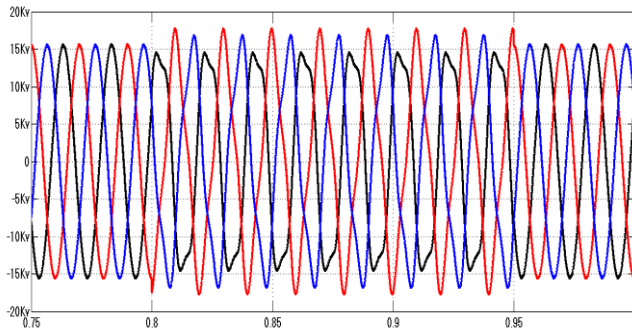

Fig.33: The load voltage at the first feeder (without DVR)

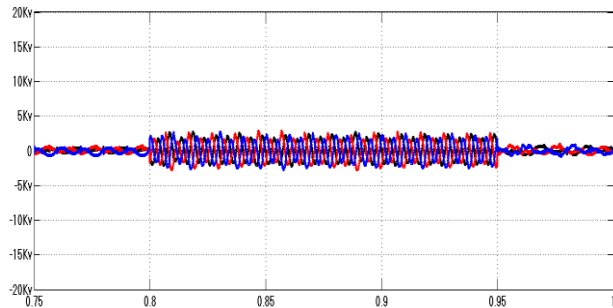

Fig.37: The injection voltage by the DVR

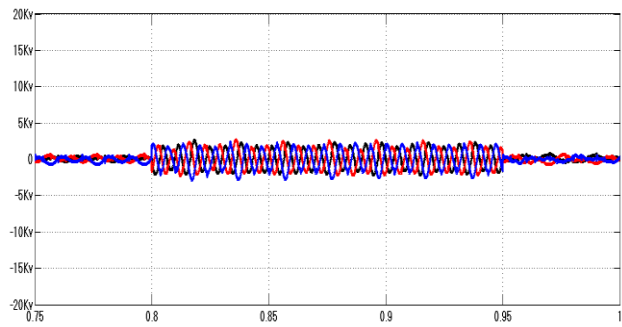

Fig.34: The injection voltage by the DVR

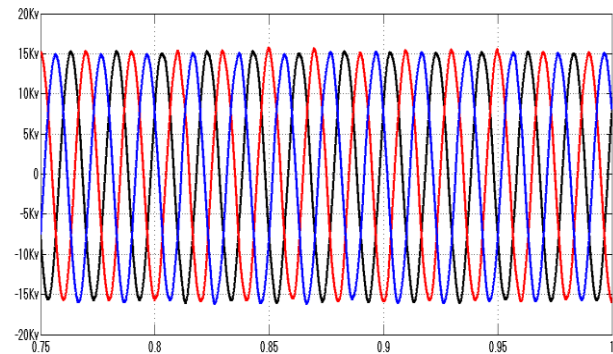

Fig.38: The load voltage at the second feeder (with DVR)

Case-6: Source voltage with 5th and 7th harmonics

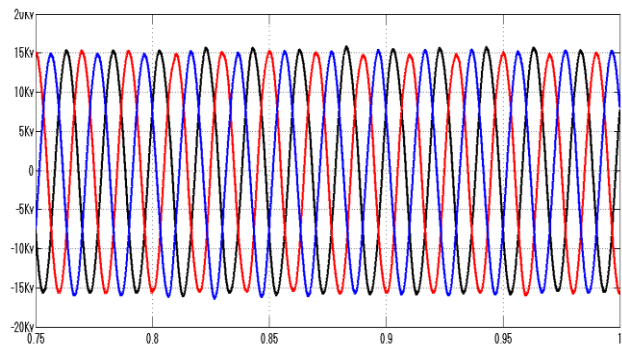

Fig.35: The load voltage at the second feeder (with DVR)

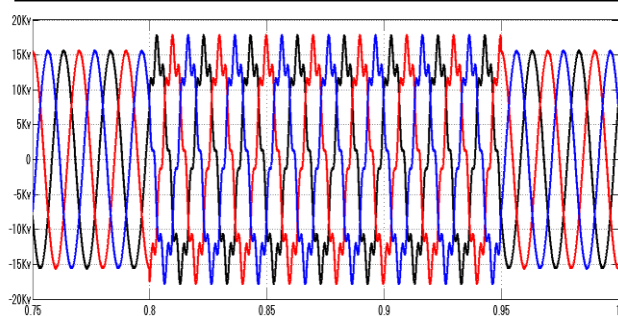

Fig.39: The load voltage at the first feeder (without DVR)

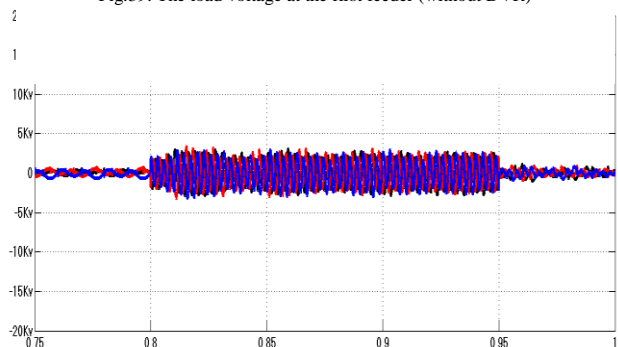

Fig.40: The injection voltage by the DVR

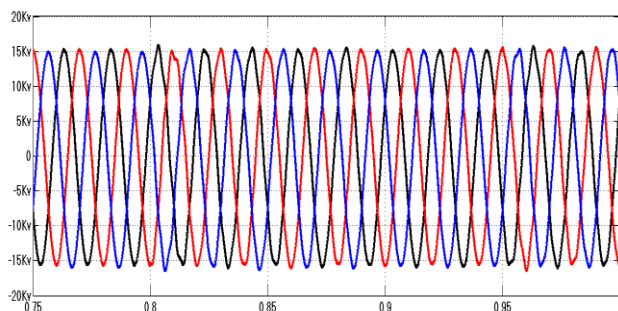

Fig.41: The load voltage at the second feeder (with DVR)

Case-7: Source voltage with 11th and 13th harmonics

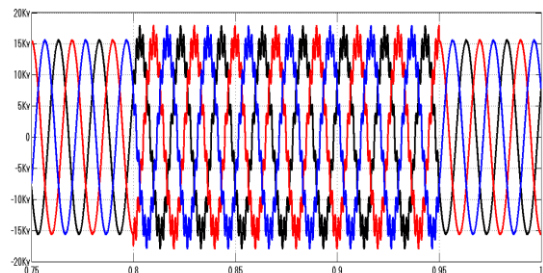

Fig.42: The load voltage at the first feeder (without DVR)

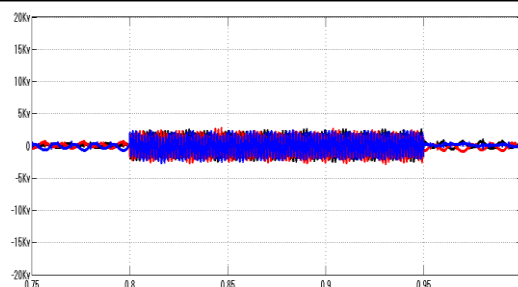

Fig.43: The injection voltage by the DVR

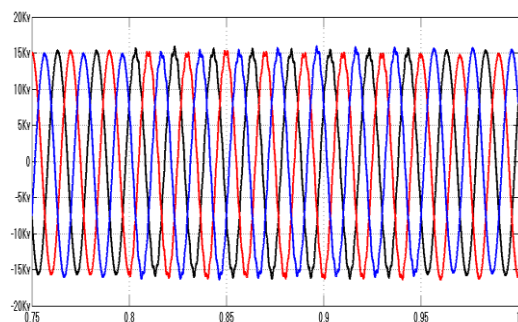

Fig.44: The load voltage at the second feeder (with DVR)

Table.5: The Change of DVR values

Power quality problems	Load voltage without DVR	Load voltage with DVR based on Fuzzy Logic controller
Sag	2.586	2.7
Swell	1.27	2.85
Voltage interruption	10.723	2.733
Source voltage with 2 nd and 3 rd harmonics	10.25	2.666
Source voltage with 3 rd and 4 th harmonics	10.25	2.74
Source voltage with 5 th and 7 th harmonics	10.25	2.19
Source voltage with 11 th and 13 th harmonics	10.25	2.996

XV. REFERENCES

- [1] Pandu Sathish Babu Nagappan Kamaraj, C 2017 'Power Quality Enhancement Using Dynamic Voltage Restorer', Lambert academic publishing, chapter.1, pp.2
- [2] Pandu Sathish Babu Nagappan Kamaraj, C 2017 'Power Quality Enhancement Using Dynamic Voltage Restorer', Lambert academic publishing, chapter.1, pp.12
- [3] Khalghani, MR, Shamsi-Nejad, MA, Farshad, M & Khooban, MH 2014, 'Modifying power quality's indices of load by presenting an adaptive method based on hebb learning algorithm for controlling DVR', *Automatika*, pp.153-161
- [4] Ferdi, B, Benachaiba, C, Dib, S & Dehini, R 2010, 'Adaptive PI control of dynamic voltage restorer using fuzzy logic', *Journal of Electrical Engineering: Theory and Application* vol. 1, no. 3, pp. 165-173.
- [5] Choi, S, Li, J & Vilathgamuwa, M 2005, 'A generalized voltage compensation strategy for mitigating the impacts of voltage sags/swells', *IEEE Power Engineering Society Winter Meeting*, vol. 4, pp. 2967-2972.
- [6] K. Ramakrishna & G. Koti , HO 2011, 'Performance investigation of neural network based unified power-quality conditioner' , *IEEE Transaction on power delivery* , vol. 26, no. 1, pp. 431-437.
- [7] Kinhal, VG, Agarwal, P & Gupta, HO 2011, 'Performance investigation of neural network based unified power-quality conditioner'. *IEEE Transactions on power delivery*, vol. 26, no. 1, pp. 431-437.
- [8] Dip, S, Ferdi, B & Benachaiba, C 2011, 'Adaptive Neuro Fuzzy Inference System based DVR Controller Design', *Leonardo Electronic Journal of Partices and Technologieas*, no. 18, pp.49-64.
- [9] Aali, S & Nazarpour, D 2011, 'Voltage quality improvement with neural network-based interline dynamic voltage restorer' , *Journal of Electrical Engineering & Technology*, vol. 6,no.6,pp.769-775
- [10] Singh, M & Chandra, A 2013, 'Real time implementation of ANFIS control for renewable interfacing inverter in 3P4W distribution network', *IEEE Transactions on Industrial Electronics*, vol. 60, no. 1, pp. 121-128.
- [11] Amutha, N & Kumar, BK 2013, 'Improvement fault ride-through capability of wind generation system using DVR' , *Electrical Power and Energy System* , vol. 46, no. 1 , pp. 326-333 .
- [12] Pandu Sathish Babu Nagappan Kamaraj, C 2017, 'Power Quality Enhancement Using Dynamic Voltage Restorer' LAP LAMBERT Academic Publishing, pp. 73-74
- [13] Yu, H, Bogdan, M & Wilamowski, BM 2011, *Levenberg-Marquardt Training*, [Online Available]:http://www.eng.auburn.edu/~wilambm/pap/2011/K10149_C012.pdf
- [14] Hung T.Nguyen , Nadipuram R. Prasad Carol L. Walker , Elbert A. Walker. 'A First Course in FUZZY and NEURAL CONTROL', printed in the United States of America 1234567890 printed on acid -free paper; chapter.2; pp.88-90