

DOI: [http://dx.doi.org/10.21123/bsj.2021.18.2\(Suppl.\).1113](http://dx.doi.org/10.21123/bsj.2021.18.2(Suppl.).1113)

Noor's Curve, a New Geometric Form of Agnesi Witch, a Construction Method is Produced

Laith Hady M. Al-Ossmi

College of Engineering/ University of Thi-Qar, Thi-Qar, Iraq.

E-mail: laith-h@utq.edu.iq , hardmanquanny@gmail.com

ORCID: <https://orcid.org/0000-0003-4295-8965>

Received 21/3/2020, Accepted 28/10/2020, Published 20/6/2021



This work is licensed under a [Creative Commons Attribution 4.0 International License](https://creativecommons.org/licenses/by/4.0/).

Abstract:

In this paper, a new form of 2D-plane curves is produced and graphically studied. The name of my daughter "Noor" has been given to this curve; therefore, Noor term describes this curve whenever it is used in this paper. This curve is a form of these opened curves as it extends in the infinity along both sides from the origin point. The curve is designed by a circle/ ellipse which are drawing curvatures that tangent at the origin point, where its circumference is passed through the $(0,2a)$. By sharing two vertical lined points of both the circle diameter and the major axis of the ellipse, the parametric equation is derived. In this paper, a set of various cases of Noor curve are graphically studied by two curvature cases; a circle and an ellipse, and all figures and obtained rigour measurements are checked by AutoCAD program. With its simple, symmetric form, the future predictions are tuned for the Noor's curve to be usefully engaged in important practical applications.

Key words: Agnesi, Construction Method, Curves, Ellipse, Noor

Introduction:

A curved line is a locus of points that lie evenly, and can be classified. They can be written in parametric form, however, curves can be two dimensional (plane curves) or three dimensional (space curves). In the course of history, many individuals have the dubious honor of being remembered primarily for an eponym of which they would disapprove. In this connection, the witch of Agnesi is named for a person who discovers it. The curve was studied by Pierre de Fermat in his 1659 treatise on quadrature (1). Fermat had studied curves of the general form $(a^2-x^2)y = a^3$, (2) and Guido Grandi had also included the curve in a 1703 paper (3- 4). Grandi had given the curve the name *versiera* in the first place (5), saying he adapted it from the Latin word *versoria* (6-7).

The Witch of Agnesi is tangent to its defining circle at one of the two defining points and asymptotic to the tangent line to the circle at the other point (8). It has a unique vertex (a point of extreme curvature) at the point of tangency with its defining circle, which is also its osculating circle at that point (9). To construct this curve, start with any two points O and M , and draw a circle with OM as diameter. For any other point A on the circle, let N be the point of intersection of the secant line OA and the tangent

line at M . Let P be the point of intersection of a line perpendicular to OM through A , and a line parallel to OM through N . Then P lies on the witch of Agnesi (10). The Agnesi can be illustrated as it is shown in Fig.1.

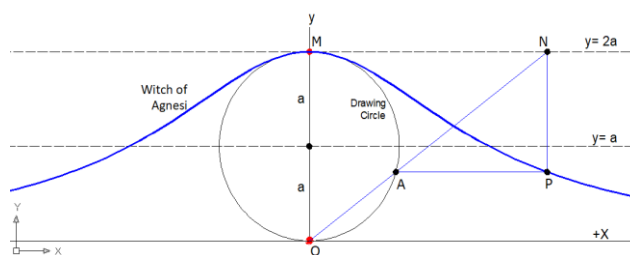

Figure 1. The witch curve of Agnesi (bold blue) with labeled points

To construct witch of Agnesi, start with any two points O and M , and draw a circle with OM as diameter. For any other point A on the circle, let N be the point of intersection of the secant line OA and the tangent line at M . Let P be the point of intersection of a line perpendicular to OM through A , and a line parallel to OM through N . Then P lies on the Witch of Agnesi. The witch consists of all the points P that can be constructed in this way from the same choice of O and M . It includes, as a limiting case, the

point M itself (6). The witch of Agnesi can also be converted a new form of curves by changing the tangency structure whose parameter u is guided by a shifted circle moving along the positive and negative sides of x -axis between OM and OA , measured clockwise, this curve is Noor.

In this paper, the *Noor* is a name used for a new form of curves that is produced from the locus of points led by a line from a point which is intersecting the circumference of two tangent curvatures. Therefore, Noor curve is sketchily produced to be constructed by two cases of curvatures; a circle and an ellipse. All obtained figures in this paper have been drawn and measured by AutoCAD program, (Version 2007).

In general, the Noor curve in this paper is studied within two cases by a fixed drawing circle which tangents a shifted circle at the origin point (A), in addition to a special case which is designed to produce this curve by using an ellipse as a shifted

curvature, thus in this paper, a constructing method for *Noor* curve is designed as a graphical way to deal with these two cases.

A Constructing Method for Noor's Curve

A new form of opened curves is produced and called Noor's curve. This curve is produced by a fixed point (A) located at the origin point, which is the tangent point of the circle (drawing circle) on the x -axis. By drawing a set of circles which are parallel and shifted along both sides of the x -axis, the segment line from point (A) extends to intersect the drawing circle on point (B), extending to pass these shifted circles through center points (C), and extends to intersect the circumference on points (P). From (P), a vertical line that to intersect the horizontal which is already drawn from point (B), the intersection point is (D) which is a point of the Noor curve, Fig.2.

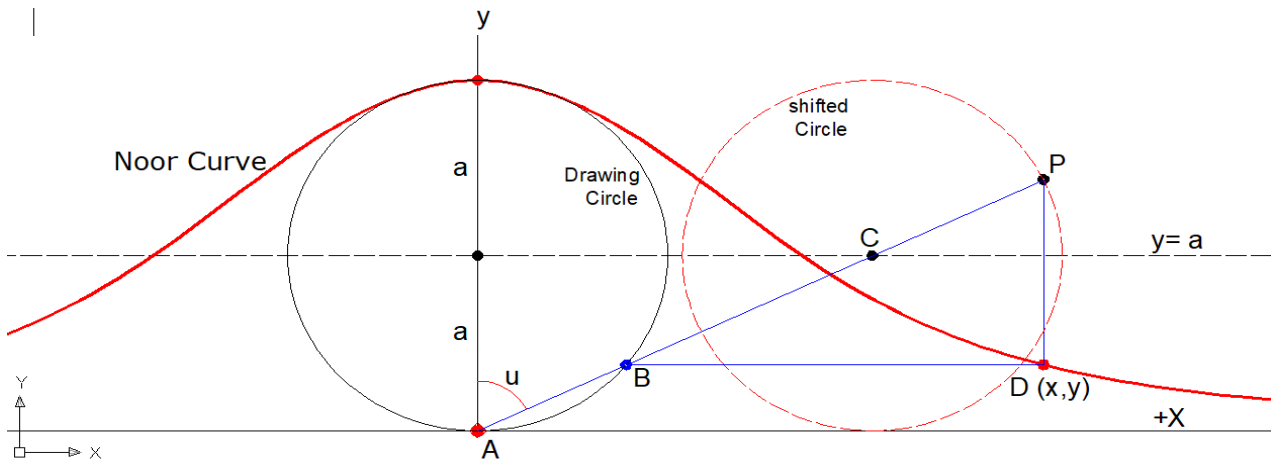

Figure 2.plot a construction method to draw Noor curve which is issued according to first case, where (C) located at $(y=a)$ is the center point of the shifted circles.

Figure 2 indicates that the curve is drawn by a fixed circle (the drawing circle), where point (A) is the tangent point on the y & x -axis. The main point in this curve is that the line segment (AB) extends to intersect the shifted circumferences on points (P) passing through the center points (C). In general, the shifted circles must be moved along the x -axis, thus their center point (C) located at locus of points (x,a) , however, changing the distance between center points of each two circles does not matter to the curve shape. Therefore, the curve point

and the (B) point are sharing the same value of (x) , and then the y -value is the main parameter in this case.

Also, Fig. 2 shows that all points (B) are located on the drawing circle circumference, while points (P) are these located on the circumferences of shifted circles. By repeating the previous procedures on a set of shifted circles, points of (D) are determined and the curve is gradually shaped. The Noor's curve at both directions of x -axis is opened and extends in infinity, Fig. 3.

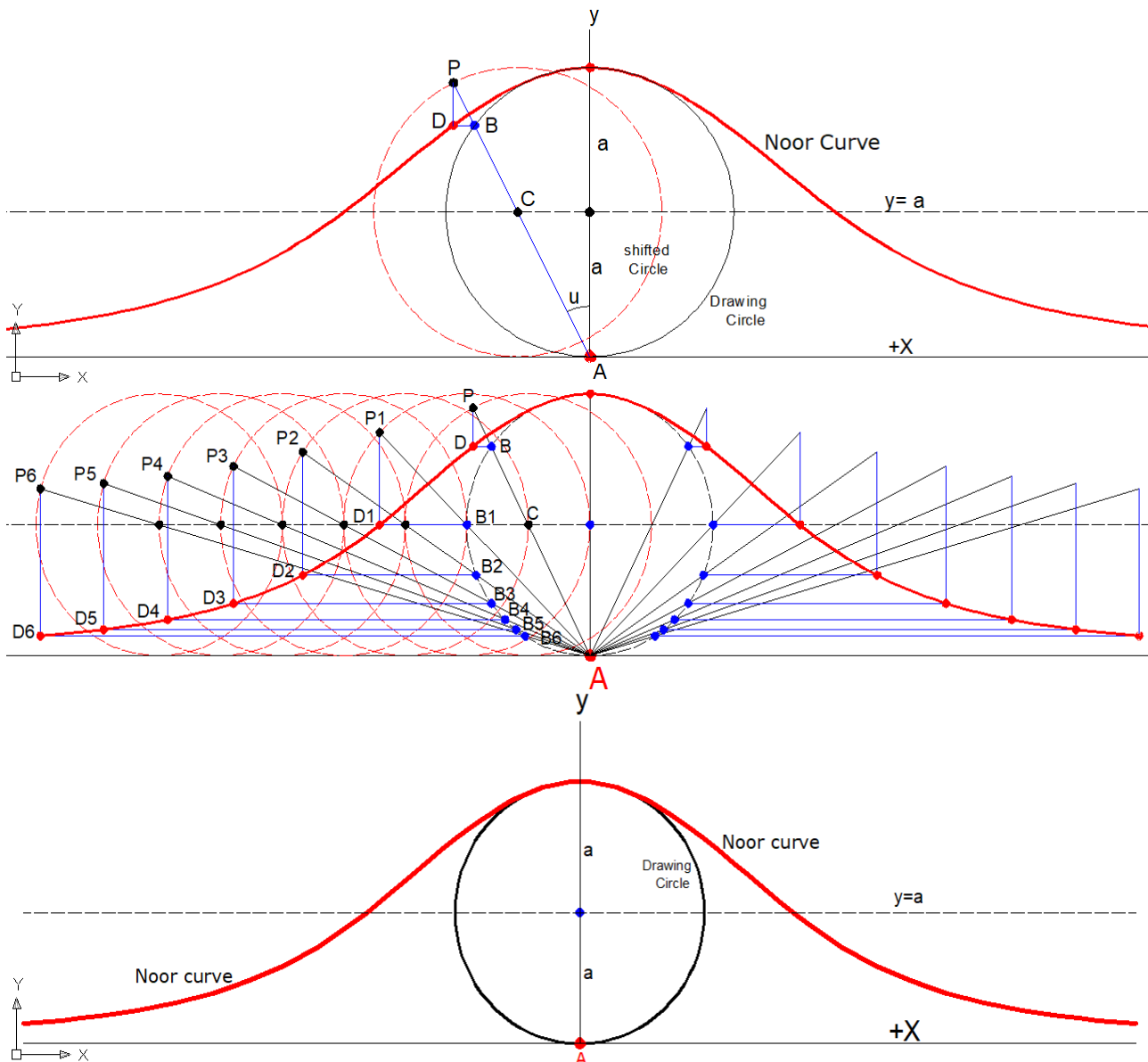

Figure 3. Plotting a construction method to draw Noor curve, note that the curve is extended in infinity at both directions of x-axis.

It is noticeable from Fig. 3, that there is only one circle (the drawing circle) which has the radius length equals to line segment ($AB=2a$), since all shifted circles along the curve points will have different segment lengths (PA). Also, this segment (AP) is intersecting the shifted circle at its circumference (point; P), as these vertical and horizontal perpendiculars are drawn from this point, this is the key difference in which the Noor's curve is being a different than the Witch curve. This difference is an advantage here that it helps to draw Noor curve in varying forms as the shifting circles can differ by increasing or decreasing its radius values, and the curvature can be a circle or an ellipse. And this is presented in a separated subsection in this paper.

A special Case of Noor's Curve:

The Noor's curve is constructed in this case by two tangent circles at the point (A), where the drawing circle has a smaller radius than that the shifted circle. The main construction procedures of this case can be listed as follows, see Fig. 4:

- Let a drawing circle with a radius of (a), which tangents the x-axis at the origin point, and from the origin point, locate a point (A).
- Let a circle (shifted circle) with a different radius (let it be; $2a$), and a center point (T), this circle tangents the drawing circle at point (A) (Fig.5).
- Along the positive or negative side of x-axis, construct a set of shifted circles which have the same radius ($2a$) and all tangent the x-axis.
- By drawing the first shifted circle, let a line segment from point (A) to the center point of the shifted circle (T), note that the line (AT) is passing

through the circumference of the drawing circle at point (B).

- Extend the line segment (AT) to intersect the circumference of each shifted circle at point (P).
- From points (P) and (B) draw two perpendiculars, the horizontal and the vertical, which intersected at the point (D), where point (D) is the point of the Noor's curve.
- Repeat the previous procedures to determine as many as positions of point (D).

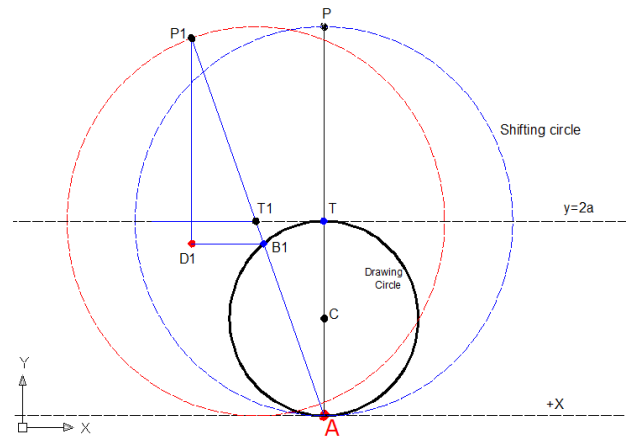

Figure 4. construction method to draw Noor's curve, (in this case), the line segments from point (A) passes through the center points of the shifted circles (points T_1), where the drawing circle has a smaller radius than that the shifted circle.

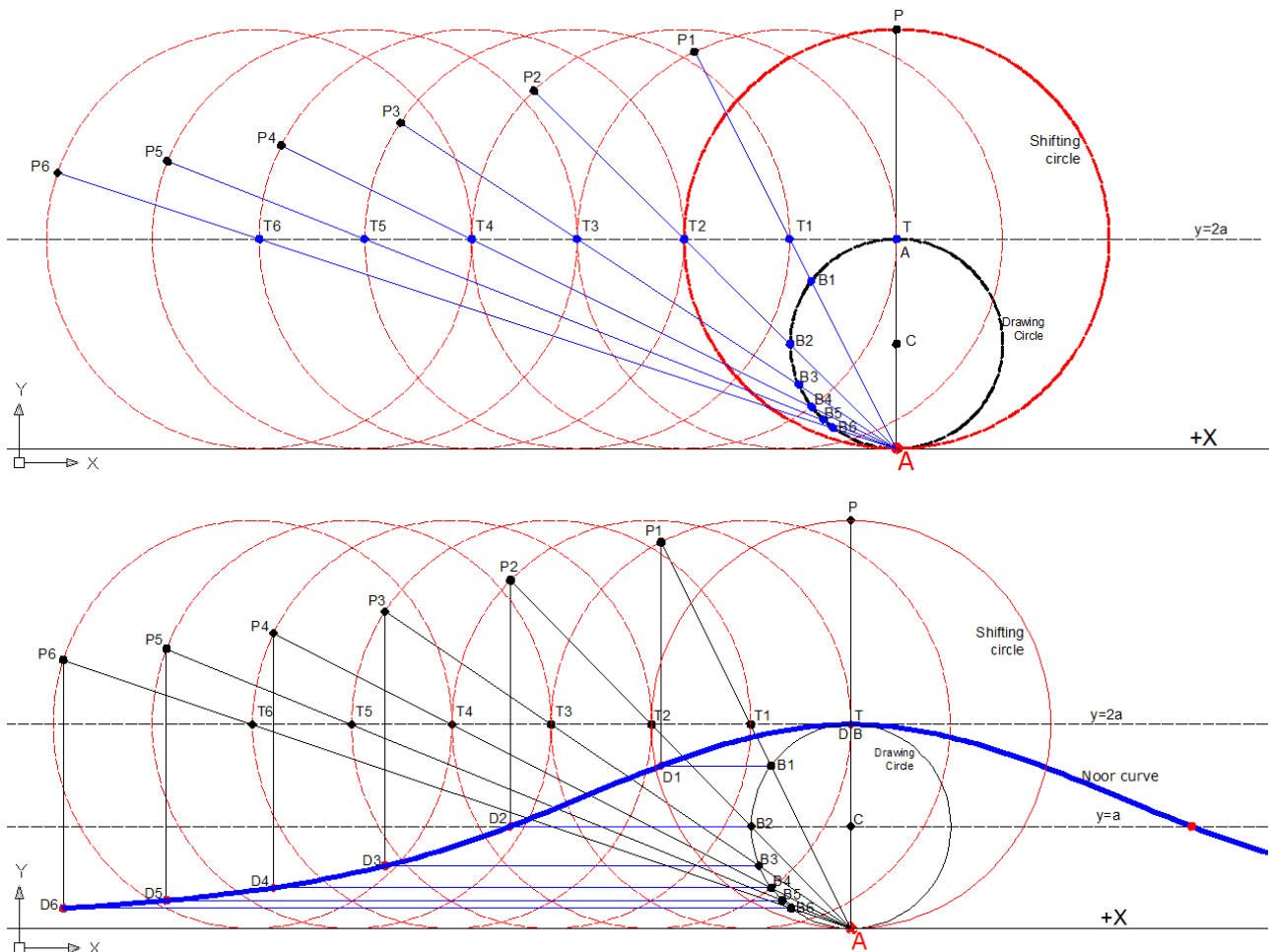

Figure 5. construction the Noor curve by this method, when radius of the shifted circle is $(2a)$.

In this case, let the radius of the shifted circle is $(1.50a)$, the Noor's curve is produced in the previous steps of this method as it is illustrated in Fig. 6.

Further properties of the curve may be of interest. At the first sight, the highest point is still that the point of tangency of the curve and the drawing circle at $(0,2a)$, and the y-intercept equals to $(2a)$.

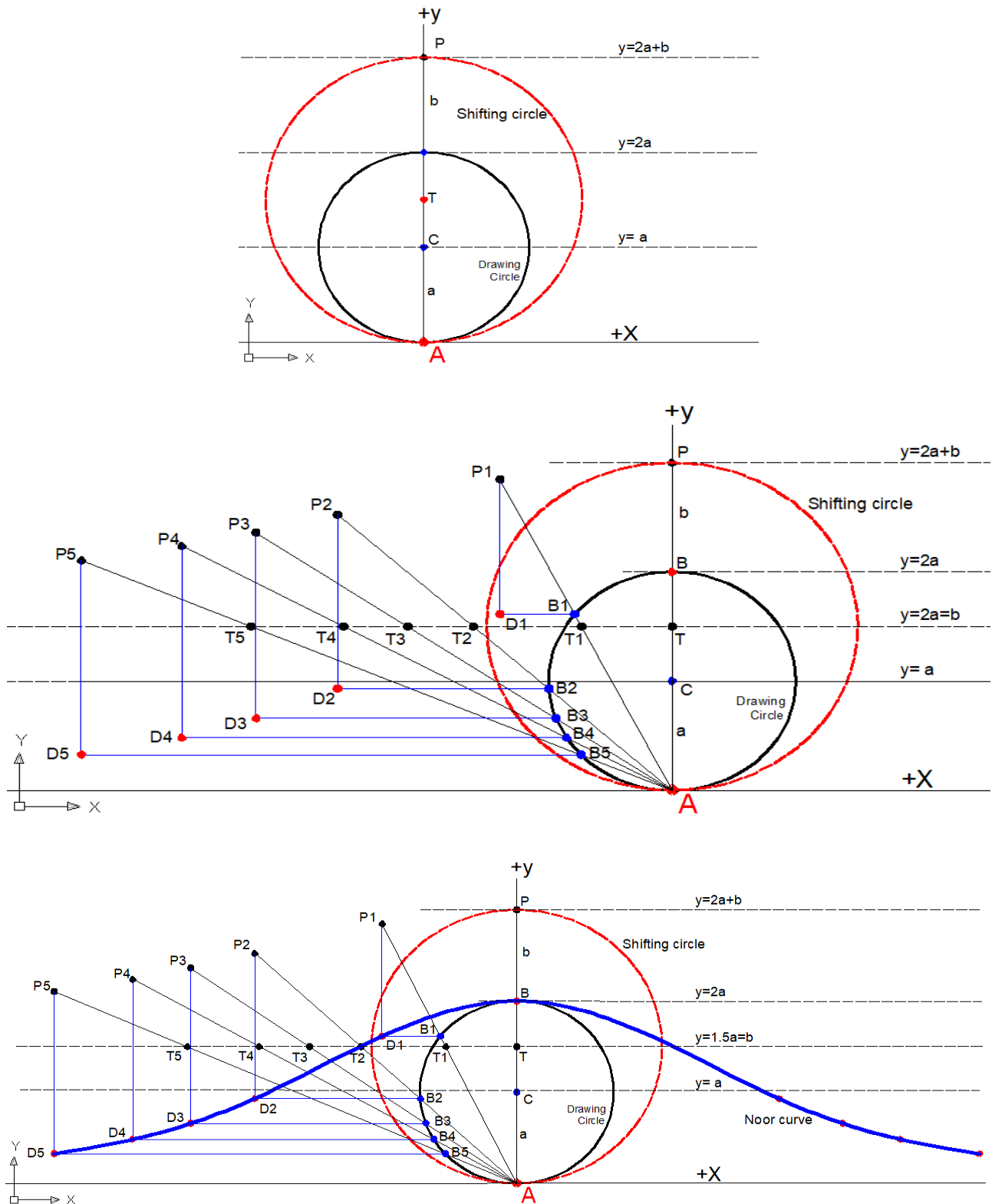

Figure 6. construction the Noor's curve by this method, when radius of the shifted circle is $(1.50a)$.

By drawing these 4 cases of Noor's curve, Fig. 6 shows that the radius length of the shifting circle is tested by; $(a, 1.25a, 1.5a$ and $1.75a)$. According to the fact that the Noor curve is extending in infinity along the x-axis, a slice of these 4 cases of the curve was taken within a random range of x-axis

which is equal to $(8a)$. Figure 7 shows that the curve length is reversed proportional whenever it's shifting circle' radius is increased. And in every case, the curve is intersecting the y-axis on one point which is the top point of the vertical diameter of the drawing circle, while its length is leading in

the infinity along the negative and positive sides of x-axis since it never intersects the x-axis. In general, by fixing the radius of the drawing circle, the radius

of the shifted circle is a parameter to determine the bulge of the Noor's curve.

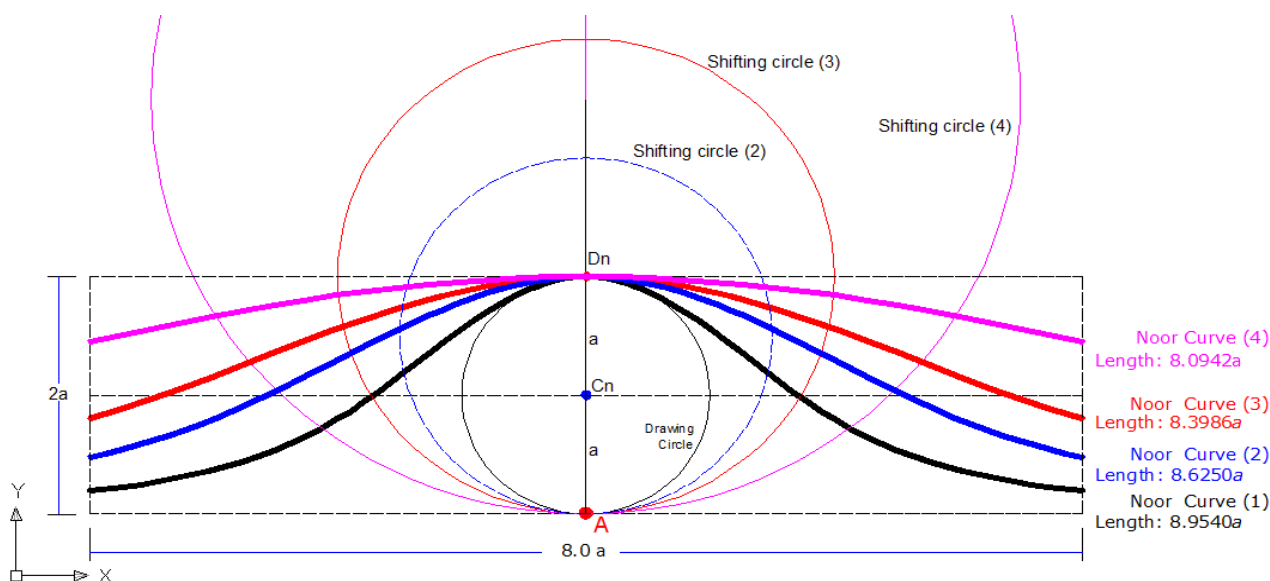

Figure 7. construction the Noor's curve in 4 nominated cases, when the radius length of the shifting circle is ;(a , $1.25a$, $1.5a$ and $1.75a$)

Figure 7 indicates that whenever the radius length of the shifting circle increased, the inflation of the curve gradually increased, and the intersection point of the curve at level of ($y=a$) is proportionally increased too, as they are listed in Table 1.

Table 1. the Noor's curve in 4 nominated cases, when the radius length of the shifting circle is ;(a , $1.25a$, $1.5a$ and $1.75a$).

Radius length of the shifting circles	Curve Length (within this slice of $\mp x$ -axis; ($-4.0a$, $+4.0a$))
a	$8.9540a$
$1.25a$	$8.6250a$
$1.5a$	$8.3986a$
$1.75a$	$8.0942a$

When the Shifted Curvature is an Ellipse:

Building on this method, the Noor's curve is produced by using an ellipse instead of a shifted circle. In this case, the drawing circle still fixed and tangent the ellipse on the origin point (A), where the ellipse minor axis length equals to ($2a$) and lies on y-axis from the point (A). For the research size aspects, the Noor's curve is studied in this paper by letting the selected ellipse to be tangent the drawing circle at two points, (A) and (B) respectively, which are the points of both vertical diameter of the drawing circle and the minor axis of the ellipse. Also, line segments from the point (A) are drawn to pass through the center points of the shifted ellipses and then extend to intersect the ellipse circumferences at point (P), to obtain the intersection points (D) of both the vertical and horizontal lines, which are points of the Noor curve, Fig. 8.

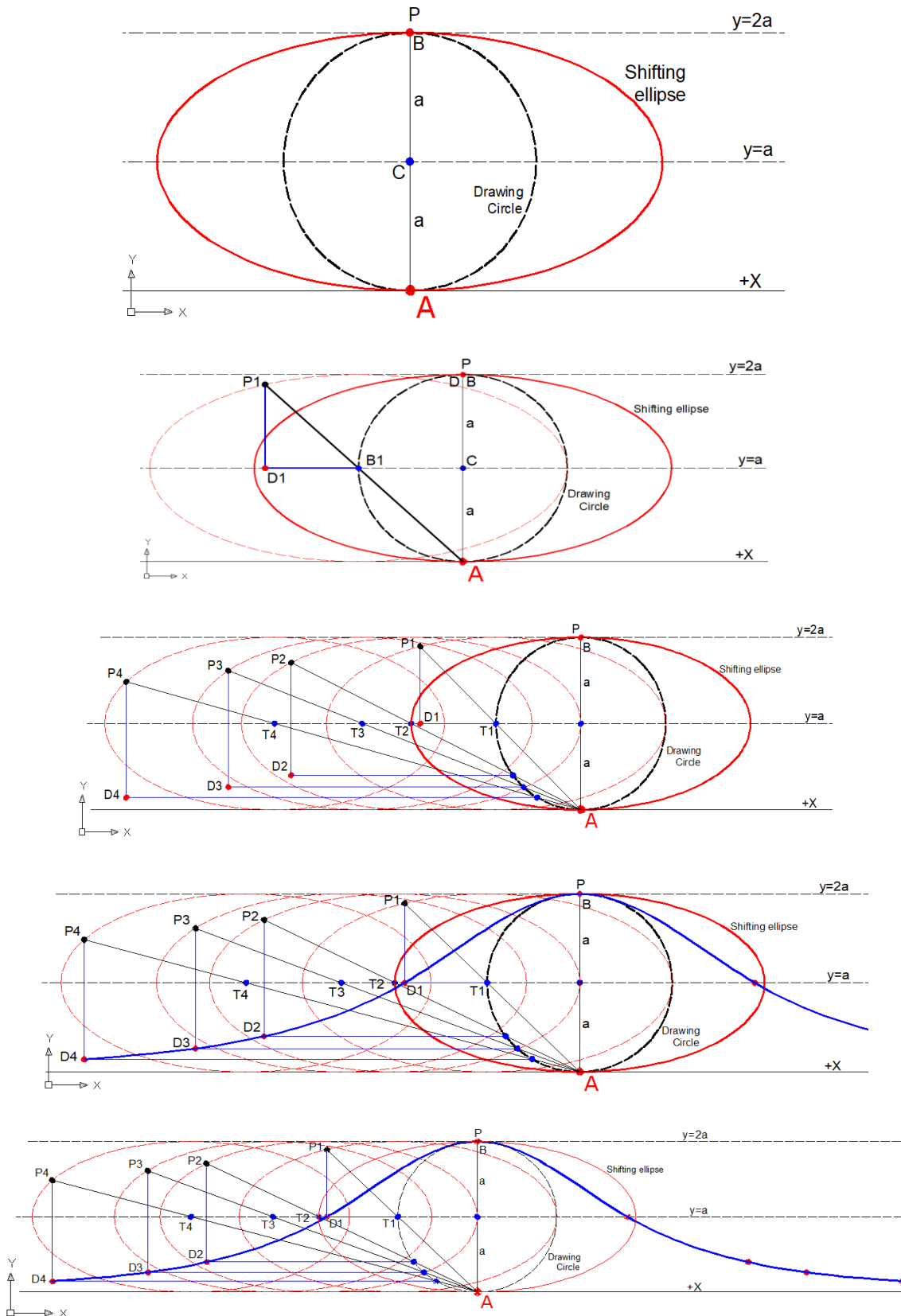

Figure 8. construction method to Noor's curve by a shifted ellipse, as the minor axis lies on the y-axis and equals to $(2a)$, and the center point of the shifted ellipse is located on the point $(B1)$.

By fixing the length of the minor axis to be $(2a)$, any change in the length of the major axis will slightly lead to enlarge and stretch the curve. For

example, the Noor's curve in Fig. 10, (plotted bold red No.1), which is drawn by an ellipse whose major axis is $(1.964a)$ intersects the horizontal line

at points; $(a,+1.8886a)$ and $(a,-1.8886a)$. While the curve, (plotted bold blue No.2), which is in this case drawn by an ellipse whose major axis is $(3.2622a)$ intersects the horizontal line at points; $(a,+1.942a)$ and $(a,-1.942a)$. By using the AutoCAD program, the obtained measurements from the curve slice passes through points $(a,+1.8886a)$, $(a,-1.8886a)$ and $(0,2a)$ indicates that the length of this part of the curve, (bold red No.1), is $(4.4186a)$. While the measurements obtained from the curve slice, (bold blue No.2), which passes through points $(a,+1.942a)$, $(a,-1.942a)$ and $(0,2a)$ indicates that the length of this part of the curve is $(4.3282a)$. Although the clear difference in the length of the major axis of the ellipses, it can be indicated from this slice that these two forms of this curve have a slightly difference related to the length which is in this case less than $(0.0904a)$, Fig. 9.

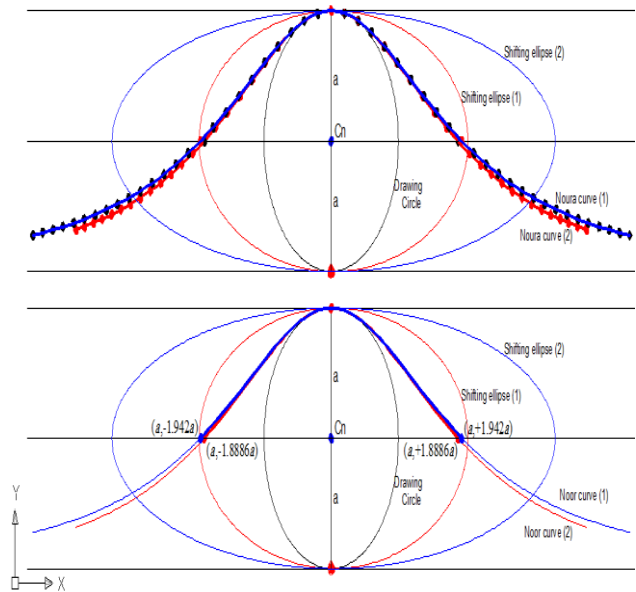
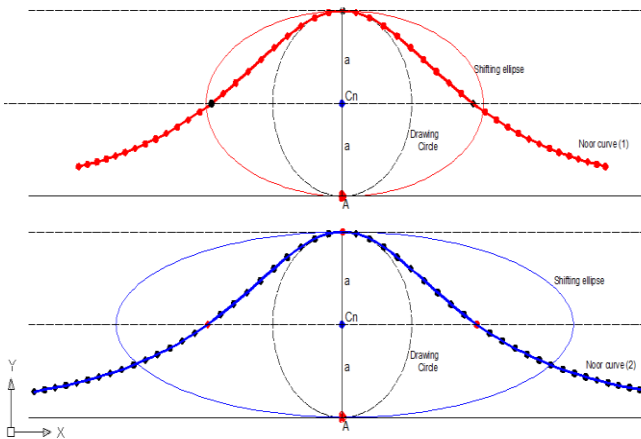

Figure 9. By fixing the length of the minor axis to be $(2a)$, any change in the length of the major axis will slightly lead to enlarge and stretch the Noor's curve.



Parametric Equation of the Noor's Curve, (when its curvature is a circle):

In this paper, it will deal with the first case of the curve where shifted circle shares the same length of the drawing circle' radius (a) , as they work as a set of curvatures along the x-axis. Suppose that point (A) is at the origin and point (E) placed on the positive y-axis, and that the circle with a secant (AB) has radius (a) . Then Noor's curve is constructed from (D) and (E) has the Cartesian equation as follows, Fig. 10:

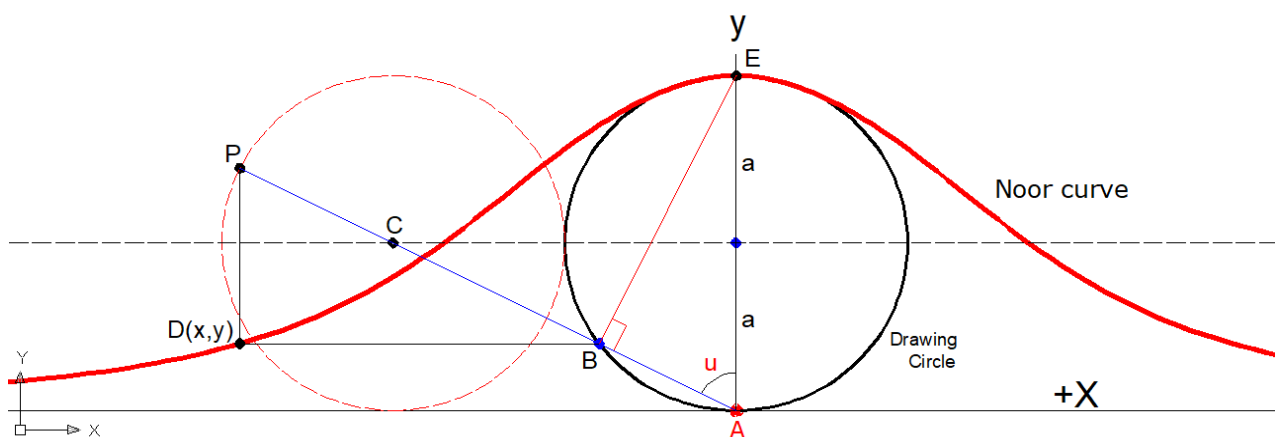

Figure 10. main key features of Noor's curve, where : $a = 0.5$

From the right angled triangle (ABE) whose a right angle is on the intersection point (B), and $(EA=2a)$, from this fact:
the secant line $(AB) = 2a \cos u$
Then, the Noor's curve Cartesian equations will be:

$$y = 2a \cos u \cdot \cos u,$$

$$y = 2a \cdot \cos^2 u, \dots \dots \dots (1)$$

Now, Fig. 10 shows also that :

$$(CA) = \frac{a}{\cos u},$$

The line segment

hence the horizontal distance from the two centers = $\left(\frac{a}{\cos u}\right) \sin u = a \tan u$,
since line segment (PC) = a , then ; $x = (a \sin u + a \tan u)$,
 $x = a(\sin u + \tan u)$,.....(2)

From equation (1), it is noticeable that when the witch of Agnesi and Noor curves are produced by the same radius value of drawing circle, (a), their points share the same value of (y), whereas they differ by the value of (x). In the Agnesi, it can be seen that the equation of ($x = 2a \tan u$) gives a value of (x), which is precisely greater by only ($0.00844029928a$) than that of Noor's equation (No.2). Therefore, the value of drawing circle's radius (a) and angle (u) are comparative parameters for both kinds of curves, Agnesi and Noor. Also, the volume generated by revolving any of curves, the Agnesi or Noor, about the y -axis is meaningless, Fig. 11 and Table 2.

Table 2. the following comparative properties of Agnesi and Noor's curves can be noted from a study of their equations:

Noor's curve	Agnesi's curve
• $x = a(\sin u + \tan u)$	• $x = 2a \tan u$
• There are no x -intercepts	• There are no x -intercepts
• The y -intercept is equal to ($2a$)	• The y -intercept is equal to ($2a$)
• There is symmetry about the y -axis	• There is symmetry about the y -axis
• $y = 2a \cos^2 u$, which cannot be negative	• $y = 2a \cos^2 u$, which cannot be negative
• There is only one asymptote, where $x = \pm\infty$	• There is one asymptote, $y = 0$
• There is a maximum point at ($0, 2a$).	• There is a maximum point at ($0, 2a$).

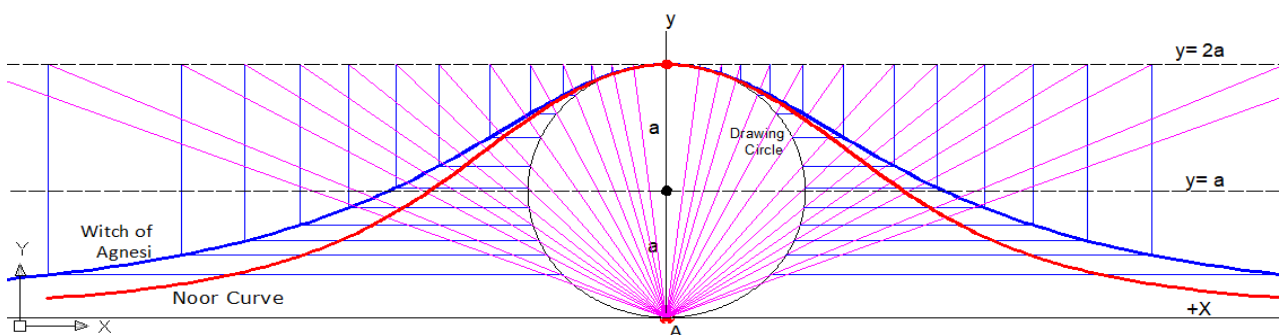

Figure 11. comparative properties of Agnesi and Noor curves, drawn by the same circle.

Mathematically, the Noor's curve is also a cubic plane curve defined from two diametrically opposite points of a circle or an ellipse. The Noor is tangent to its draining circle at one of the two defining points, and asymptotic to the line segment intersects to the shifted circle at the other point. It has a unique vertex (a point of extreme curvature) at the point of top with its defining circle, which is also its osculating circle at that point. It also has two finite inflection points and one infinite inflection point. The main properties of this curve can be derived from integral calculus, where the length of

the Noor's curve between them is determined by ($4.0266a$), Fig. 12. Also, the surface generated by revolution of the Noor's curve around its y -axis is the *Nooroid*. Therefore, volume of the solid of revolution is generated by rotating Noor's curve around its asymptote axis. The area between the curve and its asymptotic line is (2.49185) times the area of the fixed circle with radius (a), and the volume of revolution of the curve around the same line is approximately twice the volume of the torus formed by revolving the defining circle.

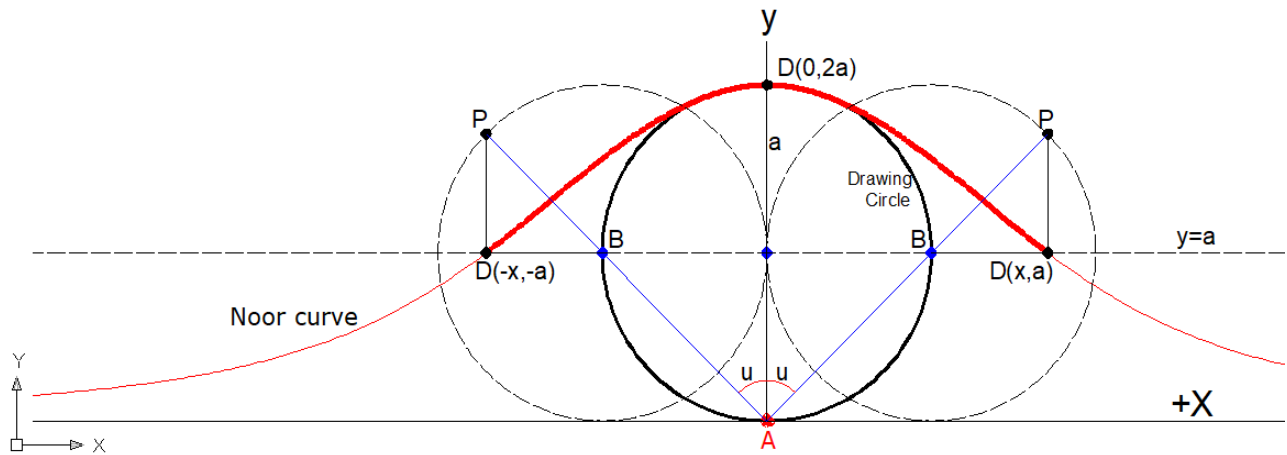

Figure 12. two finite inflection points and one infinite inflection point of Noor's curve, where : $a = 0.5$, and $u = 45^\circ$. And the shifted circles tangent the y-axis at $(0,+a)$.

The theorem of curve length:

Since $y = 0$ as $x = \pm\infty$, the x-axis is an asymptote in both directions of the Noor's curve. The length of a segment of Noor's curve can be geometrically determined by the following theorem;

- Let (D) is a couple points on both the positive and negative side of x-axis, through it the Noor's curve intersects the horizontal line which is the locus of all center points of the shifted circle, ($y=a$).
- Then let point (1) is the intersection point of the drawing circle on the horizontal line of ($y=a$). From the point (1) draw a circle with radius of the

distance between point (1) and (D), the intersection of this circle with Noor curve is point (2).

- From point (2), draw a second circle with radius of the distance from the point (2) to (D).
- The intersection of the second circle with the drawing circle is point (3), which determines the end of the circumference of drawing circle that equals to the length of Noor's curve drawn from points (D) at both sides along the origin point, see Fig. 13.

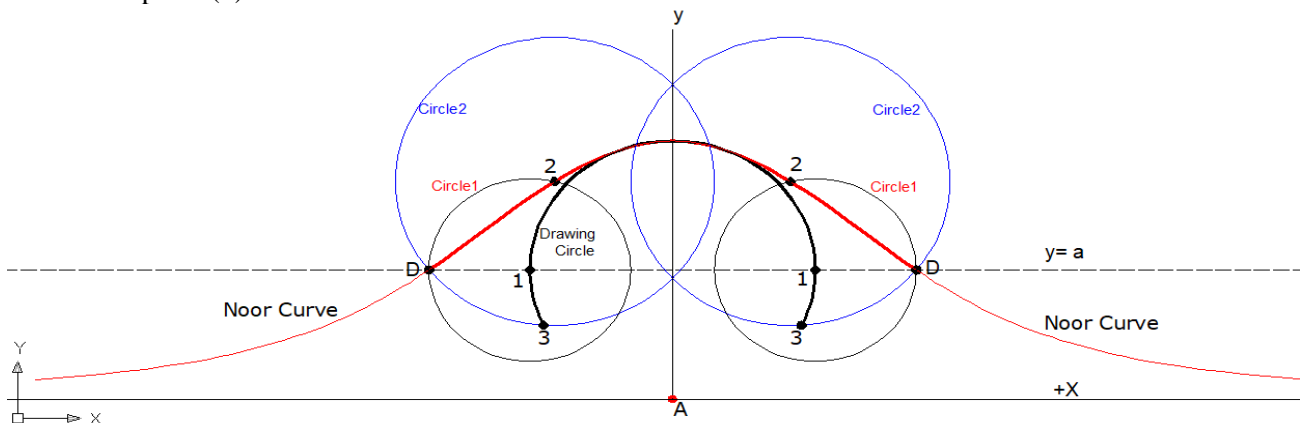

Figure 13. the geometric theorem in which the length of a slice of the Noor's curve passing through ($y = a$), can be precisely measured.

Figure 13 illustrates this theorem applied on a curve of Noor with a drawing circle's radius of (0.5), where the length value of the curve piece is measured ($4.0266a$) with a circumference piece of the drawing circle ($4.0272a$), which means a difference of only (0.0006).

Conclusions:

This paper deals with a new form of 2D - plane curve. The curve is given the name of *Noor* and its construction method is designed. The curve is intended by a fixed circle which is a drawing

circle that tangents at the origin point (A), where value (a) is the radius of this drawing circle laying on the y-axis as its circumference is passed through the $(0,2a)$. This article gives a new theorem method for key constructing features of this curve; the measurements demonstrated by this method were examined through 3 cases in which a circle and an ellipse used as shifted curvatures. The method has been proved with appropriate examples and a rigour help of AutoCAD program, which is having tremendous sides of accuracy, obtained from the curve's slice passes through points $(a,+1.8886a)$,

$(a,-1.8886a)$, $(a,+1.942a)$, $(a,-1.942a)$ and $(0,2a)$ along both sides of x-axis indicated that the length of any case of the curve is slightly differs between $(4.4186a)$ and $(4.3282a)$. Also, it is noticeable within this slice that the curve which is drawn by a shifted circle with a radius length (a) , has a length equals to $(8.954a)$, since the length of the curve is declined whenever its shifting curvature's radius is enlarged. Conceptually, by fixing the radius of the drawing circle, our construction method can be used to draw the Noor curve's key features for any values of the radius of shifted curvatures (circles or ellipses). Also, a new form of surface can be produced from this curve, which is the result of its revolved shape surface. The surface generated by the revolution of the Noor's curve around its axis is the *Nooroid*.

The Geometric and algebraic properties that both curves share are of importance to physicists. The Witch curve has an important application because it approximates the spectral energy distribution of x-ray lines and optical lines, as well as the power dissipated in sharply tuned resonant circuits. With its simple, symmetric form, the future predictions are expected for the Noor's curve to be usefully engaged in important practical applications.

Acknowledgements:

It gives immense pleasure to thank all those who extended their coordination, moral support, guidance and encouraged to reach the publication of the article. My special thanks to my family; Angham S.M., Noor, Nada, Fatima and Omneya, for their full support and co-ordination.

Author's declaration:

- Conflicts of Interest: None.
- I hereby confirm that all the Figures and Tables in the manuscript are mine. Besides, the Figures and images, which are not mine, have been given the permission for re-publication attached with the manuscript.

- Ethical Clearance: The project was approved by the local ethical committee in University of Thi-Qar.

References:

1. Fuchs D, Tabachnikov S. *Mathematical Omnibus: Thirty Lectures on Classic Mathematics*. Providence, RI: American Mathematical Soc. 2007; 5(3):142. doi:10.1090/mbk/046, ISBN 978-0-8218-4316-1, MR 2350979
2. Lipsman R, Rosenberg M. *Multivariable Calculus with MATLAB: With Applications to Geometry and Physics*. Springer, 2017;5(3): 42
3. Haftdorn D. *Versiera, die Hexenkurve, Kurven erkunden und verstehen (German)*, Springer.2017;10(2): 79-91. doi:10.1007/978-3-658-14749-5
4. Sushanta G, Kashi S . A parametric study on geometrically nonlinear behavior of curved beams with single and double link rods, and supported on moving boundary. *Int. J. Mech. Sci.*. 2019; 161(62): 105-106
5. Paula F. Calculations of faith: mathematics, philosophy, and sanctity in 18th-century Italy (new work on Maria Gaetana Agnesi). *Hist. Math.* 2011; 38(2): 248-291. <https://doi.org/10.1016/j.hm.2010.05.003>
6. Tania Y. Piecewise rational interpolation by witch of Agnesi. *J CAMathJ.* 2017; 36(4):1205–1216
7. Norando T, Magnaghi-Delfino P. Witch of Agnesi: The True Story. In *Faces of Geometry*. From Agnesi to Mirzakhani 2020 (pp. 155-163). Springer, Cham.
8. Gray S, Malakyan T. The Witch of Agnesi A Lasting Contribution from the First Surviving Mathematical Work Written by a Woman. *The College Mathematics Journal.* 2018;30(4):258-268
9. Roy S. Properties of the Witch of Agnesi - Application to Fitting the Shapes of Spectral Lines. *JOSA.* 1940;30(9):415-419
10. Paula F. Calculations of faith: mathematics, philosophy, and sanctity in 18th-century Italy (new work on Maria Gaetana Agnesi). *H.MJ* 2011;38(2):248-291

منحني نور، حالة هندسية جديدة من منحني اغنيس مع تطوير طريقة للرسم

ليث هادي منشد العصامي

قسم الهندسة المدنية، كلية الهندسة، جامعة ذي قار، ذي قار، العراق

الخلاصة:

في هذا البحث، نوع جديد من المنحنيات ضمن المستوي ثنائي الأبعاد قد تم تصميمه ودراسته. اسم نور (Noor) قد اطلق على هذا النوع من المنحنيات، و اي ذكر لهذا الاسم في البحث يعني الإشارة الى هذا النوع من المنحنيات. هذا المنحني هو نوع من المنحنيات المفتوحة التي تمتد الى الملائهائية و التي ترسم لتكون مفتوحة على كلا جانبي ابتداء من نقطة الاصل. المنحني صمم بهذا البحث بواسطة دائرة راسمة و التي تمس الاحداثيين عند نقطة الاصل حيث محيطها يمر بالنقطة $(0,2a)$ ، حيث قيمة (a) تمثل نصف قطر الدائرة الراسمه الذي يتموضع عند الاحداثي الصادي. من خلال اعتماد نقطتين من محاور متعامدة على محيط الدائرة الراسمة او من خلال المحور الكبير للقطع الناقص، يمكن اشتقاق معادلة نقاط المنحني. في هذا البحث، تم دراسة المنحني من خلال حالات متنوعه والتي تم رسمها على حالتين عندما المنحني الراسم هو دائرة او قطع ناقص، و كلا الحالتين المدروستين تم تدقيق نتائجها من خلال استعمال برنامج حاسوبي للرسم الهندسي الـ AutoCAD. في هذا البحث، السطح المتولد من دوران المنحني حول محوره قد تم تسميته بـ *Nooroid*.

الكلمات المفتاحية: اغنيس، طريقة تصميم المنحني، منحنيات، قطع ناقص، نور