

Batch and Flow-Injection Spectrophotometric Determination of Procaine HCl in Pharmaceutical Preparations Via Using Diazotization and Coupling Reaction

*Mouyed Q. Al-Abachi**

*Wasan A. Al-Uzri **

*Hind S. Al-Ward**

Received 15, September, 2011

Accepted 8, January, 2012

Abstract:

Simple and sensitive batch and Flow-injection spectrophotometric methods for the determination of Procaine HCl in pure form and in injections were proposed. These methods were based on a diazotization reaction of procaine HCl with sodium nitrite and hydrochloric acid to form diazonium salt, which is coupled with chromotropic acid in alkaline medium to form an intense pink water-soluble dye that is stable and has a maximum absorption at 508 nm. A graphs of absorbance versus concentration show that Beer's law is obeyed over the concentration range of 1-40 and 5-400 $\mu\text{g}\cdot\text{ml}^{-1}$ of Procaine HCl, with detection limits of 0.874 and 3.75 $\mu\text{g}\cdot\text{ml}^{-1}$ of Procaine HCl for batch and FIA methods respectively. The FIA average sample throughput was 70 h^{-1} . All different chemical and physical experimental parameters that affecting on the development and stability of the colored product were carefully studied and the proposed methods were applied satisfactorily for the determination of Procaine HCl in an injections samples using the standard addition method.

Key words: Procaine HCl, Spectrophotometric determination, Chromotropic acid, Diazotization and coupling, Flow injection.

Introduction:

Procaine is a local anesthetic can be used either alone or with penicillin as an antibacterial drug its chemical name is 2-diethyl aminoethyl-4-aminobenzoate hydrochloride and its formula $\text{C}_{13}\text{H}_{20}\text{N}_2\text{O}_2$, with molecular weight of 272.8 the structure of procaine HCl is [1]:

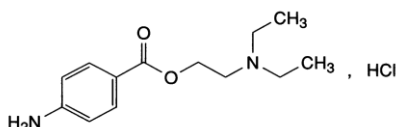

Procaine was first synthesized in 1905, it quickly replaced cocaine because it is easier to synthesize and sterilize, shorter duration of action, non addictive and it has four to six times

less toxic than cocaine, procaine, like other local anesthetics such as tetracaine acts as a nerve block, halting the generation and conduction of nerve impulses signal pain, it is also used in obstetrics and some times for relief pain in the lower back and tooth extraction [2]. Several methods have been reported for the determination of procaine HCl include High performance liquid chromatography [3,4], differential-plus voltammetry and electrochemical analysis [5-8], electrophoresis [9,10], atomic absorption [11], ion association titration [12], gas chromatography [13], fluorimetry [14-16], sequential injection analysis [17,18], flow

*Department of chemistry-College of Science-University of Baghdad-Baghdad-Iraq

injection analysis [19,20], chemiluminescence [21], colorimetry and spectrophotometric methods [22-28]. The present study describes the development of batch and FIA methods based on diazotization and coupling reaction between diazotized Procaine HCl and chromatropic acid reagent in alkaline medium. The pink product has been spectrophotometrically measured at 508 nm. The analytical procedure is simple, fast, accurate, and has been applied for the determination of Procaine HCl in pure and injections preparations using standard addition method. The reaction can be carried out in batch and FIA and the two approaches are compared.

Materials and Methods:

Apparatus

All spectral and absorbance measurements were carried out on a Shimadzu UV-Visible-260 digital double-beam recording spectrophotometer (Tokyo-Japan), and photomech 301-D⁺ spectrophotometer (Optima-Japan) using 1-cm quartz cells. A quartz flow cell with 50 μ l internal volume and 1 cm bath length was used for the absorbance measurements. A two channel manifold (Figure 4) was employed for the FIA spectrophotometric determination of Procaine HCl. A peristaltic pump (Ismatec, Labortechnik-Analytic, CH-8152, Glatbrugg-Zurich, Switzerland, six channels) was used to transport the reagents solutions. Injection valve (Rheodyne, Altex 210, Supelco-USA) was employed to provide appropriate injection volumes of standard solutions and samples. Flexible vinyl tubing of 0.5 mm internal diameter was used for the peristaltic pump. Reaction coil (RC) was of Teflon with internal diameter of 0.5 mm. In (Figure 4) the chromatropic acid (R1) stream was

combined with injected sample (Procaine HCl and sodium nitrite and hydrochloric acid) and they merged with NaOH (R2) stream at T-link then mixed in reaction coil (RC) with length of 100 cm, injection loop of (150 μ l), total flow rate of 2.4 ml/min, the absorbance was measured at 508 nm. and at temperature (10-15° C).

Reagents and materials

Analytical reagents grade chemicals and distilled water were used thoroughly.

a- For batch method

Procaine HCl stock solution (1000 μ g.ml⁻¹ = 3.66 x 10⁻³M): a 0.10000 gm amount of pure Procaine HCl (SDI) was dissolved in amount of distilled water then complete to 100 ml in a volumetric flask with the same solvent. Procaine HCl working solution (500 μ g.ml⁻¹ = 1.832 x 10⁻³M), was prepared by dilution of 50 ml of the stock solution to 100 ml volumetric flask with distilled water.

Sodium nitrite (3.66 x 10⁻³M): A 0.02525 gm amount of NaNO₂ (Merck) was dissolved in a 100 ml volumetric flask with distilled water. More dilute solution (1.832 x 10⁻³M) was prepared by simple dilution.

Chromatropic acid (0.1 % w/v) reagent solution: prepared by dissolving 0.1 gm of pure chromatropic acid (BDH) in amount of water and complete the volume to 100 ml volumetric flask with distilled water.

Hydrochloric acid (BDH) (1M), Sodium hydroxide (2M).

b- For flow-injection method

Diazotized Procaine HCl stock solution (500 μ g.ml⁻¹=1.832 x 10⁻³M): a 0.0500 gm amount of pure Procaine HCl (SDI) was dissolved in an amount

of distilled water then 0.01264 gm of sodium nitrite and 8 ml of (1M) Hydrochloric acid were added, shake well and complete to 100 ml in a volumetric flask with distilled water.

Chromatropic acid (0.07 % w/v) reagent solution: prepared by dissolving 0.0700 gm of pure chromatropic acid (BDH) in 100 ml volumetric flask with distilled water.

Sodium hydroxide (0.7M)

More dilute solutions were prepared fresh daily by suitable dilution of the stock solution with distilled water.

Procedure for Injections:

Two types of injection were analyzed by the developed methods, these include:-

1-Procaïne benzyl penicillin injection (300 mg Procaïne penicillin)-Ajanta House Charkop-India

2-Procaïne benzyl penicillin injection-(800 mg Procaïne Penicillin)- Troge Medical GMBH –Germany For these types of injection, an accurately weighed portion from mixed three vials powder, equivalent to about 0.0500 gm of Procaïne HCl, was transferred into a 100 ml volumetric flask and was dissolved and completed to the mark with distilled water to obtained $500 \mu\text{g.ml}^{-1}$. Aliquot samples were treated exactly the same as in the procedure cited for the batch method.

For FIA method, an accurately weighed portion from mixed three vials powder equivalent to about 0.0500 gm of Procaïne HCl, 0.01264 gm of sodium nitrite and 8 ml of (1M) Hydrochloric acid were added, shake well and complete to 100 ml in a volumetric flask with distilled water to obtained $500 \mu\text{g.ml}^{-1}$ ($1.832 \times 10^{-3}\text{M}$). More dilute solutions were prepared by simple dilution for the stock solution with distilled water.

Procedures:

General batch procedure

An increasing volumes (0.05-2 ml) of $500 \mu\text{g.ml}^{-1}$ ($1.832 \times 10^{-3}\text{M}$) Procaïne HCl was transfer into a series of 25 ml standard flask. (0.05-2 ml) of sodium nitrate ($1.832 \times 10^{-3}\text{M}$) and 2 ml of 1M Hydrochloric acid were added and shake well followed by the addition of 3 ml of (0.1%) chromatropic acid and 1 ml of sodium hydroxide (2 M). The contents of the flasks were diluted to the mark with distilled water, mixed well and left for 10 min at temperature ($10-15^{\circ}\text{C}$), the absorbance of the pink dye formed was measured at 508 nm against a reagent blank containing all materials except Procaïne HCl. A calibration graph was drawn and the regression equation was calculated, for the optimization of conditions and in all subsequent experiments, a 1 ml of ($500 \mu\text{g}$ in a final volume of 25 ml = $1.832 \times 10^{-3}\text{M}$) of Procaïne HCl was used.

General FIA procedure

A diazotized Procaïne HCl solution in the range of 5- 400 $\mu\text{g.ml}^{-1}$ were prepared from the working solution of $500 \mu\text{g.ml}^{-1}$ ($1.832 \times 10^{-3}\text{M}$) and stoichiometric amount of sodium nitrite. A 150 μl portion of Procaïne HCl was injected into the stream of the chromatropic acid (0.07% w/v) then the mixture combine with (0.7 M) NaOH at T-link with a total flow rate of 2.4 ml min^{-1} for the two channels, the resulting absorbance of the red product was measured at 508 nm and a calibration graph was constructed. Optimization of conditions were carried out on $500 \mu\text{g.ml}^{-1}$ of Procaïne HCl.

Results and Discussion:

Batch spectrophotometric determination

The factors that affecting on the sensitivity and stability of the colored

product resulting from the diazonium reaction between diazotized Procaine HCl and chromatropic acid in alkaline medium were carefully studied. A typical spectrum for the azo dye formed was measured versus reagent blank which has negligible absorbance at λ_{\max} 508 nm (Figure 1).

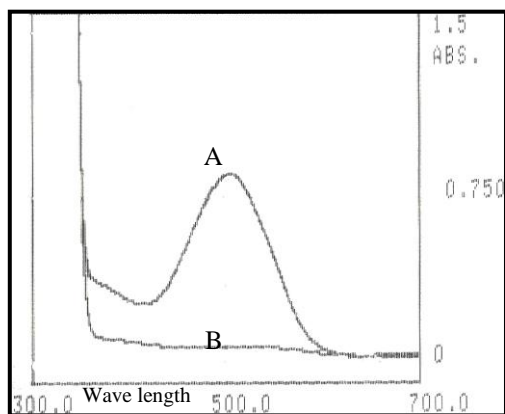

Fig. 1: Absorption spectra of the azo dye (20 ppm) against reagent blank (A) and blank against distilled water (B).

The experimental conditions for the determination of Procaine HCl were established. The diazonium reaction occurred in an acidic medium and hydrochloric acid of concentration 1M was selected, the effect of different volumes of 1 M of HCl were studied and 2 ml volume seems to be the optimum for an intense azo dye absorbance. A 1:1 mole ratio of Procaine HCl to sodium nitrite of (1.83×10^{-3} M) was used in order to prevent the effect of excess of sodium nitrite. The effect of coupling reagent (0.1% w/v) Chromatropic acid volume (0.3-5 ml) on the intensity of the absorbance, were studied and 3 ml was found to be optimum. The absorbance of the dye formed became more intense and stable in alkaline medium, therefore, the effect of different alkaline solutions on the colored product were studied sodium hydroxide, ammonium hydroxide, potassium hydroxide, sodium acetate

and sodium carbonate. Maximum sensitivity and stability were obtained only when the reaction was carried out in the presence of sodium hydroxide solution. The effect of different concentrations of NaOH (0.1-3 M) were studied, and 2 M seems to be optimum. The effect of (2M) NaOH volumes (0.1 to 2.5 ml) were also studied and 1 ml was found optimum. Experimental results revealed that the colour intensity reach a maximum after Procaine HCl solution had been reacted with chromatropic acid in alkaline medium for 20 min, therefore, a 20 min development time was suggested as the optimum reaction time and remain stable for 120 min. The order of addition of the reagents is an essential part of the experiment, it was found that the order of addition of the reagent cited under general procedure gave a maximum color intensity and the minimum absorbance of the blank and was used in all subsequent experiments. The effect of temperature on the colour intensity of the dye was studied. In practice, a higher absorbance was obtained when the reaction was developed at room temperature ($10-15^{\circ}$ C) and when the calibrated flasks were placed in an ice bath ($0-5^{\circ}$ C) or in water bath (60° C) a decreased in absorbance were observed. The stoichiometry of the reaction between Procaine HCl and chromatropic acid was investigated by using both continuous variation and molar ratio methods respectively. The result obtained (figure 2&3) show that a (1:1) azo dye was formed between diazotized procaine HCl and chromatropic acid

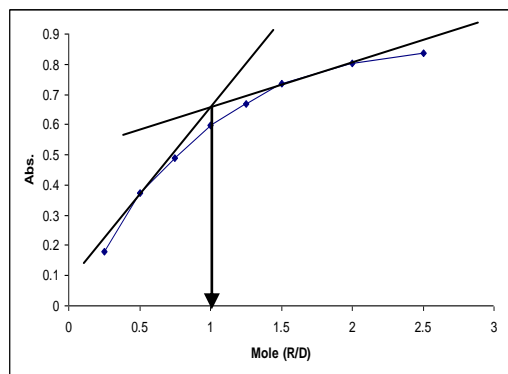

Fig. 2: Mole ratio plot of the reaction between diazotized Procaine HCl and chromatropic acid ($1.38 \times 10^{-3} \text{M}$)

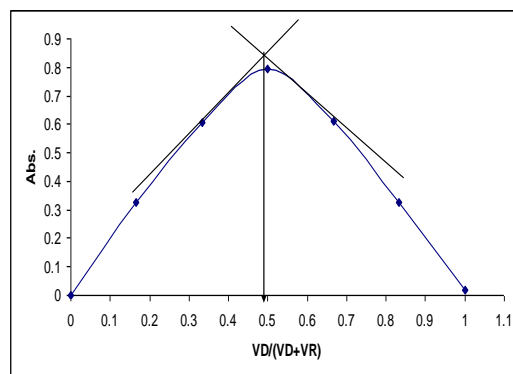
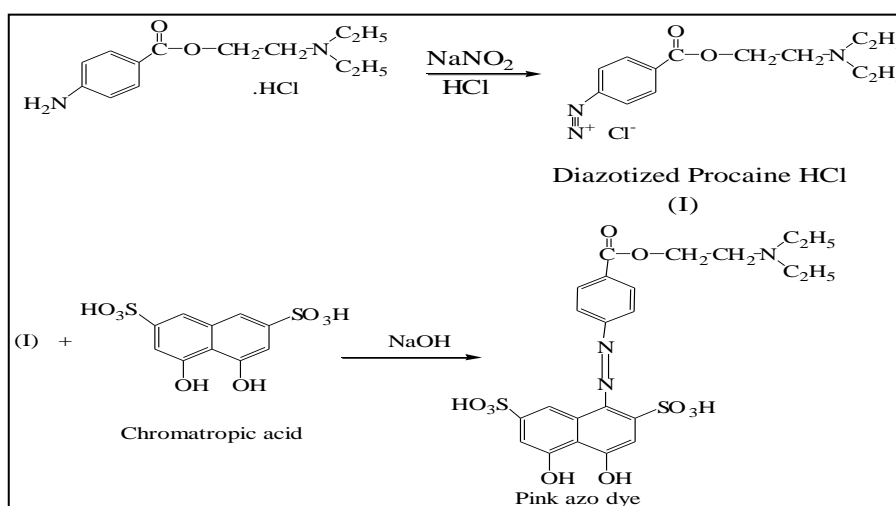

Fig. 3: Continuous variation plot of the reaction between diazotized Procaine HCl and chromatropic acid ($1.38 \times 10^{-3} \text{M}$)

A reaction subsequent based on the above results is shown in Scheme (1).



Scheme (1): reaction sequence

The product formed was soluble in water. The apparent stability constant was calculated by comparing the absorbance of a solution containing stoichiometric amount of diazotized Procaine HCl ($1.832 \times 10^{-3} \text{M}$) and chromatropic acid ($1.83 \times 10^{-3} \text{M}$) (A_S) with that of a solution containing a five-fold excess of chromatropic acid reagent (A_m) and according to analytical procedure. The average stability constant (K) = $7.528 \times 10^4 \text{ L.mol}^{-1}$, where is $[K = (1-\alpha) / \alpha^2 C]$ and $\alpha = A_m - A_S / A_m$ [29].

The regression equation obtained, and the analytical features of the procedure are summarized in (Table 1). It is also

summarized the main performance of the flow procedure developed for Procaine HCl determination in order to make an effective comparison between the two approach.

FIA-spectrophotometric determination

The batch method for the determination of Procaine HCl was adopted as a basis to develop FIA procedure. The manifold used for the determination of Procaine HCl was designed to provide different reaction conditions for magnifying the absorbance signal generated by the reaction of the diazotized Procaine HCl

with chromatropic acid in sodium hydroxide medium. Maximum absorbance intensity was obtained when the sample (diazotized Procaine HCl $500 \mu\text{g}\cdot\text{ml}^{-1}$) was injected into a stream of chromatropic acid and then

mixed with sodium hydroxide as given in (Figure 4). The influence of different chemical and physical FIA parameters on the absorbance intensity of the colored product was optimized as follows:

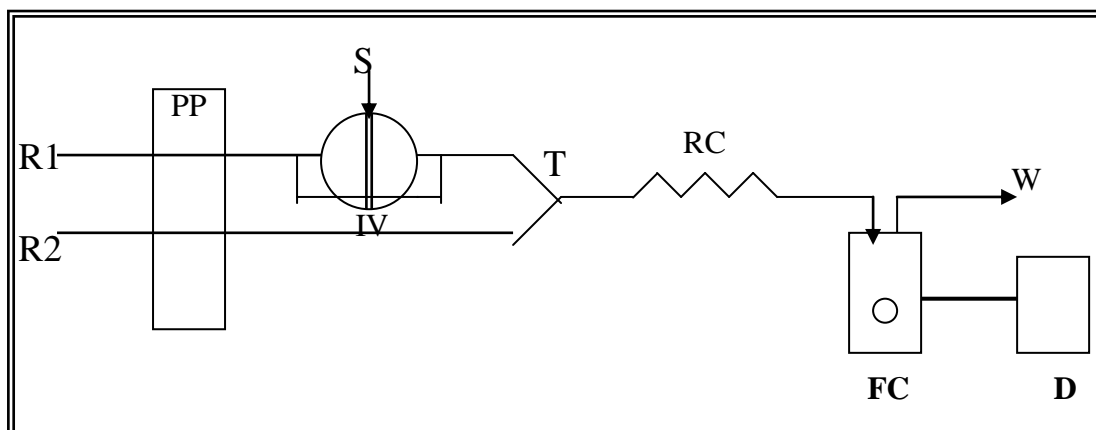

Fig. 4: A schematic diagram of FIA manifold

Where: R1 and R2, solutions of chromatropic acid and sodium hydroxide respectively; PP =peristaltic pump; S= injection sample diazotized Procaine HCl; IV= injection valve; T= T-link; RC= reaction coil; FC= flow cell; D= detector; W= waste.

Optimization of chemical parameters

The effect of various concentrations of Hydrochloric acid (0.1-4M) were studied for the formation of diazotized Procaine HCl in the presence of sodium nitrite, 1M HCl seems to be optimum as shown in (Figure 5).

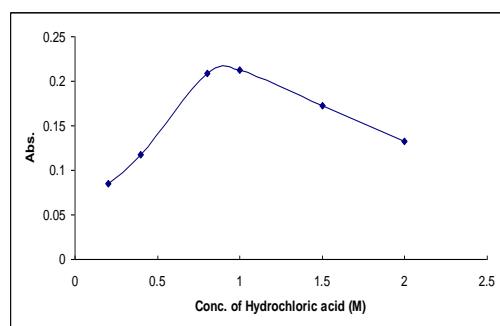

Fig. 5: The effect of the concentration of hydrochloric acid in (M)

The effect of various concentrations of chromatropic acid was investigated. A concentration of (0.07% w/v) chromatropic acid, gave the highest

absorbance and was chosen for further experiments as shown in (Figure 6).

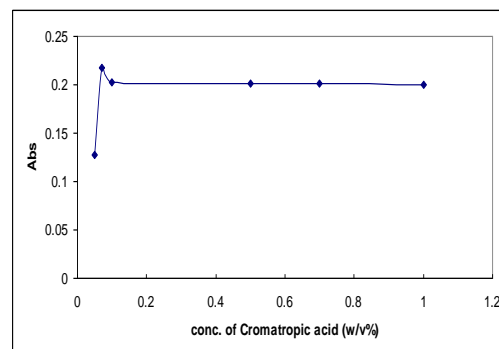

Fig. 6: The effect of the concentration of chromatropic acid reagent in (0.7M) of NaOH

It was observed that the reaction between diazotized Procaine HCl and chromatropic acid depends on alkaline medium, therefore the effect of different concentrations of sodium hydroxide was studied and 0.7M was found to be the optimum as shown in (Figure 7).

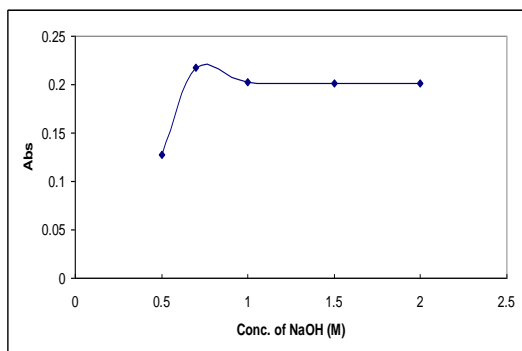

Fig. 7: The effect of the concentration of sodium hydroxide in (M)

Optimization of manifold parameters

The effect of total flow rate on the sensitivity of the colored reaction product was investigated in the range of 0.6-4 ml min⁻¹. The results obtained showed that a total flow rate of 2.4 ml min⁻¹, (1.2 ml min⁻¹ in each line) gave the highest absorbance as shown in (Figure 8), and was used in all subsequent experiments.

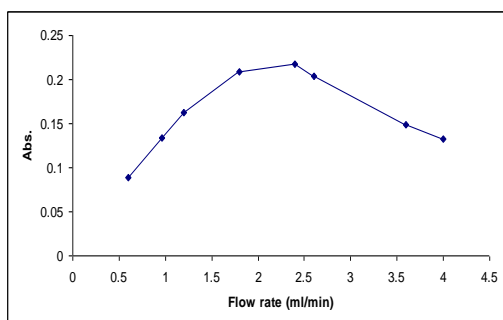

Fig. 8: The effect of the total flow rate (ml/min)

The volume of the injection sample was varied between 50-250 μ l using different length of sample loop. The results (Figure 9) obtained showed that injected sample of 150 μ l gave the best absorbance.

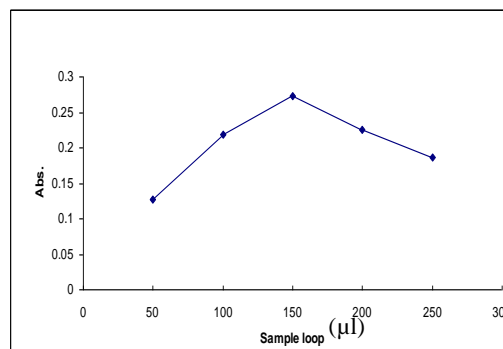

Fig. 9: The effect of the injection loop (μ l)

The coil length is an essential parameter that affects on the sensitivity of the colored reaction product and was investigated in the range of 25-250 cm. The results obtained showed that a coil length of 100 cm gave the highest absorbance as shown in (Figure 10) and was used in all subsequent experiments.

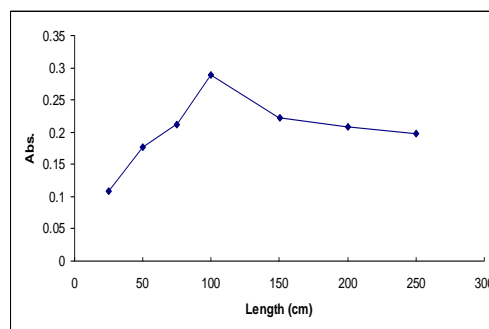

Fig. 10: The effect of the length of the reaction coil in (cm)

The reaction time is also an important parameter that affected on the sample throughput and was investigated by calculating the interval time between the sample injection and the appearance of the end of the signal. The reaction time of each sample was 51 sec, therefore the sample throughput was 70 samples per hour.

Table 1: Analytical characteristics of the procedure that developed for the determination of Procaine HCl

Parameters	Batch procedure	FIA procedure
Regression equation	Y=0.0446x+0.0511	Y=0.0044x+0.2338
Linear range ($\mu\text{g ml}^{-1}$)	1-40	5-400
Correlation coefficient, r^2	0.9982	0.9953
Limit of detection ($\mu\text{g ml}^{-1}$)	0.874	3.75
Relative standard deviation (RSD) %	0.96	1.08
Average of recovery %	99.63	98.91
Molar absorptivity ($\text{L mol}^{-1}\text{cm}^{-1}$)	1.2156×10^4	1.200×10^4
Sandell's sensitivity ($\mu\text{g cm}^{-2}$)	22.42×10^{-3}	22.7×10^{-2}
Sample through-put (hr^{-1})	6	70

Analytical characteristics

Analytical characteristics such as linear range, detection range, correlation coefficient and relative standard deviation (RSD) of each method were determined under the optimized conditions that are shown in (Table 1). In comparison of the batch with the FIA procedure, the later is more convenient than the former method because of its speed (sample through-put of 70 injection h^{-1}), wider linear range of calibration graph, and good recovery were obtained.

Analysis of pharmaceutical products (injection samples)

The standard addition method was applied for the quantitative determination of Procaine HCl in injections. Two types (different origins) of injections preparations containing Procaine HCl in procaine penicillin were analyzed and as shown in (Table 2). It was found that, when the proposed method was applied directly to the determination of procaine HCl in injections , a high recoveries were obtained, this might be due to the interference from benzyl penicillin that present in injections. Therefore, a standard additions method was applied (Figure 11 & 12) which involves adding increment volumes (0-7 ml) of a standard solution of 100 $\mu\text{g.ml}^{-1}$ and (0- 5 ml) of standard solution of 60 $\mu\text{g.ml}^{-1}$ of diazotized Procaine HCl to a fixed volume

sample (0.2 ml of 500 $\mu\text{g.ml}^{-1}$ and (1.5 ml of 40 $\mu\text{g.ml}^{-1}$) of diazotized pharmaceutical preparations for both batch and FIA methods and employing the conditions described under procedure .They gave a good accuracy and precision (Table 2).The proposed method was compared successfully with the British pharmacopeia's standard method [1].

Table 2: Application of the standard addition method for both batch and FIA and official methods for the determination of Procaine HCl.

Injection samples	Standard addition method				Official method Rec.%
	Batch method ($\mu\text{g/ml}$)		FIA method ($60 \mu\text{g/ml}$)		
	Rec.%*	RSD%*	Rec.%*	RSD %*	
Procaine benzyl penicillin injection (300 mg Procaine penicillin)-Indian (I)	100.00	1.47	100.00	1.390	101.50
Procaine benzyl penicillin injection-(800 mg Procaine Penicillin)- (II)	100.00	1.93	100.00	0.960	99.82

*For five determinations

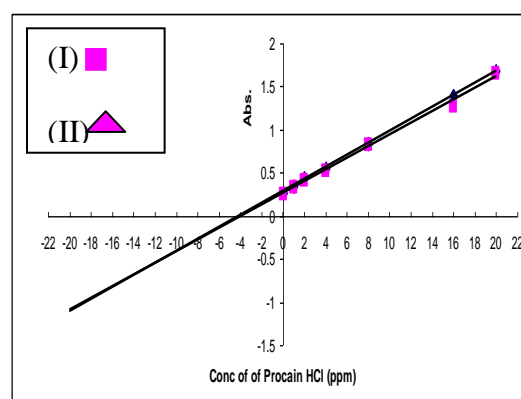

Fig. 11: the standard addition method For the batch method

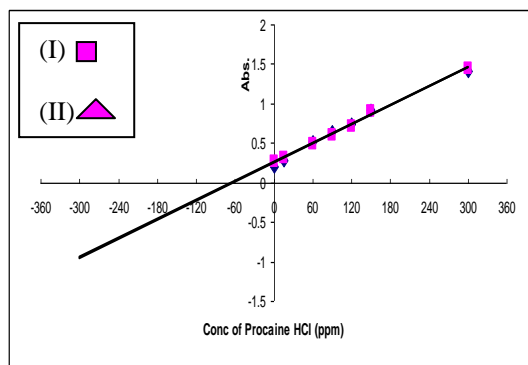

Fig. 12: the standard addition method for the FIA

Conclusion:

Batch and FIA spectrophotometric method were proposed for the determination of Procaine HCl in pure and in pharmaceutical preparations. These methods have the advantage of simplicity, speed, accuracy and the use of inexpensive equipment. The speed of the proposed methods and its precision make them suitable for the quality control of formulations containing this drug. The wide linear range of the proposed methods that obeyed Beer' law gave a good application for the pharmaceutical preparation, and can be used as a reliable and advantageous alternative to the other previously explored methods for routine analysis of Procaine HCl in pharmaceutical samples.

References:

- 1- "British Pharmacopoeia", 2007, the Stationery Office on behalf of the Medicines and Healthcare products Regulatory Agency (MHRA). London. 5thed.
- 2- Alfred, G., Theodore W. and Alan S. 1990, "Goodman and Gilman's, The Pharmacological Basis of Therapeutics", 8th ed., New York: Pergamon Press. 311.
- 3- Meredith S.L. and James S.T, 2002, "Stability-indicating HPLC assays for the determination of prilocaine and procaine drug combinations" J. Pharm. Biomed. Anal., 30, 1, 49-58.
- 4- Tadashi U., Hiroshi T and Masanori A., 2000, "Determination of Procaine Hydrochloride and Dibucaine Hydrochloride in lotions, milky lotions and creams by HPLC" J. SCCJ, 34,3, 261-266.
- 5- Nianbing L.I., Duan J. and Chen G., 2003, "Determination of trace Procaine Hydrochloride by differential pulse adsorptive stripping voltammetry with a Nafion modified glassy carbone electrode", Anal. Sci., 19, 12, 1587-1592.
- 6- Wang C.Y., Hu X.Y, Jin G.D. and Leng Z.Z., 2002, "Differential pulse adsorption voltammetry for determination of Procaine Hydrochloride at a pumice modified carbone paste electrode in pharmaceutical preparations and urine", J. Pharm. Biomed. Anal., 30, 1, 131-139.
- 7- Wu W., Wang H., Chen F. and Hu S., 2006, "Electrochemistry and voltammetry of Procaine using carbon nanotube film coated electrode", Bioelectrochemistry, 68, 2, 144-149.
- 8- Zhang X., Zhao D., Feng L., Jia L. and Wang S., 2010, "Electrochemical sensor for procaine based on a glass carbon electrode modified with poly-amidosulfonic acid and multi-waled carbon nanotubes", Microchimica Acta, 169, 1-2, 153-159.
- 9- Michalska K., Pajchel G. and Tyski S., 2004, "Capillary electrophoresis method for simultaneous determination of Penicillin G, Procaine and dihydrostreptomycin in veterinary drugs", J. Chromo. B., 800, 1-2, 203-209.
- 10- Yuan J., Yin J. and Wang E., 2007, "Characterization of Procaine metabolism as probe for the butyryl

- chloinesterase enzyme investigation by simultaneous determination of Procaine and its metabolite using capillary electrophoresis with electrochemiluminescence detection" J. Chromo. A, 1154, 1-2, 368-372.
- 11- Nerin C., Garnica A. and Cacho J., 1986, "Indirect determination of nitrogenated drugs by atomic absorption spectrophotometry", Anal. Chem., 58,13, 2617-2621.
- 12- Sakai T., Teshima N. and Takatori Y., 2001, "Ion association titration for the determination of local anesthetics in pharmaceuticals with tetrabromophenolphthalein ethyl ester as indicator", Anal. Sci., 17, 9, 1105.
- 13- Liang L.G., Zeng L.W., and Liu H.D., 2007, "Determination of Procaine Hydrochloride injection by GC", West China- J. pharm. Sci., 22, 5, 586-587.
- 14- Sun Y., Ma L., Wang H.Y. and Tang B., 2002, "Determination of Procaine Hydrochloride by Fluorimetry", Guanq Pu Xue Guanq Pu Fen Xi, 22, 4, 637.
- 15- Chen X.W., Song X. and Wang J.H. 2006, "A sequential injection flurometric procedure for the determination of Procaine in human blood and pharmaceuticals", Anal. Bioanal. Chem., 385, 4, 737-741.
- 16- Garcia Sanchez F., Ramosrubio A.L and Crucesblanco C., 1988, "Enhanced fluorimetric determination of Procaine in pharmaceutical preparations by aqueous B-cyclodextrin inclusion and non aqueous competitive action", Anal. Chim. Acta, 205, 139-147.
- 17- Pasekova H. and Polasek M., 2000, "Determination of Procaine, benzocaine and tetracaine by sequential injection analysis with permanganate induced chemiluminescence detection", Talanta, 52, 1, 67-75.
- 18- Wang A.J., Fan J., Feng S.L. and Cui F.L., 2005, "Spectral Study and determination of metoclopramide and procaine hydrochloride by sequential injection analysis", Guanq Pu Xue Yu Guanq Pu Fen Xi, 25, 3, 432-437.
- 19- Mo, Z., Luo J., Long X. and Xia Z., 1997, "determination of Procaine hydrochloride by ion-pairing flow injection analysis with piezoelectric detection", J. Anal. Chem., 358, 4, 556-558.
- 20- Li N., Chi Y., Wang J., Duan J. and Chem G., 2003, "Determination of Procaine Hydrochloride using flow injection inhibitory chemiluminescence", Luminescence, 18, 3, 125-130.
- 21- Zhang X.R., Baeyens W.R.G., Vanderweken G., Calokerinos A.C. and Imai K., 1995, "Chemiluminescence determination of some local anesthetic" Anal. Chem. Acta., 303, 14, 137-140.
- 22- Amin A.S. and El-Didamony A.M., 2003, "Colorimetric determination of Benzocaine, Lignocaine and Procaine Hydrochlorides in pure form and in pharmaceutical formulations using p-Benzoquinone", Anal. Sci. 19, 10, 1457.
- 23- Liu L.D., Liu Y., Wang H.Y., Sun Y., Ma L. and Tang B., 2000, "Use of p-dimethyl aminobenzaldehyde as a colored reagent for determination of Procaine Hydrochloride by spectrophotometry", Talanta, 52, 6, 991-999.
- 24- Santoni G., Mura P., Pinzauti S., Lombardo E. and Gratteri P., 1990, "Simultaneous UV spectrophotometric determination

- of Procaine Hydrochloride and phenazone in an otic formulation”, Inter. J. Pharm., 64,2-3, 235-238.
- 25- Novakovic J. 1989, “Spectrophotometric determination of Procaine Hydrochloride by means of iron(+3)-4-aminobenzohydroxamic acid complex”, Boll Chim Farm, 128, 12, 370-372.
- 26- Chen Y., Tian F. and Song M., 2009, “Spectrophotometric determination of Procaine Hydrochloride with hemoglobin as catalyst”, J. Anal. Chem., 46, 4, 366-370.
- 27- Carmona M., Silva M. and Perez-Bendito D., 1992, “A selective and sensitive kinetic method for the determination of Procaine and Benzocaine in pharmaceuticals”, J. Pharm. Biomed. Anal., 10, 2-3, 145-152.
- 28- Xiao Y., 2003, “Spectrophotometric determination of Procaine Hydrochloride in pharmaceutical products using 1,2-naphthoquinone-4-sulfonic acid as the chromogenic reagent”, Spect. Acta., 59, 13, 3103-3110.
- 29- Al-Abachi, M.Q. and Al-Ghabsha, T.S. 1983, “Fundamentals of analytical chemistry”. Press of Mousl University, 346.

التقدير الطيفي لهيدروكلوريد البروكائين في المستحضرات الصيدلانية بواسطة طريقتي الدفعة والحقن الجرياني باستخدام تفاعلات الازوتة والاقتران

مؤيد قاسم العباي * وسن عبد الامير الازري * هند صادق الورد *

*قسم الكيمياء-كلية العلوم -جامعة بغداد-بغداد-العراق

الخلاصة:

يتضمن البحث تطوير طرائق طيفية جديدة وبسيطة للتقدير الكمي لمقادير ضئيلة من هيدروكلوريد البروكائين في المحاليل المائية والحقن باستخدام طريقتي الدفعة التقليدية وتقنية الحقن الجرياني. تعتمد الطريقتين على تفاعل الازوتة والازدواج لهيدروكلورايد البروكائين المؤزوت مع كاشف حامض الكروموتروبيك في وسط قاعدي حيث تتكون صبغة ارجوانية محمرة مستقرة وذائبة في الماء اعطت اعلى قمة امتصاص عند طول موجي 508 نانوميتر. تشير منحنيات الامتصاص مقابل التركيز بان قانون بير ينطبق ضمن مدى التراكيز 1-40 و 5-400 مايكروغرام.مل⁻¹ من هيدروكلورايد البروكائين وبحد كشف 0.874 و 3.75 مايكروغرام.مل⁻¹ من هيدروكلورايد البروكائين لطريقتي الدفعة والحقن الجرياني على التوالي وبمعدل نمذجة 70 نموذج في الساعة، تم دراسة الظروف المثلى للتفاعل وجميع المتغيرات الكيميائية والفيزيائية بدقة، طبقت الطريقتين بنجاح على الحقن الحاوية على هيدروكلورايد البروكائين .