

Design and construction Optically Gas Laser

*Nahla.A. Al Jabar**

*Kamal.H.Latif **

*Bushra R.Mhdi**

*Huda A. Al Jabar***

*Basher R.Mhdi**

Received 2, June, 2011

Accepted 26, June, 2012

Abstract:

In this work the design and construction of a flash photolysis pulsed HCl laser was presented. The parameters of the pumping source and discharge current density was obtained, which sufficient to shift the flash lamp spectrum towards uv portion of spectrum. The maximum pulse laser energy parameters was measured.

Total pressure and ratio of active gases to optimized the output pulse energy were measured , where at 125 mbar of total pressure and 1:7:14 Cl₂:H₂: He ratio, the laser energy was measured to be 200 mJ at pumping four flash lamps energy in the order of 6400J .

The resonator consists of copper a near hemispherical mirror with the radius of curvature 3m coated by gold and reflectivity 98%,the output coupler sapphire mirror of 63% reflectivity . Total efficiency of the system was measured to be 0.0125% .

Key words: Pulse gas laser, Hcl laser.

Introduction:

The chemical laser proved to be one of the most intensive laser systems during the last five decades. This is due to many facts, namely; being among the most powerful, high efficiency lasers, reaching 60 KJ in pulse and 1 KW in CW modes [1,2].

The high energy of chemical laser draw attention of many researchers to develop systems for many fields of applications particularly for industrial and military uses. The wavelength of such kind of lasers fall in the range (2-5) μ m which makes them of immense importance in the far field laser target treatment, this is due to the limited attenuation for this range of wavelength in space is very low [3]. Chemical compounds are able to store large amount of energy which may be partially released in exothermic chemical reactions [4].

A chemical laser is a laser in which population inversion is directly produced by an elementary chemical

reaction. Accordingly, a chemical laser is capable of yielding very-high power densities with significantly small reaction initiation energies in comparison to the emitted laser energy [5]. They operate on a rotational-vibrational transition in molecule. This is because many exothermic gas-phase reactions liberate their energy through a stretching vibration in the newly formed bond [6].

In chemical laser, the initiation energy only serves to prepare chemical species that react exothermically to produce the lasing active medium. Initiation efficiency of chemical lasers being as high as $\geq 200\%$, whereas for solid state and CO₂ gas lasers it is $\leq 5\%$ and 25% respectively[7,8].

The first chemical laser was demonstrated by V.V.Kasper et.al. in 1965[9]. It has used the flash lamp to initiate HCl laser using chain reaction of (Cl₂ – H₂) mixture. The flash lamp

* Ministry of Science and Technology.

** University of Baghdad/College of Science for Women.

delivered an input energy of about (3800J) which was found to yield a laser pulse of 20J energy.. In the 1968 the same previous research team utilized the chain reaction of (Cl₂ – H₂) mixture. The flash lamp and laser tube both were made of quartz. They were placed on the two axes of an elliptical aluminum reflector. the input energy of the lamp was about 1100J to give about 12J laser output pulse [10].

During the eighties, the technique of using lasers to initiate the reaction instead of flash lamps appears in the work of. Hirokozn, 1984. The chain reaction, which is initiated by UV flash using F₂-H₂ mixture, to achieve (14.6) J/Pulse laser output energy at (0.7 atm) [6].In 1986 A.S.Bashkin, utilized the chain reaction for (D₂-F₂) mixture, using flash lamp.In 1996 B.G.Bravy, utilized the chain reaction for F₂-H₂ mixture, initiated by flash lamp to get 1KJ output laser energy at total pressure of 0.7 atm, with 50 liter. The beam divergence was 10⁻⁴ rad [10].A ClF and H₂ mixture chain reaction, initiated by using XeCl laser (308 nm), 50 J/ℓ laser energy pulse, was utilized by E.B. Gorden in 1997 [11].

Materials and Methods

The first chemical laser has been made on the basis of a reaction proceeding in the mixture of a molecular hydrogen and a chlorine H₂+Cl₂. The aforementioned, process is a classical example of a chain chemical process. It proceeds in the following manner: The chlorine molecules are decomposed into atoms under the action of uv radiation. These atoms will be responsible for initiating the reaction with a long chain as follows[12]:

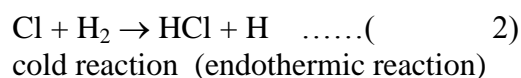

$$-\Delta H = 1 \text{ K cal/mol} \quad E_A = 5.5 \text{ K cal/mol}$$



hot reaction (exothermic reaction)

$$-\Delta H = 45.1 \text{ K cal/mol} \quad E_A = 1.8 \text{ K cal/mol}$$

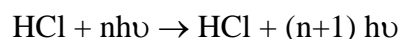

The HCl molecules are produced non excited in the first link of the process since no energy is being released here. However, a quite large amount of energy is released approximately 2eV in each elementary act in the second link, therefore, the HCl molecules are excited and consequently, the coherent emission is produced. Firstly, the chain process was realized just in the first chemical laser. However, as it turned out, the energy expenses for the production of chloride atoms was thousand times larger than the energy of the generated coherent emission.

The first link takes place slowly in that reaction. Accordingly, the rate of the chain is slower than the rate of processes which are responsible for deactivating the molecule excitation. The chemical reaction in the hydrogen chloride mixture is non-chain from the laser point of view.

This mechanism has three important effects on the operation of the laser, first of all: the rate of the pumping reaction (3) is limited by that of the slower preceding reaction (eq. 2) because of its activation energy of 5.5 Kcal/mol [12]. Second: the inversion due to vibration ally excited HCl produced in reaction (eq.3) is necessarily diluted by “cold” HCl produced concurrently in reaction (eq. 2) for which (-ΔH+E_A) is insufficient to excite HCl V=1. Third: the cyclic chain provided by reactions eqs 2, 3

multiplies many-fold the number of pumping reaction steps 3 that can be obtained for each produced chlorine atom. It is implied that only a small number of input photons in the form of initiating light might be sufficient to produce a far large number of output photons, which are excited [six vibration levels HCl ($V=0-5$)].

Techniques for Initiating Chemical Laser Reactions

Some types of reaction initiation techniques, which are applied to the gases either before or after mixing, are listed below-

A: Flash Photolysis Initiation:-

This method has been used for initiation of reaction in pulsed HF and HCl chemical lasers. Ultraviolet light is needed for flash photolytic initiation. The absorption spectra of all (H_2 , F_2 , Cl_2) has been measured. It indicates that the F_2 , Cl_2 molecules can dissociate by the flash or not [5].

A small portion of the flash lamp light is produced in the useful wavelength region. It can be absorbed by the fluorine molecule, or actually absorbed reactant. Consequently, the losses in the flash lamp make the overall efficiencies low, ($\eta_{lamp}= 13\%$). However, photolysis initiation will produce specially uniform reaction. The electrical efficiency is greater than 4% [12]. The laser pulse is shorter than the flash lamp duration, and the time delay between initiation of the flash lamp and the laser threshold is quite variable. The pulse of the flash lamp and the laser pulse are shown in Fig.(1) [4].

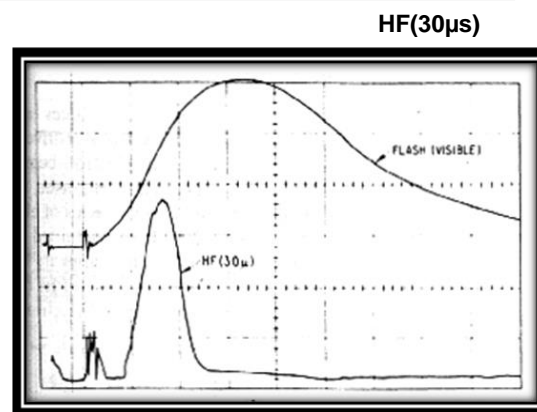

Fig. (1) the pulse of the flash lamp and the laser pulse as shown on the scope [4].

The flash photolysis is the simplest way of reaction for the active medium, although it is not the most efficient one. The pattern of the laser pulse shape is almost homogenous and the intensity is uniform. Therefore, it is suitable for far field target treatment, due to the limited beam divergence [4].

Increasing the number of flash lamps will increase the laser pulse energy. This is the most advantage characteristic of using flash lamp technique. It is especially true when the flash lamps are fixed outside the active medium (using Quartz tube). In addition, in such case, there is no interaction between the pumping source and the active medium. This will increase the pressure to higher range, than another pumping mechanism. The increasing of pressure will already increases the laser energy [10]. The electrical circuit, which can be used, is very simple and more reliable than other mechanism.

B: Electrical – Discharge Initiation:-

An electrical discharge provides an efficient means for initiating reaction in chemical laser which may be accomplished through either transverse or longitudinal discharge configuration [4].

C: Electron – Beam Initiation :-

HF chemical laser can lase with electrical laser efficiencies in excess of 100% by using a mixture of H₂ and F₂. HF laser initiated by using intense e-beams are considered of especial high efficiencies and can produce high – output energy [13].

D: Laser – Photolysis initiation :-

Another technique for photolysis initiation is to irradiate the H₂–F₂ mixture with a frequency doubled ruby laser pulse at 347 nm. The ruby–laser pulse which is directed longitudinally along the HF laser axis, photolysis as small percent of the F₂ to initiate the reaction [4].

Experimental work and System Control

The operation procedure of the laser system is electronically controlled through an electronic circuit. First of all, the control circuits triggered pneumatics value that is jointed to the chlorine bottle. The trigger time lasts for 100-250msec. The variability of the trigger time is to control the chlorine

pressure that pushes into the active medium.

Experimentally, when the chlorine bottle fuelled to about 1bar and the active medium cavity evacuated to 10⁻² mbar, then the chlorine pressure reaches (25-75) mbar. By these the operation time of the valve was varied from (100-250) msec respectively .Furthermore, it seems to be very reliable and simple to control. Secondly, after about 100msec, the second valve of hydrogen-helium which is joint with the bottle of mixing, will open within a time varied from 0-300msec. The He-H₂ is mixed primary using regulated flow meters to control the gas mixing ratio precieessly.

The third trigger was applied into thyristor switching circuit. It sends the pulse to a high voltage transformer within a time varied from 0.4-20msec. The time of trigger lasts for nearly 80µsec. The generated pulse was used to break down the gas resistance at four flash lamps so that charged capacitors will discharge through them.

The H.V discharge trigger circuit and the electronic controlling circuit are shown in Fig.(2).

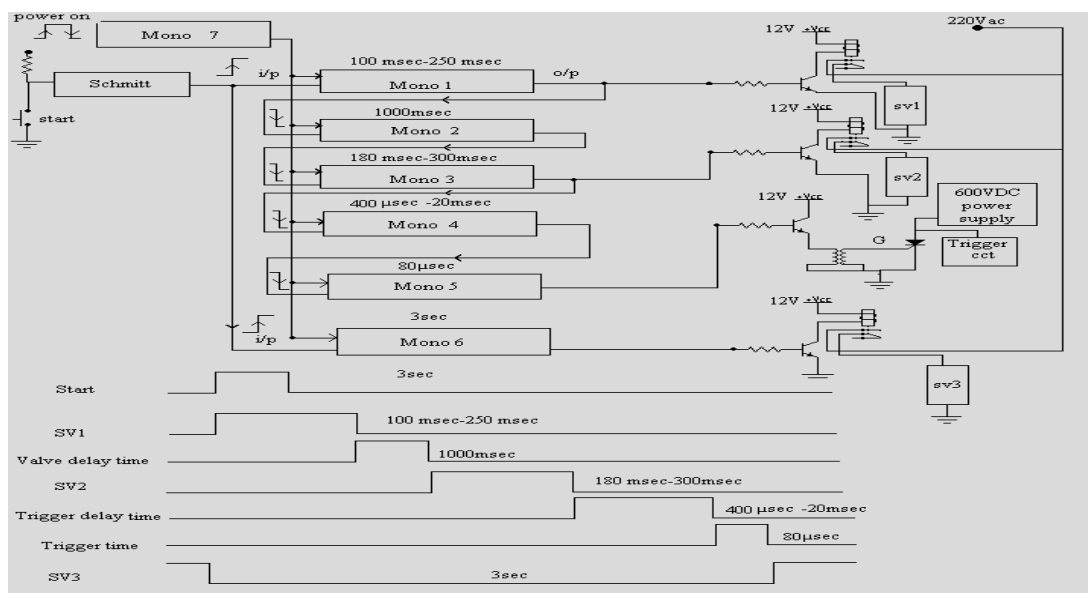

Fig. (2) The electronic equivalent circuit of the control system

Laser Cavity Design

The active medium consists of a high optical quality quartz tube of 10cm diameter and 100cm length. The two ends were closed by two o-ring

aluminum window holders designed and constructed to fit and to seal the two ends of the quartz tube.

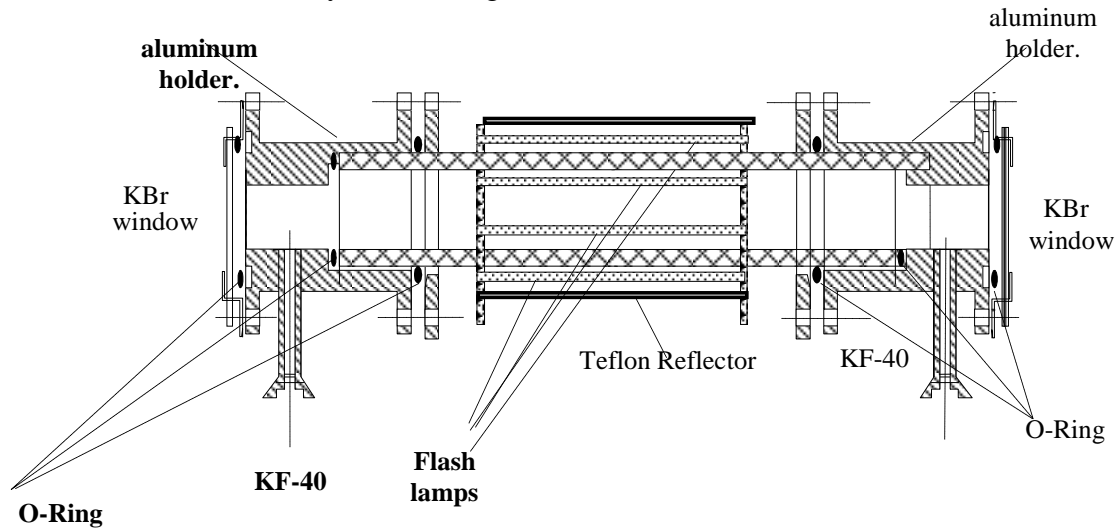
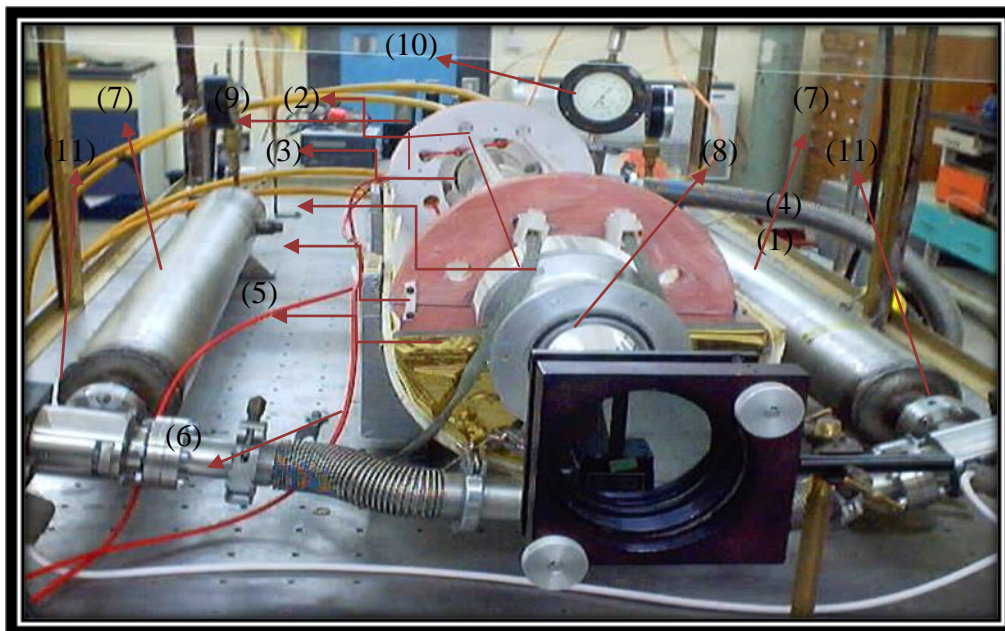

Fig. (3) Laser cavity

A vacuum hood was used to evacuate and pull the gases if there are any leaks. The active system with the resonator fixed inside the hood chamber which is consisted of 3m

(radius of curvature) gold coated mirror and flat sapphire window of 63% reflectivity. Figs.(4), (5) shows pictures of the chemical laser system.



Fig(4)The system where the trigger and control circuits are shown.

- 1- Teflon Reflectr 2- Flash lamps 3- Laser cavity(quartz tube)
- 4- KBr window 5- aluminum holder. 6- tube coneaction
- 7- gases mixture 8- gold coated mirror 9- flat sapphire window
- 10- gas gage 11- Pneumatic valves

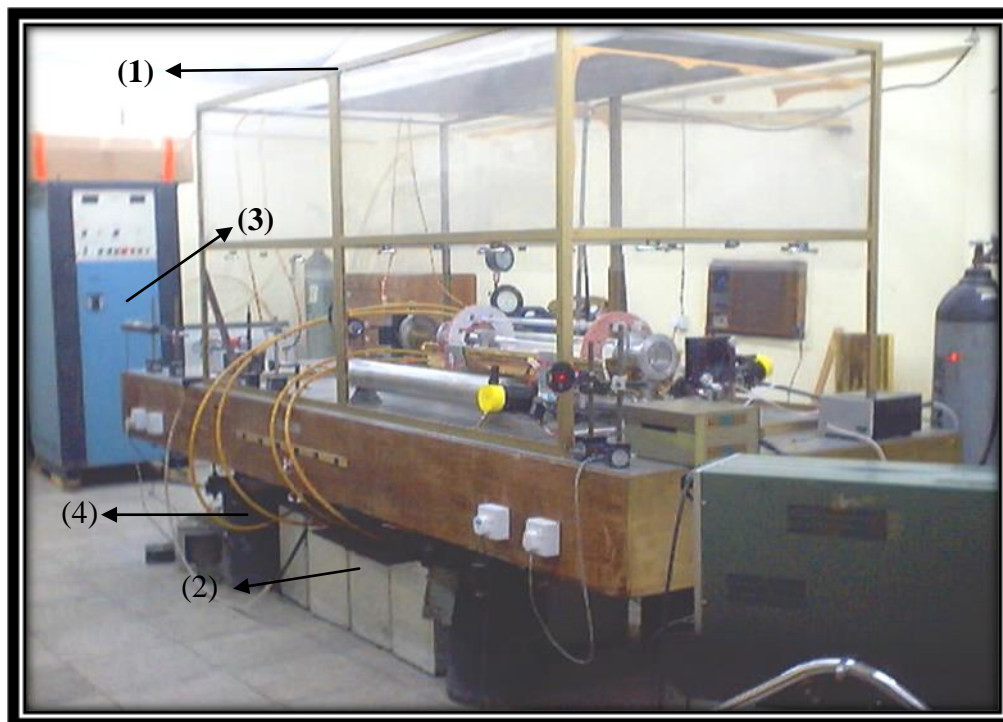

Fig(5)The whole system fixed in a chamber where a ventilation hood is assembled at the top of the chamber.

1-Ventilation hood 2- capacitors 3- power supply 4- rotary pump

Results and Discussion:

The energy of the laser pulse was recorded using a calorimeter type (ED-500 from Genetic Corporation). The maximum output energy was 200 mJ at input energy of (6400 J). The laser pulse shape is shown in Fig.(6). Many parameters are varied in order to get the optimum conditions for the laser pulse. The result of the laser pulse as a function of the total pressure for the mixed gases, satisfying the optimum ratio of the active gases 1:7:14 (Cl_2 , H_2 , He) are shown in figure (7). It is obvious that the laser energy depends dramatically on the total pressure. The laser energy is increased from 25mJ at 50mbar of total pressure to 200mJ when the pressure is increased to 125mbar, then it is reduced to 150mJ slowly when the total pressure is increased to 175mbar. A rapid reduction in the laser pulse energy occurred when the total pressure is increased to 225mbar. Our

explanations can be divided into two main parts .

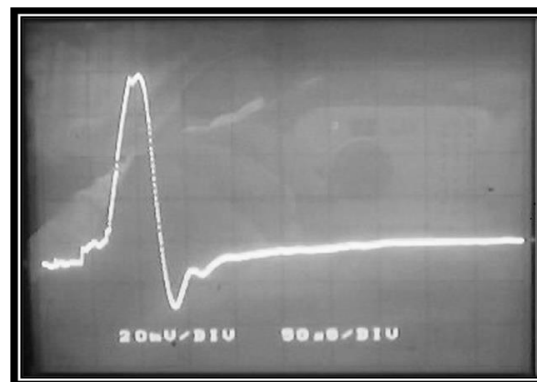

Fig. (6) The recorded laser pulse energy

1. In the first part, the energy pulse increases up to 200mJ when the pressure reaches 125mbar and consequently, depends on the amount of the active product of molecules at certain electrical energy delivered to the active volume.

2. The second part of the curve can be explained as follow Since the electrical energy is fixed at 6400J, while the

amount of active molecules increases due to the increase in the total pressure, the electrical energy was not enough to dissociate the excess molecules. On the other hand, the excess undissociated molecules will greatly affect the laser pulse energy. This is due to the

collisions between the excited active molecules and the undissociated ones. From the explanation above, we expect that when the electrical energy increases to more than 6400J, the optimum laser pulse energy will shift towards the higher total pressure.

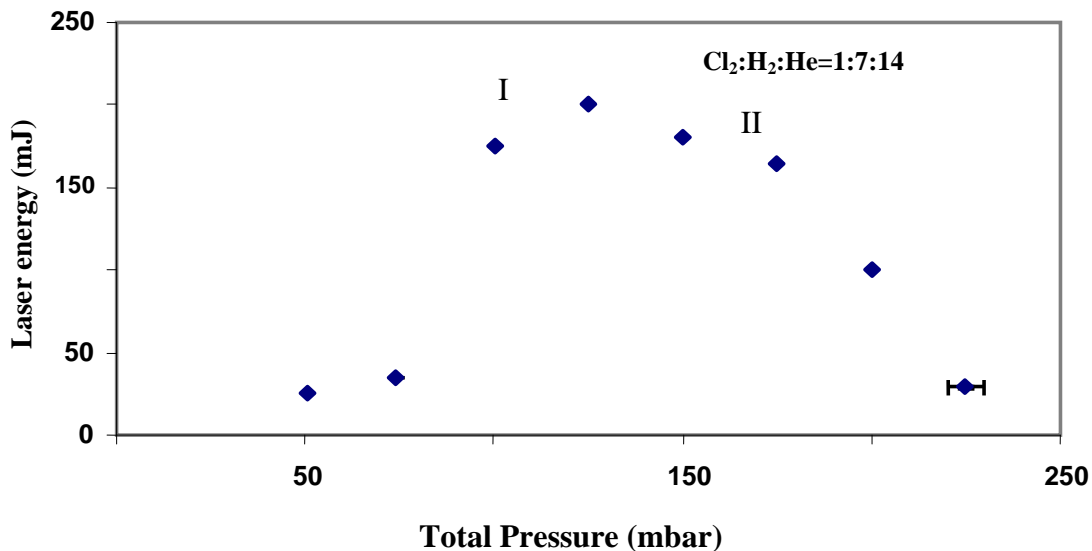

Fig.(7) The output pulse energy as a function of the total gases pressure

Conclusions:

Throughout the experimental research, we conclude the following points.

1. When the chlorine to Hydrogen ratio increased to more than 1:3, a violet glow inside the active medium was appeared after activating the system. This glowing lasts for 3 seconds. This kind of glowing is due to the reaction between Cl_2 molecules in the excited state and the helium atoms which produced a dimmer in metastable state of long life time (HeCl).
2. The reaction of HCl products, generates a shock wave due to the fast reaction of the active gases after the flash initiation. This shock sonic wave could causes an explosion was in the laser cavity.

3. The appearance of the shock wave severely affects the laser pulse. Accordingly, it is essential to reduce the shock wave to minimum value. This can be achieved when the pulse of the flash lamp is shorter than the time period of the sonic wave traveling toward the center of the tube.

Reference:

- 1- Vorob'ev, A. P. and Iskhakov, V. A., 1998, "Laser Diagnostics of Combustion Processes: From Chemical Dynamics to Technical Devices", IEEE J.Quant. Elec.,28 (7): 589-593.
- 2- Mirels, H. and Spencer. D. J. 1971, "Laser-induced fluorescence study of the hydrogen atom formation dynamics in the 248 nm gas phase photodissociated of vibrational state selected water

- (H₂O)"IEEE J. Quant. Elec. , 7 (11):513-522.
- 3- Rizhsky Pereulok, 1983, "Weaponry in space : The Dilemma of Security ", Mir Publishers, 2 Prevy, 1-110, GSP, Moscow, USSR 129820 .
 - 4- .Gross R.W and J.F.Botl(ed) , 1976, "HandBook of Chemical Laser" , John Wiley & Son,3 ed,205.
 - 5- Joseph J.T, 1975, "A theoretical and experimental investigation of mechanism of the hydrogen-fluoride pulsed chemical laser". Ph.D Thesis, Michigan State University, Physics, Optics. Xerox University microfilm.
 - 6- Almuth L., Hans,R. V, Jaip,M and Rajesh, K,2007," Lyman- α photodissociation of CH₃CFCI₂ (HCFC-141b): Quantum yield and translational energy of hydrogen atoms",J. Chem. Sci., 119(4):277–282.
 - 7- Brown, R. A., Laurent ,T. , Maity,D. K.and Vatsa. R. K., 2005," The reaction ND(a₁) + H₂: laser spectroscopic measurement of room-temperature rate constant and H/D atom product branching ratio", Res. Chem. Intermed., 31(1–3):193–203.
 - 8- Gordon E.B., Matyushenko V.I., and Sizov V. D., 1997, " Laser Diagnostics of Combustion Processes: From Chemical Dynamics to Technical Devices", Applied energy: Russian Journal of Fuel, Power and Heat Systems , 35 (3): 81-90.
 - 9- Melchior A., Knupfer P., Ilana B., and Salman R., Laurent T., Hans R. Volpp.P, and Wolfrum J., 1996," Photodissociation of CHF₂Cl at 193 nm: H/Cl and Cl(2P_{1/2})/Cl(2P_{3/2}) Branching Ratios",J. Phys. Chem. 10(10): 13375-13380.
 - 10- Gorski A., Yurkiv V., Bessler W.G.and Volpp H.-R., 2011, "Combined theoretical and experimental studies of H₂ and Co oxidation over the YSZ surface " ,ECS Trans.,12(5):512-522.
 - 11- Bravy B.G., Vasiliev G.K., Kiriganov V.I., Makarov E.F. and Chernysher Y.U.A, 2007, BRAS Physics/ supplement physics of vibrations, 60(2) :117-121.
 - 12- Hanf .A., Volpp. H.-R., Sharma P., Mittal J. P.and Vatsa R. K., 2010, "Ultraviolet photochemistry of buta-1,3- and buta-1,2-dienes: Laser spectroscopic absolute hydrogen atom quantum yield and translational energy distribution measurements",J. Chem. Phys. 133(3): 243-248 .

تصميم وبناء ليزر غازي يضخ ضوئياً

نهلة عبد الجبار* كمال حسين لطيف* بشري رزوقي مهدي*
هدى عبد الجبار** بشير رزوقي مهدي*

*وزارة العلوم والتكنولوجيا
**جامعة بغداد/كلية العلوم للبنات

الخلاصة:

تم في هذا البحث تصميم وبناء منظومة ليزر غازي نبضي يضخ ضوئياً. معلمات مصدر الضخ وكثافة تيار التفريغ حصلنا عليها والتي كانت كافية لحدوث ترحيف طيف مصباح الوميضي نحو طيف المنطقة فوق البنفسجية. أعظم قيمة لطاقة النبضة تم قياسها. الضغط الكلي ونسبة خلط الغازات الفعالة لتثذيب طاقة نبضة الخارجة المقاسة، حيث عند الضغط الكلي 125 mbar لخلطة الغازات الهيدروجين، الكلور، الهيليوم وبنسب خلط (1:7:14) وكانت نبضة ليزر بطاقة حدود 200 mJ بطاقة ضخ لأربعة مصابيح وميضي حوالي 6400 جول.

المرنان مكون من مرآة شبة كروية ومرآة خلفية بنصف قطر تكور 3 متر وهي من النحاس المطلي بالذهب وبنعكاسية حدود 98% إما مرآة الخرج الليزري فكانت نافذة مستوية من السفاير بنسبة انعكاسية بحدود 63%. تم حساب كفاءة المنظومة فكانت 0.0125 %.