



# Inducing Frictional Force to Enhance the Transient Response in Beams

Hamed Khanger Mina<sup>1\*</sup>, Waleed K. Al-Ashtari<sup>2</sup>

## Authors affiliations:

1\*) Mechanical Engineering Department, University of Baghdad, Baghdad-Iraq  
[hamedkham75@gmail.com](mailto:hamedkham75@gmail.com)

2) Mechanical Engineering Department, University of Baghdad, Baghdad-Iraq  
[Waleed.AL.Ashtari@coeng.uobaghdad.edu.iq](mailto:Waleed.AL.Ashtari@coeng.uobaghdad.edu.iq)

## Paper History:

Received: 3<sup>rd</sup> Mar. 2019

Revised: 21<sup>th</sup> Mar. 2019

Accepted: 30<sup>th</sup> April 2019

## Abstract

This paper studies the effect of contact areas on the transient response of mechanical structures. Precisely, it investigates replacing the ordinary beam of a structure by two beams of half the thickness, which are joined by bolts. The response of these beams is controlled by adjusting the tightening of the connecting bolts and hence changing the magnitude of the induced frictional force between the two beams which affect the beams damping capacity.

A cantilever of two beams joined together by bolts has been investigated numerically and experimentally. The numerical analysis was performed using ANSYS-Workbench version 17.2. A good agreement between the numerical and experimental results has been obtained. In general, results showed that the two beams vibrate independently when the bolts were loosed and the structure stiffness is about 20 N/m and the damping ratio is about 0.008. With increasing the bolts tightening, the stiffness and the damping ratio of the structure were also increased till they reach their maximum values when the tightening force equals to 8330 N, where the structure now has stiffness equals to 88 N/m and the damping ratio is about 0.062. Beyond this force value, increasing the bolts tightening has no effect on stiffness of the structure while the damping ratio is decreased until it returned to 0.008 when the bolts tightening becomes immense and the beams behave as one beam of double thickness.

**Keywords:** Frictional Force, Layered Structure, Micro-Slip, Macro-Slip, Dissipated Energy, Asperities of Interface.

## تحفيز القوة الاحتكاكية لتعزيز الاستجابة العابرة في هياكل الحزم المشتركة

حميد خنجر مينة ، وليد خالد الأشترى

### الخلاصة

تدرس هذه الورقة تأثير مناطق الاتصال على السلوك الديناميكي للهياكل الميكانيكية التي تمسكها البراغي، وتسلط الضوء على التأثير الكبير لقوة الاحتكاك غير الخطية المستحثة بين العناصر الهيكلية للتحكم في استجابة اهتزاز الهيكل. تقدم هذه الورقة التحليل العددي والتجريبي للهيكل المعرض للاهتزاز عابر. هيكل ناقي، تم اقتراحه، يتكون من شعاع طبقة يربطان معا بواسطة البراغي. تم إجراء التحليل الرقمي باستخدام ANSYS-Workbench ، الإصدار 17.2 ، في حين تم إجراء البحث التجريبي باستخدام منصة تصنيع مجهزة بأجهزة قياس مناسبة. تم الحصول على اتفاق جيد بين النتائج العددية والتجريبية. أظهرت النتائج أن حزمي الهيكل المقترح سيتران بشكل مستقل عند فقدان البراغي، وتصلب كل قيمة حزمة طبقة 17 N / m مع زيادة البراغي المشدودة تصلب الصلابة إلى القيمة القصوى 88 N / m عند 8330 N عندما تشير نسبة التخميد إلى الحد الأدنى للقيمة 0.008 عند فقدان البراغي، مع زيادة البراغي التي تشد، فإن نسبة التخميد تزداد أيضًا حتى تصل إلى قيمة قصوى معينة 0.062 نانومتر / متر. مع استمرار زيادة تشديد البراغي، ستبقى قيمة الصلابة ثابتة بينما تنخفض نسبة التخميد حتى تعود 0.008 عندما يصبح تشديد البراغي كبيرًا جدًا حيث يتصرف حزمة الطبقات كحزمة واحدة بساكنة مزدوجة. وبالتالي، يمكن استخدام وصلات البرغي لتحسين قدرة التخميد للهيكل من ضبط شد البراغي.



## 1. Introduction

Vibrations can cause considerable damages of the structures and may lead to destroy them. Examples of these problems are the fatigue failure, structural wear and tear, loud noise etc. [1].

In this paper, the ordinary beam of a structure is suggested to be replaced by two beams of half the thickness joined together by bolts. The vibration of these joined beams is controlled by adjusting the tightening of the connecting bolts and hence changing the magnitude of the induced frictional force between the two beams. The ordinary beam and the corresponding proposed one can be seen in Fig (1)

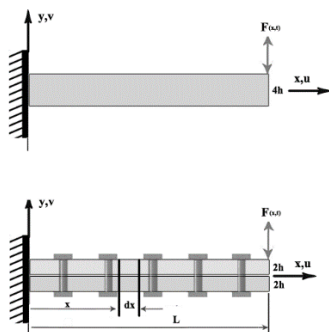

Figure (1): Ordinary cantilever beam and the corresponding proposed beam

Generally, when two beams of a structure are joined by bolts, the asperities at the interface will be overlapped. Due to the different heights of these asperities, the contact will happen at longest asperities, which are tangled and compressed while the shorter asperities have no contact. The contacted asperities will be restricted and need kinetic energy to be released. This acquires the structure certain stiffness and damping capacity. As the pressure between the two beams is increased, the contact number of the contacted asperities is also increased causing to change the structure stiffness and damping. Thus, the bolts tightening can be adjusted to obtain suitable stiffness and damping of the structure.

Damping capacity of the structure is changed with bolts tightening due to inducing frictional force at the interface [2]. The magnitude of the bolts tightening along the beams plays the main role in defining the damping capacity of the structure. The interface pressure due to the bolts is not uniform over the area of contact. The pressure is at maximum under the bolt, and decreases with getting away from the bolt as shown in Fig. (2). Thus, non-uniform distribution of the pressure induces a relative motion between the contacted beams. This motion is in micro scale known as termed as micro - slip phenomenon [3].

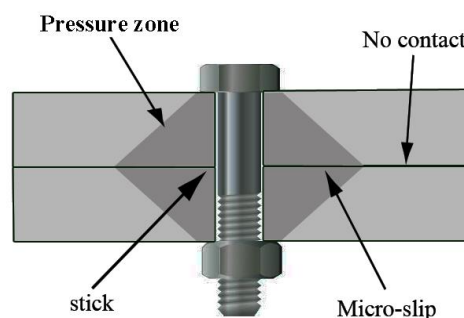

Figure (2): The micro-slip at the jointed interface

The technique of using bolts to suppress the structural vibration can be adopted in many applications related to the machines, building and vehicle structures. This technique can be implemented easily with relatively low cost.

In this paper, a cantilever beam of two beams joined together by bolts has been investigated numerically and experimentally. The theoretical analysis has been performed using ANSYS-Workbench to model the transient response of the two layers cantilever. Furthermore, an experimental rig was assembled to conduct the required experimental work.

## 2. Numerical Analysis formulation

The finite element method (FEM) has been developed to model and solve the complicated problems in most engineering fields. FEM based on ANSYS-Workbench 17.2 was employed in the present study. The proposed structure was created in a three dimensional model using: ANSYS-Workbench-“Geometry”- “Edit Geometry in Space Claim”. The created model can be seen in Fig. (3). This model is identical to that used in the experimental work.

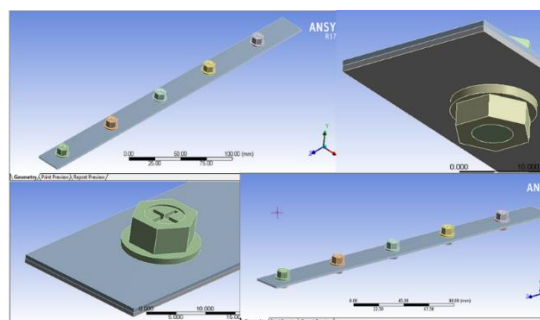

Figure (3): The modelled structure

The model includes two beams connected together with five bolts. Each beam owns a length 350 mm, width 25 mm and thickness 0.96 mm. Identical bolts were used, each has 9 gr weight. The bolts were located at five different positions: 20 mm, 70 mm, 160 mm, 230 mm, and 300 mm from the fixed end of the structure as shown in Fig. (3).



The model has the same material properties of the manufactured one, where these properties were identified experimentally. The beams were made from a Stainless Steel 304, and the bolts were modelled from structural steel, which its properties are provided by ANSYS software, thus

“Engineering Data” → “General Material” → “Add Material” → “Input Properties” → “Save Data”.

## 2.2 Static Analysis

The “Static Structural” tool is used to investigate the static cases for the created model. The first important task in simulation is defining the contact area to obtain reliable results, which represents the investigated case. ANSYS-workbench provides six types of contact, two of them represented the linear contact “Bonded”, “No Separation”, and the other represented the nonlinear contacts, which they are: “Frictionless”, “Rough”, “Frictional” and finally “Forced Frictional Sliding”. [4]. In the present study, the “Frictional” type was used to define the contact between the two beams. With other parameters such as: 0.2 coefficient friction, “symmetry” behaviour, “Augmented Lagrange” formulation and “Adjust to Touch” interface treatment.

The second task is choosing a suitable meshing for the created model, this job performed by sizing the mesh to 2 mm, according to following sequence: “Mesh” → “Sizing” → “Element Size” → “Input Number”.

The option “Automatic method” is inserted, and the “Automatic” is a good choice to select a suitable the mesh type for all parts of the model. The sequence can be as follows:

“Mesh” (right click) → “Automatic Method” → “Geometries” → “Method” (choose type).

Some surfaces of the modelled structure have a complicated boarder such as the bolts head face and nuts, and hence their mesh will be irregular. “Face Meshing” option is the solution for such problems, which can be applied as follows:

“Mesh” (right click) → “Face Meshing” (choose Areas). The meshed model can be seen in Fig. (4).

In “Analysis Setting”, two important parameters adjusted in “Solver Type” select “Direct” and operating the “Large Deflection”.

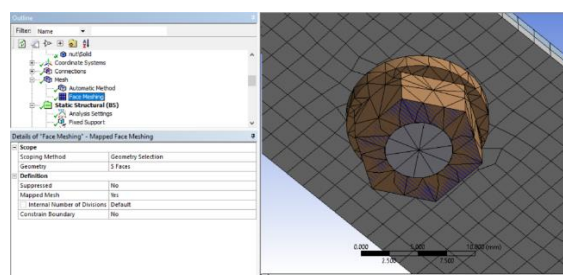

Figure (4): The face mesh enable

To applied boundary conditions on the model, the “Fixed Support” inserted to include one side area of each beams, thus the developed structure will be fixed as a cantilever beam.

Another boundary condition is required, which defines the interface between the two beams. This condition is accomplished by applying pressure at the interface. This pressure is applied using the command “Bolt pretension Order” as shown in Fig. (5).

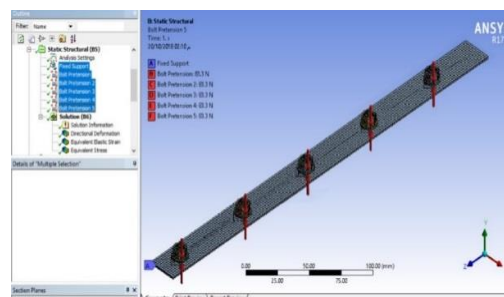

Figure (5): Boundary conditions insert

The “Bolt Pretension Order” applied to cylindrical shapes [5]. Four states are included in the “Bolt pretension Order” which they are “Load”, “Lock”, “Adjustment” and “Open”. “Load” state means that the input must be forced, “Lock” state means that the tightness of bolts is constant, “Adjustment” means that the input must be distance and open state which mean there is no pretension load. in this study chose “load”. The desired results can be obtained from the “Solution” as shown in Fig. (5).

## 2.3 Modal Analysis

In order to obtain the modal solution of the developed model, the “Modal” tool was linked to the “Static Structural” tool. In addition, the first three mode shapes have found according to following sequence.

(Shadow three frequencies (right click) → create mode shape)

## 2.4 Transient Structural

The transient solution of the developed model can be found from dragging the “Transient Structural” was linked to “Modal” tool.

In experimental work, the proposed cantilever structure is excited with initial displacement at its free end. Unfortunately, this initial displacement cannot be applied easily in Workbench. As an alternative, a pulse force is applied at the free end, which has the equivalent effect of the initial displacement of the structure. The setup required to obtain the transient solution and the pulsed force can be obtained from opening the “Details of Force” box, then selecting the “Tabular (Time)” option as shown in Fig. (6). It can be seen from this figure that the pulsed force is created from varying it from zero to 5 N in 0.05 Sec, and then returning it to zero in 0.05 Sec also.

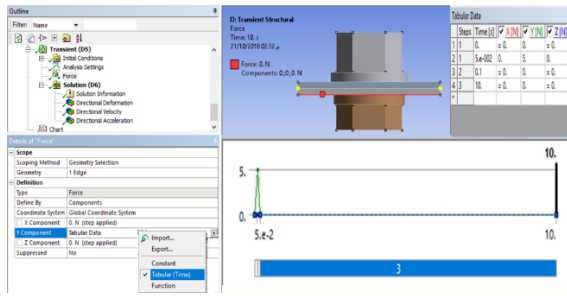

Figure (6): Shook force applying

### 3. Experimental Work

This study investigates the effect of bolts joint on the damping capacity of structures. Therefore, a simple structure consists of two cantilever beams hold together by five bolts was used. This structure was studying under free transverse vibration conditions as shown in Fig. (7).

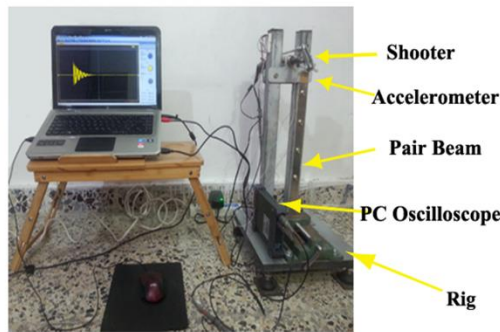

Figure (7): Experimental set up

The Rig contains four major parts: Platform, Bench vise, measuring system and shooting mechanism. The three dimensions accelerometer type (ADXL 326) with PC oscilloscope 20 KHz used to obtain the required results. This accelerometer fixed on the free end of the cantilever and connected with very thin wires to reduce the disturbances in measurements. The free end was drawn to have 3 cm deformation, and then it released to vibrate freely. The cantilever was left to oscillate until it stops. Meanwhile, the accelerometer records during the oscillation period.

The beams are stainless steel (304) of 196 GPa modulus of elasticity. They own the dimensions 0.96 mm thickness, 25 mm width and 400 mm length. Each beam contains five bolt holes of 6.6 mm in diameter as shown in Fig. (8).

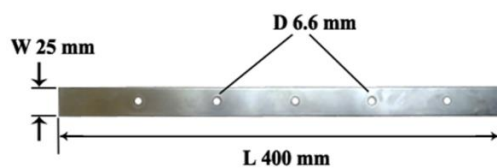

Figure (7): beam dimensions

They arranged as a layered cantilever beam when subjected to free vibration in transverse direction. The two contact surfaces at the interface will be pressed toward against each other when bolts are tightened, the nonlinear contact stiffness will cause to increase the structure overall stiffness while the nonlinear frictional force will cause to increase the overall damping of the structure.

The resulted stiffness of layered structure has been identified to be 20 N/m when bolts tighten lose, then increasing nonlinearly to maximum value 88.2 N/m as bolts tighten fastened as shown in Fig. (9).

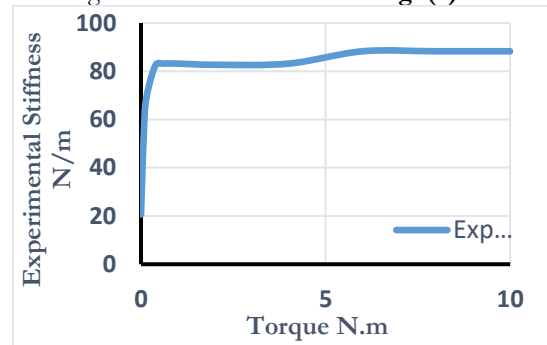

Figure (9): Experimental stiffness diagram

The resulted stiffness of layered structure was identified to be 20 N/m when bolts tighten loses; this stiffness is the same of that of one beam. This means that each layer of layered structure will vibrate independently when the bolts are loosened, because the two layers are in full slipping. Therefore, there is no damping due to friction whereas the structure will oscillate under the material damping only. With increasing the bolts tightening, the stiffness of structure is increased until it reaches its maximum value, which is about 88 N/m when the normal force equals to 8330 N where the two beams stick to be one because the static frictional force was immense and slipping is absent.

To derive a formula to calculate the nonlinear natural frequency of layered structure the nonlinear stiffness factor  $\alpha$  must be defined which is represented the fourth root for a ratio of experimental stiffness of layered structure  $k_{ex}$  to classical cantilever beam stiffness  $k_{ideal}$  the experimental frequency.

$$k_{ideal} = \frac{3EI}{l^3} \quad \dots (1)$$

$$\alpha = \sqrt[4]{\frac{k_{ex}}{k_{ideal}}} \quad \dots (2)$$

$$\omega_n = 3.52 \alpha^2 \sqrt{\frac{EI}{ml^3}} \quad \dots (3)$$

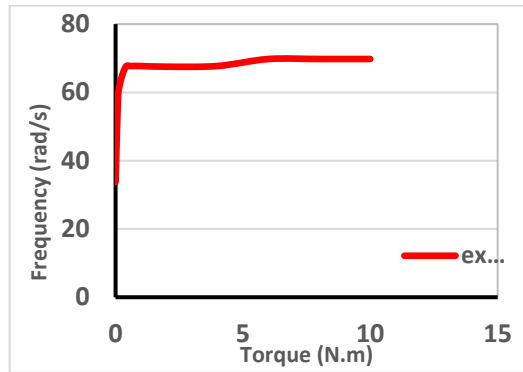

Figure (10): The stiffness behaviour of structure

The bolts' tightening has been controlled by use torque branch and by use the following equation:

$$N = 0.2DT \quad \dots (4)$$

Where  $N$ ,  $D$  and  $T$  represent the normal force applied by bolts, the diameter of bolts and torque of the tightening respectively.

Also, the experiments showed that the damping coefficient caused by the frictional force. Which increases from zero at bolts losing case to its maximum value when the normal force equals to 83.3 N. The normal force is further increased, the damping will be decreased to minimum value when the normal force is about 8330, as can be seen in Fig. (11).

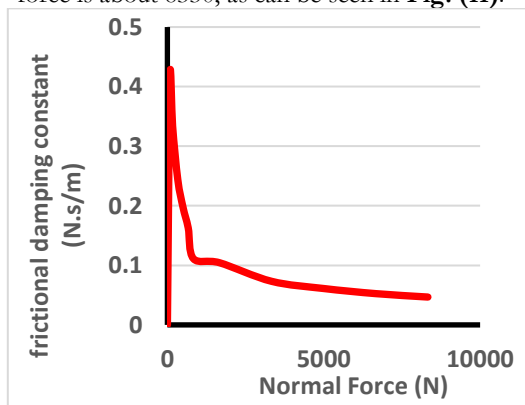

Figure (11): Frictional constant damping

Fig. (12) Shows a comparison between the experimental and numerical works at bolts tighten torques 0.1N m. Where the two oscillations have the same decay in vibrate therefore their amplitudes, at most time very closed. Where the damping ratio indefinite 0.049, 0.05 in Numerical and experimental result respectively.

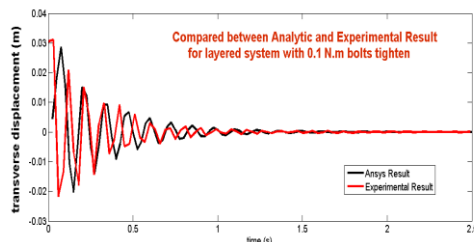

Figure (12): The displacement diagram at 0.1 N.m bolts tighten

Fig. (13) also Show a comparison between the experimental and Numerical works at bolts tighten torques 1N m. Where the two oscillations have the same decay in vibrate therefore their amplitudes at most time very closed. Where the damping ratio indefinite 0.0197, 0.02 in Numerical and experimental result respectively.

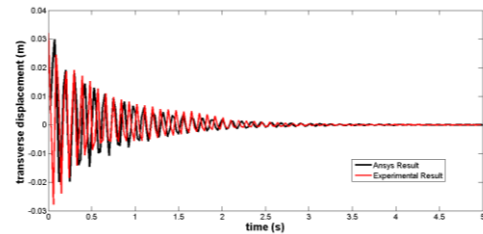

Figure (13): Displacement diagram at 1 N.m bolts tighten

Fig. (14) Shows the experimental and Numerical comparison respectively between the layered structure at bolts tighten torques 0.1N m and ordinary cantilever beam has same thick. Where the frictional effect in the layered cantilever beams clear and damping ratio of system improving from 0.004 to 0.05.

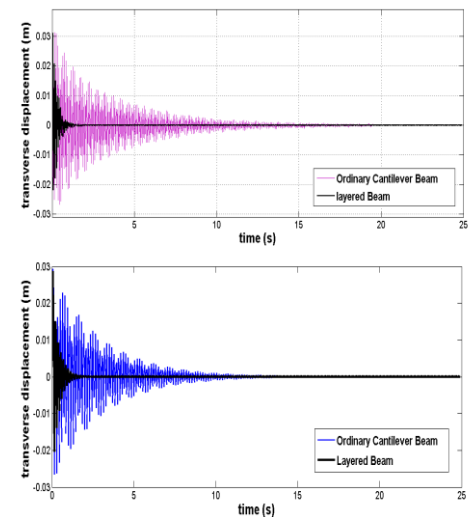

Figure (14): Comparison between layered and ordinary structure

## 4. Conclusions

The following remarks have been withdrawn from the present work are listed below

1. Modifying structure element from ordinary beam to layered beam lead to improving damping capacity 11 times and shorts the settling time 8.85 times.
2. Adjusting bolts tightening can be used to control vibration in structure, where present study shows that increasing bolts tightening leads to increase damping capacity from zero at loosen bolts, to increasing to 0.062 as bolts tightening to 0.1 N.m, after this point, the damping capacity decreases as bolts tightening increases.
3. Layered beam can be used in accurate applications that need variable stiffness Where the adjusting bolts increased stiffness from 17 N/m at loosen bolts to 92 N/m at bolt tightening 10 N.m.



4. In layered beam structure, each layer is oscillating independent on other when bolts are loosened where the present study shows that the frequency of structure 35 rad/s and damping ratio 0.008 this result agree with the results of one layer.
5. Proposed model gives good results that agreed with numerical results and experimental results.
6. ANSYS-model gives accurate description for behaviour of layered structure where the numerical results showed 40.8 rad/s frequency and 0.008 damping ratio in loosed bolts, 54.4 rad/s frequency and 0.062 damping ratio at bolts tightening 0.1 N.m.
7. The slipping has maximum value at the free end 0.12 mm this value decreases until it reach minimum value at free end 0.013 mm.

## 5. Reference

- [1] Nashif, A.D., Jones, D.I.G. and Henderson, J.P., 1985, *Vibration Damping*, John Wiley and Sons, NY.
- [2] L. Gaul & R. Nitsche 2001” *The Role of Friction in Mechanical Joints*” American Society of Mechanical Engineers, *Appl Mech Rev* vol 54, no 2.
- [3] Hamid Ahmadian, Hassan Jalali 2007” *Identification of bolted lap joints parameters in assembled structures*” *Mechanical Systems and Signal Processing* 21, pp 1041–1050.

- [4] ANSYS-Lecture 6” *Modelling connections*” introduction to ANSYS Mechanical.15 Release.
- [5] ANSYS- Chapter 4 “static structural analysis”. *Work bench introduction*12.0 Release.

## List of Symbols’

Symbol	Definition	unit
b	Width of beam	m
D	Diameter of the bolt	m
E	Modulus of Elasticity	N/m <sup>2</sup>
F <sub>(x,t)</sub>	Excitation force	N
h	Half thickness of beam	m
I	Second moment of inertia	m <sup>4</sup>
L	length	m
T	Torque tightening of the beam	N.m
u(x, t)	Longitudinal displacement	m
N	Normal force of the bolt	N
v(x, t)	Transverse displacement	m
x	The distance in direction of length	m
y	The distance from the centre line of interface	m
α	Nonlinear frequency factor	---
ω <sub>n</sub>	Natural frequency of structure	Rad/Sec